

NEON ENERGY USA INC. COMPUTER SIMULATION REPORT

SCOPE OF WORK

Ultra Outswing and Inswing Door- NFRC 100/200/500 simulations to determine U-Factor, Solar Heat Gain Coefficient, Visible Transmittance and Condensation Resistance ratings.

REPORT NUMBER

K0461.02-301-45 R3

TEST DATE

09/05/19

ISSUE DATE

09/05/19

REVISION DATE

12/18/20

RECORD RETENTION END DATE

09/05/24

PAGES

182

DOCUMENT CONTROL NUMBER

RT-R-AMER-Test-0600 (08/31/18)

©2017 INTERTEK

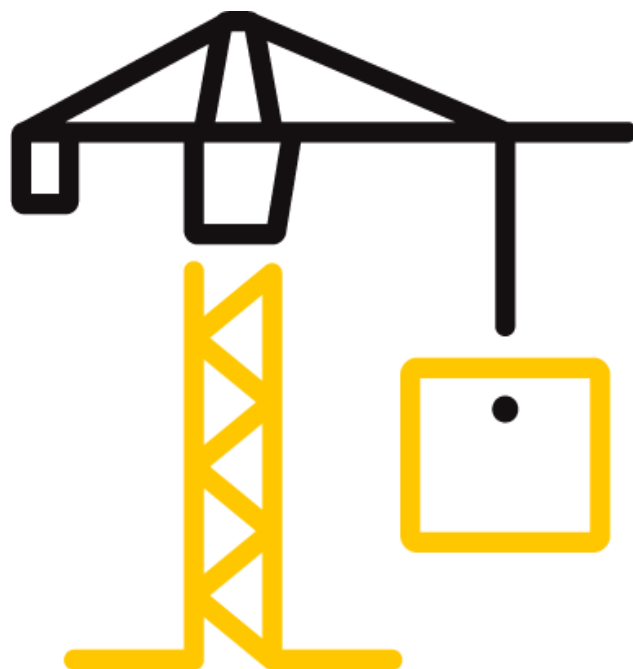

TEST REPORT FOR NEON ENERGY USA INC.

Report No: K0461.02-301-45 R3

Date: 12/18/20

REPORT ISSUED TO

NEON ENERGY USA INC.

4989 East La Palma Ave.

Anaheim, California 92807

SECTION 1

SUMMARY

SERIES/MODEL: Ultra Outswing and Inswing Door

Intertek Building & Construction (Intertek B&C) was contracted to perform U-Factor, Solar Heat Gain Coefficient, Visible Transmittance and Condensation Resistance simulations in accordance with the National Fenestration Rating Council (NFRC).

This report does not constitute certification of this product nor an opinion or endorsement by this laboratory. Intertek B&C will service this report for the entire test record retention period. The test record retention period ends five years after the test date. Test records, such as detailed drawings, datasheets, representative samples of test specimens, or other pertinent project documentation, will be retained for the entire test record retention period.

FOR INTERTEK B&C:

COMPLETED BY:	David L. Everitt
TITLE:	Simulation Technician, NFRC Certified Simulator
SIGNATURE:	
DATE:	12/18/20

REVIEWED BY:	Kenny C. White
TITLE:	Laboratory Manager, SIRC
SIGNATURE:	
DATE:	12/18/20

DLE:dle

This report is for the exclusive use of Intertek's Client and is provided pursuant to the agreement between Intertek and its Client. Intertek's responsibility and liability are limited to the terms and conditions of the agreement. Intertek assumes no liability to any party, other than to the Client in accordance with the agreement, for any loss, expense or damage occasioned by the use of this report. Only the Client is authorized to permit copying or distribution of this report and then only in its entirety. Any use of the Intertek name or one of its marks for the sale or advertisement of the tested material, product or service must first be approved in writing by Intertek. The observations and test results in this report are relevant only to the sample(s) tested. This report by itself does not imply that the material, product, or service is or has ever been under an Intertek certification program.

TEST REPORT FOR NEON ENERGY USA INC.

Report No: K0461.02-301-45 R3

Date: 12/18/20

SECTION 2

TEST METHODS

The products were evaluated in accordance with the following:

ANSI/NFRC 100-2017, Procedure for Determining Fenestration Product U-Factors

ANSI/NFRC 200-2017, Procedure for Determining Fenestration Product Solar Heat Gain Coefficient and Visible Transmittance at Normal Incidence

NFRC 500-2017, Procedure for Determining Fenestration Product Condensation Resistance Values

**Condensation Resistance results obtained from this procedure are for controlled laboratory conditions and do not include the effects of air movement through the specimen, solar radiation, and the thermal bridging that may occur due to the specific design and construction of the fenestration system opening.*

Ratings values included in this report are for submittals to an NFRC-licensed IA and are not meant to be used directly for labeling purposes. Only those values identified on a valid Certificate of Authorization (CA) by an NFRC accredited Inspection Agency (IA) are to be used for labeling purposes. The ratings values were rounded in accordance with NFRC 601, NFRC Unit and Measurement Policy.

Intertek B&C is an NFRC accredited simulation laboratory and all simulations were conducted in full compliance with NFRC approved procedures and specifications. The values included in this report are not considered in compliance with ANSI/NFRC 100, ANSI/NFRC 200, and/or NFRC 500 unless the associated validation test requirements have been satisfied, as applicable.

TEST REPORT FOR NEON ENERGY USA INC.

Report No: K0461.02-301-45 R3

Date: 12/18/20

SECTION 3

TEST PROCEDURE

The total product, including specific frame, spacer, and glass details, was modeled using NFRC approved software.

FRAME AND EDGE MODELING	THERM 7.4.4
CENTER-OF-GLASS MODELING	WINDOW 7.4.14
TOTAL PRODUCT CALCULATIONS	WINDOW 7.4.14
SPECTRAL DATA LIBRARY	IGDB 73.0

Modeling Assumptions / Technical Interpretations

Any modeling assumptions and technical interpretations required to model this product are listed below.

- 1) To prevent air infiltration, tape was applied to all interior sash crack locations.
- 2) Inswing and outswing profiles are separate products in the same product line per ANSI/NFRC 100-2017, Section 5.2.2.H.
- 3) Products with and without kickplate are separate products in the same product line per ANSI/NFRC 100-2017, Section 4.2.1.I.i.
- 4) 921, 922 and 923 frame profiles are grouped per ANSI/NFRC 100-2017, Section 4.2.1.H.ii. 923 frame is the group leader.
- 5) 925 sill modeled with non-kickplate options.
- 6) 932 and 925 sills are grouped with kickplate options per ANSI/NFRC 100-2017, Section 4.2.1.H.ii. 932 sill is the group leader.

SECTION 4

SIMULATION SPECIMEN DESCRIPTION

SERIES/MODEL	Ultra Outswing and Inswing Door
PRODUCT TYPE	Swinging Door, Single Leaf Entrance Door
FRAME MATERIAL	AT - Aluminum w/ Thermal Breaks - All Members
SASH MATERIAL	AT - Aluminum w/ Thermal Breaks - All Members
STANDARD SIZE	960mm x 2090mm
NFRC CPD NUMBER	NEO-K-19

TEST REPORT FOR NEON ENERGY USA INC.

Report No: K0461.02-301-45 R3

Date: 12/18/20

SECTION 4 (Continued)

SIMULATION SPECIMEN DESCRIPTION

SPACER OPTIONS			
TYPE	PRIMARY SEAL	SECONDARY SEAL	CODE
Aluminum Spacer	Butyl Rubber	Silicone	A1-D
Chromatech Spacer	Butyl Rubber	Silicone	TS-D
Swisspacer	Butyl Rubber	Silicone	TP-D

GRID OPTIONS		
GRID SIZE	GRID TYPE	GRID PATTERN
56mm x 43mm	Thermally Broken Aluminum TDL	NFRC Standard

REINFORCEMENT OPTIONS	
LOCATION	MATERIAL
None	-

GAS FILLING TECHNIQUE	
FILL TYPE	METHOD
90% Argon	Two-probe with concentration sensor

EDGE-OF-GLASS CONSTRUCTION	
INTERIOR CONDITION	EPDM gasket between the glass and glazing bead.
EXTERIOR CONDITION	EPDM gasket between the glass and glazing stop.

WEATHERSTRIPPING		
TYPE	QUANTITY	LOCATION
Mohair	2 Rows	Kickplate bottom rail
EPDM gasket	2 Rows	Head, jambs and sill without kickplate
EPDM gasket	1 Row	Top rail and jamb stiles

FRAME/SASH MATERIALS FINISH	
INTERIOR	Aluminum - Painted
EXTERIOR	Aluminum - Painted

VALIDATION MATRIX*	
PRODUCT LINE	REPORT NUMBER
None	-

**These products are part of a validation matrix. Only one is required for validation testing.*

TEST REPORT FOR NEON ENERGY USA INC.

Report No: K0461.02-301-45 R3

Date: 12/18/20

SECTION 5

SPECIALTY PRODUCTS TABLE

The specialty products method allows the manufacturer to determine the overall product SHGC and VT for any glazing option. The center of glass SHGC and/or VT must be determined using WINDOW 7.4.14. The method calculates overall product SHGC and VT indexed on center of glass properties. All values used in the calculations are truncated to six decimal place precision.

SHGC Table #1 - Inswing (No Kickplate)

	No Dividers	Dividers < 1	Dividers > 1
SHGC0	0.007247	0.010298	0.013136
SHGC1	0.713701	0.623529	0.539654
VT0	0.000000	0.000000	0.000000
VT1	0.706454	0.613230	0.526518

SHGC Table #2 - Inswing (Kickplate)

	No Dividers	Dividers < 1	Dividers > 1
SHGC0	0.012504	0.015425	0.018131
SHGC1	0.655813	0.570287	0.491057
VT0	0.000000	0.000000	0.000000
VT1	0.643309	0.554862	0.472927

SHGC Table #3 - Outswing (No Kickplate)

	No Dividers	Dividers < 1	Dividers > 1
SHGC0	0.014353	0.017250	0.019934
SHGC1	0.648379	0.562750	0.483419
VT0	0.000000	0.000000	0.000000
VT1	0.634027	0.545500	0.463485

SHGC Table #4 - Outswing (Kickplate)

	No Dividers	Dividers < 1	Dividers > 1
SHGC0	0.016928	0.019675	0.022208
SHGC1	0.595316	0.514131	0.439244
VT0	0.000000	0.000000	0.000000
VT1	0.578388	0.494456	0.417035

$$SHGC = SHGC0 + SHGCc (SHGC1 - SHGC0)$$

$$VT = VT0 + VTc (VT1 - VT0)$$

TEST REPORT FOR NEON ENERGY USA INC.

Report No: K0461.02-301-45 R3

Date: 12/18/20

SECTION 6

SIMULATION RESULTS

TOTAL PRODUCT CALCULATIONS (Ultra Outswing and Inswing Door)												
Option Number	Pane Thickness 1 (in)	Gap Width 1 (in)	Pane Thickness 2 (in)	Gap Width 2 (in)	Pane Thickness 3 (in)	Gap Width 3 (in)	Pane Thickness 4 (in)	Gap Fill	Low-e (Surface #)	Tint	Spacer	Grid Type
	U-Factor (Btu/Hr-Ft2-F)			Solar Heat Gain Coefficient (SHGC) Grids (None / <1 / >=1)				Visible Transmittance (VT) Grids (None / <1 / >=1)		Condensation Resistance (CR)		
1	Inswing: SNX 5123 / Arg / Clr - 28mm(6mm-6mm)											
	0.221	0.630	0.224					ARG90	0.021(#2)	CL	A1-D	N
	U-Factor 0.38			SHGC (N) 0.17				VT (N) 0.36		CR 48		
2	Inswing - NFRC Default: SNX 5123 / Arg / Clr - 28mm(6mm-6mm)											
	0.221	0.630	0.224					ARG90	0.021(#2)	CL	A1-D	T
	U-Factor 0.55			SHGC (>1) 0.13				VT (>1) 0.27		CR 47		
3	Inswing: SNX 6227 / Arg / Clr - 28mm(6mm-6mm)											
	0.221	0.630	0.224					ARG90	0.020(#2)	CL	A1-D	N
	U-Factor 0.38			SHGC (N) 0.19				VT (N) 0.43		CR 48		
4	Inswing - NFRC Default: SNX 6227 / Arg / Clr - 28mm(6mm-6mm)											
	0.221	0.630	0.224					ARG90	0.020(#2)	CL	A1-D	T
	U-Factor 0.55			SHGC (>1) 0.15				VT (>1) 0.32		CR 47		
5	Inswing: ClimaGuard Premium T / Arg / Clr - 27mm(6mm-5mm)											
	0.230	0.630	0.185					ARG90	0.035(#2)	CL	A1-D	N
	U-Factor 0.38			SHGC (N) 0.36				VT (N) 0.54		CR 48		
6	Inswing - NFRC Default: ClimaGuard Premium T / Arg / Clr - 27mm(6mm-5mm)											
	0.230	0.630	0.185					ARG90	0.035(#2)	CL	A1-D	T
	U-Factor 0.55			SHGC (>1) 0.28				VT (>1) 0.40		CR 47		
7	Inswing: SN 4023 / Arg / Clr - 27mm(6mm-5mm)											
	0.230	0.630	0.185					ARG90	0.026(#2)	CL	A1-D	N
	U-Factor 0.38			SHGC (N) 0.16				VT (N) 0.28		CR 48		
8	Inswing - NFRC Default: SN 4023 / Arg / Clr - 27mm(6mm-5mm)											
	0.230	0.630	0.185					ARG90	0.026(#2)	CL	A1-D	T
	U-Factor 0.55			SHGC (>1) 0.13				VT (>1) 0.21		CR 48		
9	Inswing: SN 5128 / Arg / Clr - 27mm(6mm-5mm)											
	0.230	0.630	0.185					ARG90	0.025(#2)	CL	A1-D	N
	U-Factor 0.38			SHGC (N) 0.19				VT (N) 0.36		CR 48		
10	Inswing - NFRC Default: SN 5128 / Arg / Clr - 27mm(6mm-5mm)											
	0.230	0.630	0.185					ARG90	0.025(#2)	CL	A1-D	T
	U-Factor 0.55			SHGC (>1) 0.15				VT (>1) 0.26		CR 48		

TEST REPORT FOR NEON ENERGY USA INC.

Report No: K0461.02-301-45 R3

Date: 12/18/20

SECTION 6 (Continued)

SIMULATION RESULTS

TOTAL PRODUCT CALCULATIONS (Ultra Outswing and Inswing Door)												
Option Number	Pane Thickness 1 (in)	Gap Width 1 (in)	Pane Thickness 2 (in)	Gap Width 2 (in)	Pane Thickness 3 (in)	Gap Width 3 (in)	Pane Thickness 4 (in)	Gap Fill	Low-e (Surface #)	Tint	Spacer	Grid Type
	U-Factor (Btu/Hr-Ft2-F)			Solar Heat Gain Coefficient (SHGC) Grids (None / <1 / >=1)				Visible Transmittance (VT) Grids (None / <1 / >=1)		Condensation Resistance (CR)		
11	Inswing: SN 6234 / Arg / Clr - 27mm(6mm-5mm)											
	0.230	0.630	0.185					ARG90	0.026(#2)	CL	A1-D	N
	U-Factor 0.38			SHGC (N) 0.22				VT (N) 0.44		CR 48		
12	Inswing - NFRC Default: SN 6234 / Arg / Clr - 27mm(6mm-5mm)											
	0.230	0.630	0.185					ARG90	0.026(#2)	CL	A1-D	T
	U-Factor 0.55			SHGC (>1) 0.17				VT (>1) 0.33		CR 48		
13	Inswing: SN 7037 / Arg / Clr - 27mm(6mm-5mm)											
	0.230	0.630	0.185					ARG90	0.022(#2)	CL	A1-D	N
	U-Factor 0.38			SHGC (N) 0.25				VT (N) 0.49		CR 48		
14	Inswing - NFRC Default: SN 7037 / Arg / Clr - 27mm(6mm-5mm)											
	0.230	0.630	0.185					ARG90	0.022(#2)	CL	A1-D	T
	U-Factor 0.55			SHGC (>1) 0.19				VT (>1) 0.36		CR 48		
15	Inswing: ClimaGuard Neutral 70 / Arg / Clr - 27mm(6mm-5mm)											
	0.226	0.630	0.185					ARG90	0.171(#2)	CL	A1-D	N
	U-Factor 0.41			SHGC (N) 0.39				VT (N) 0.48		CR 48		
16	Inswing - NFRC Default: ClimaGuard Neutral 70 / Arg / Clr - 27mm(6mm-5mm)											
	0.226	0.630	0.185					ARG90	0.171(#2)	CL	A1-D	T
	U-Factor 0.56			SHGC (>1) 0.30				VT (>1) 0.36		CR 46		
17	Inswing: SNX 6227 / Arg / Clr - 24mm(4mm-4mm)											
	0.151	0.630	0.154					ARG90	0.020(#2)	CL	A1-D	N
	U-Factor 0.38			SHGC (N) 0.19				VT (N) 0.44		CR 48		
18	Inswing - NFRC Default: SNX 6227 / Arg / Clr - 24mm(4mm-4mm)											
	0.151	0.630	0.154					ARG90	0.020(#2)	CL	A1-D	T
	U-Factor 0.54			SHGC (>1) 0.15				VT (>1) 0.33		CR 48		
19	Inswing: ClimaGuard Premium T / Arg / Clr - 24mm(4mm-4mm)											
	0.151	0.630	0.154					ARG90	0.035(#2)	CL	A1-D	N
	U-Factor 0.38			SHGC (N) 0.37				VT (N) 0.54		CR 48		
20	Inswing - NFRC Default: ClimaGuard Premium T / Arg / Clr - 24mm(4mm-4mm)											
	0.151	0.630	0.154					ARG90	0.035(#2)	CL	A1-D	T
	U-Factor 0.54			SHGC (>1) 0.28				VT (>1) 0.40		CR 48		

TEST REPORT FOR NEON ENERGY USA INC.

Report No: K0461.02-301-45 R3

Date: 12/18/20

SECTION 6 (Continued)

SIMULATION RESULTS

TOTAL PRODUCT CALCULATIONS (Ultra Outswing and Inswing Door)												
Option Number	Pane Thickness 1 (in)	Gap Width 1 (in)	Pane Thickness 2 (in)	Gap Width 2 (in)	Pane Thickness 3 (in)	Gap Width 3 (in)	Pane Thickness 4 (in)	Gap Fill	Low-e (Surface #)	Tint	Spacer	Grid Type
	U-Factor (Btu/Hr-Ft ² -F)			Solar Heat Gain Coefficient (SHGC) Grids (None / <1 / >=1)				Visible Transmittance (VT) Grids (None / <1 / >=1)		Condensation Resistance (CR)		
21	Inswing: SN 4023 / Arg / Clr - 24mm(4mm-4mm)											
	0.151	0.630	0.154					ARG90	0.026(#2)	CL	A1-D	N
	U-Factor 0.38			SHGC (N) 0.16				VT (N) 0.28		CR 48		
22	Inswing - NFRC Default: SN 4023 / Arg / Clr - 24mm(4mm-4mm)											
	0.151	0.630	0.154					ARG90	0.026(#2)	CL	A1-D	T
	U-Factor 0.54			SHGC (>1) 0.13				VT (>1) 0.21		CR 48		
23	Inswing: SN 5128 / Arg / Clr - 24mm(4mm-4mm)											
	0.151	0.630	0.154					ARG90	0.025(#2)	CL	A1-D	N
	U-Factor 0.38			SHGC (N) 0.19				VT (N) 0.36		CR 48		
24	Inswing - NFRC Default: SN 5128 / Arg / Clr - 24mm(4mm-4mm)											
	0.151	0.630	0.154					ARG90	0.025(#2)	CL	A1-D	T
	U-Factor 0.54			SHGC (>1) 0.15				VT (>1) 0.27		CR 48		
25	Inswing: SN 6234 / Arg / Clr - 24mm(4mm-4mm)											
	0.151	0.630	0.154					ARG90	0.026(#2)	CL	A1-D	N
	U-Factor 0.38			SHGC (N) 0.22				VT (N) 0.44		CR 48		
26	Inswing - NFRC Default: SN 6234 / Arg / Clr - 24mm(4mm-4mm)											
	0.151	0.630	0.154					ARG90	0.026(#2)	CL	A1-D	T
	U-Factor 0.54			SHGC (>1) 0.17				VT (>1) 0.33		CR 48		
27	Inswing: SN 7037 / Arg / Clr - 24mm(4mm-4mm)											
	0.151	0.630	0.154					ARG90	0.022(#2)	CL	A1-D	N
	U-Factor 0.38			SHGC (N) 0.25				VT (N) 0.50		CR 48		
28	Inswing - NFRC Default: SN 7037 / Arg / Clr - 24mm(4mm-4mm)											
	0.151	0.630	0.154					ARG90	0.022(#2)	CL	A1-D	T
	U-Factor 0.54			SHGC (>1) 0.19				VT (>1) 0.37		CR 48		
29	Inswing: ClimaGuard Neutral 70 / Arg / Clr - 24mm(4mm-4mm)											
	0.148	0.630	0.154					ARG90	0.171(#2)	CL	A1-D	N
	U-Factor 0.41			SHGC (N) 0.40				VT (N) 0.49		CR 48		
30	Inswing - NFRC Default: ClimaGuard Neutral 70 / Arg / Clr - 24mm(4mm-4mm)											
	0.148	0.630	0.154					ARG90	0.171(#2)	CL	A1-D	T
	U-Factor 0.56			SHGC (>1) 0.30				VT (>1) 0.36		CR 48		

TEST REPORT FOR NEON ENERGY USA INC.

Report No: K0461.02-301-45 R3

Date: 12/18/20

SECTION 6 (Continued)

SIMULATION RESULTS

TOTAL PRODUCT CALCULATIONS (Ultra Outswing and Inswing Door)												
Option Number	Pane Thickness 1 (in)	Gap Width 1 (in)	Pane Thickness 2 (in)	Gap Width 2 (in)	Pane Thickness 3 (in)	Gap Width 3 (in)	Pane Thickness 4 (in)	Gap Fill	Low-e (Surface #)	Tint	Spacer	Grid Type
	U-Factor (Btu/Hr-Ft2-F)		Solar Heat Gain Coefficient (SHGC) Grids (None / <1 / >=1)				Visible Transmittance (VT) Grids (None / <1 / >=1)		Condensation Resistance (CR)			
31	Inswing: ClimaGuard Neutral 70 / Arg / Clr - 28mm(6mm-5mm)											
	0.226	0.670	0.185					ARG90	0.171(#2)	CL	A1-D	N
	U-Factor 0.41		SHGC (N) 0.39				VT (N) 0.48		CR 47			
32	Inswing - NFRC Default: ClimaGuard Neutral 70 / Arg / Clr - 28mm(6mm-5mm)											
	0.226	0.670	0.185					ARG90	0.171(#2)	CL	A1-D	T
	U-Factor 0.57		SHGC (>1) 0.30				VT (>1) 0.36		CR 46			
33	Inswing: ClimaGuard Neutral 70 / Arg / Clr - 28mm(4mm-4mm)											
	0.226	0.787	0.185					ARG90	0.171(#2)	CL	A1-D	N
	U-Factor 0.42		SHGC (N) 0.39				VT (N) 0.48		CR 46			
34	Inswing - NFRC Default: ClimaGuard Neutral 70 / Arg / Clr - 28mm(4mm-4mm)											
	0.226	0.787	0.185					ARG90	0.171(#2)	CL	A1-D	T
	U-Factor 0.58		SHGC (>1) 0.30				VT (>1) 0.36		CR 44			
35	Inswing: SNX 6227 / Arg / SNX 6227 / Arg / Clr - 36mm(4mm-4mm-4mm)											
	0.151	0.470	0.151	0.470	0.154			ARG90	0.020(#2) / 0.020(#4)	CL	TS-D	N
	U-Factor 0.27		SHGC (N) 0.15				VT (N) 0.31		CR 51			
36	Inswing: SNX 6227 / Arg / SNX 6227 / Arg / Clr - 41mm(6mm-6mm-5mm)											
	0.221	0.470	0.221	0.470	0.185			ARG90	0.020(#2) / 0.020(#4)	CL	TS-D	N
	U-Factor 0.27		SHGC (N) 0.15				VT (N) 0.30		CR 50			
37	Inswing: SNX 5123 / Arg / SNX 5123 / Arg / Clr - 41mm(6mm-6mm-5mm)											
	0.221	0.470	0.221	0.470	0.185			ARG90	0.021(#2) / 0.021(#4)	CL	TS-D	N
	U-Factor 0.27		SHGC (N) 0.12				VT (N) 0.21		CR 50			
38	Inswing: SNX 5123 / Arg / 3mmClr-030PVB-3mmIS20 - 28mm (6mm-6mm)											
	0.221	0.625	0.264					ARG90	0.021(#2) / 0.198(#4)	CL	TS-D	N
	U-Factor 0.33		SHGC (N) 0.16				VT (N) 0.35		CR 50			
39	Inswing - NFRC Default: SNX 5123 / Arg / 3mmClr-030PVB-3mmIS20 - 28mm (6mm-6mm)											
	0.221	0.625	0.264					ARG90	0.021(#2) / 0.198(#4)	CL	TS-D	T
	U-Factor 0.45		SHGC (>1) 0.13				VT (>1) 0.26		CR 50			
40	Inswing - 1 Horizontal TDL: SNX 5123 / Arg / Clr - 28mm(6mm-6mm)											
	0.221	0.630	0.224					ARG90	0.021(#2)	CL	A1-D	T
	U-Factor 0.39		SHGC (>1) 0.13				VT (>1) 0.27		CR 48			

TEST REPORT FOR NEON ENERGY USA INC.

Report No: K0461.02-301-45 R3

Date: 12/18/20

SECTION 6 (Continued)

SIMULATION RESULTS

TOTAL PRODUCT CALCULATIONS (Ultra Outswing and Inswing Door)												
Option Number	Pane Thickness 1 (in)	Gap Width 1 (in)	Pane Thickness 2 (in)	Gap Width 2 (in)	Pane Thickness 3 (in)	Gap Width 3 (in)	Pane Thickness 4 (in)	Gap Fill	Low-e (Surface #)	Tint	Spacer	Grid Type
	U-Factor (Btu/Hr-Ft ² -F)			Solar Heat Gain Coefficient (SHGC) Grids (None / <1 / >=1)				Visible Transmittance (VT) Grids (None / <1 / >=1)		Condensation Resistance (CR)		
41	Inswing - 1 Horizontal TDL: SNX 6227 / Arg / Clr - 28mm(6mm-6mm)											
	0.221	0.630	0.224					ARG90	0.020(#2)	CL	A1-D	T
	U-Factor 0.39			SHGC (>1) 0.15				VT (>1) 0.32		CR 48		
42	Inswing - 1 Horizontal TDL: ClimaGuard Premium T / Arg / Clr - 27mm(6mm-5mm)											
	0.230	0.630	0.185					ARG90	0.035(#2)	CL	A1-D	T
	U-Factor 0.40			SHGC (>1) 0.28				VT (>1) 0.40		CR 48		
43	Inswing - 1 Horizontal TDL: SN 4023 / Arg / Clr - 27mm(6mm-5mm)											
	0.230	0.630	0.185					ARG90	0.026(#2)	CL	A1-D	T
	U-Factor 0.39			SHGC (>1) 0.13				VT (>1) 0.21		CR 48		
44	Inswing - 1 Horizontal TDL: SN 5128 / Arg / Clr - 27mm(6mm-5mm)											
	0.230	0.630	0.185					ARG90	0.025(#2)	CL	A1-D	T
	U-Factor 0.39			SHGC (>1) 0.15				VT (>1) 0.26		CR 48		
45	Inswing - 1 Horizontal TDL: SN 6234 / Arg / Clr - 27mm(6mm-5mm)											
	0.230	0.630	0.185					ARG90	0.026(#2)	CL	A1-D	T
	U-Factor 0.39			SHGC (>1) 0.17				VT (>1) 0.33		CR 48		
46	Inswing - 1 Horizontal TDL: SN 7037 / Arg / Clr - 27mm(6mm-5mm)											
	0.230	0.630	0.185					ARG90	0.022(#2)	CL	A1-D	T
	U-Factor 0.39			SHGC (>1) 0.19				VT (>1) 0.36		CR 48		
47	Inswing - 1 Horizontal TDL: ClimaGuard Neutral 70 / Arg / Clr - 27mm(6mm-5mm)											
	0.226	0.630	0.185					ARG90	0.171(#2)	CL	A1-D	T
	U-Factor 0.42			SHGC (>1) 0.30				VT (>1) 0.36		CR 48		
48	Inswing - 1 Horizontal TDL: SNX 6227 / Arg / Clr - 24mm(4mm-4mm)											
	0.151	0.630	0.154					ARG90	0.020(#2)	CL	A1-D	T
	U-Factor 0.39			SHGC (>1) 0.15				VT (>1) 0.33		CR 48		
49	Inswing - 1 Horizontal TDL: ClimaGuard Premium T / Arg / Clr - 24mm(4mm-4mm)											
	0.151	0.630	0.154					ARG90	0.035(#2)	CL	A1-D	T
	U-Factor 0.39			SHGC (>1) 0.28				VT (>1) 0.40		CR 48		
50	Inswing - 1 Horizontal TDL: SN 4023 / Arg / Clr - 24mm(4mm-4mm)											
	0.151	0.630	0.154					ARG90	0.026(#2)	CL	A1-D	T
	U-Factor 0.39			SHGC (>1) 0.13				VT (>1) 0.21		CR 48		

TEST REPORT FOR NEON ENERGY USA INC.

Report No: K0461.02-301-45 R3

Date: 12/18/20

SECTION 6 (Continued)

SIMULATION RESULTS

TOTAL PRODUCT CALCULATIONS (Ultra Outswing and Inswing Door)												
Option Number	Pane Thickness 1 (in)	Gap Width 1 (in)	Pane Thickness 2 (in)	Gap Width 2 (in)	Pane Thickness 3 (in)	Gap Width 3 (in)	Pane Thickness 4 (in)	Gap Fill	Low-e (Surface #)	Tint	Spacer	Grid Type
	U-Factor (Btu/Hr-Ft2-F)			Solar Heat Gain Coefficient (SHGC) Grids (None / <1 / >=1)				Visible Transmittance (VT) Grids (None / <1 / >=1)		Condensation Resistance (CR)		
51	Inswing - 1 Horizontal TDL: SN 5128 / Arg / Clr - 24mm(4mm-4mm)											
	0.151	0.630	0.154					ARG90	0.025(#2)	CL	A1-D	T
	U-Factor 0.39			SHGC (>1) 0.15				VT (>1) 0.27		CR 48		
52	Inswing - 1 Horizontal TDL: SN 6234 / Arg / Clr - 24mm(4mm-4mm)											
	0.151	0.630	0.154					ARG90	0.026(#2)	CL	A1-D	T
	U-Factor 0.39			SHGC (>1) 0.17				VT (>1) 0.33		CR 48		
53	Inswing - 1 Horizontal TDL: SN 7037 / Arg / Clr - 24mm(4mm-4mm)											
	0.151	0.630	0.154					ARG90	0.022(#2)	CL	A1-D	T
	U-Factor 0.39			SHGC (>1) 0.19				VT (>1) 0.37		CR 48		
54	Inswing - 1 Horizontal TDL: ClimaGuard Neutral 70 / Arg / Clr - 24mm(4mm-4mm)											
	0.148	0.630	0.154					ARG90	0.171(#2)	CL	A1-D	T
	U-Factor 0.42			SHGC (>1) 0.30				VT (>1) 0.36		CR 48		
55	Inswing - 1 Horizontal TDL: ClimaGuard Neutral 70 / Arg / Clr - 28mm(6mm-5mm)											
	0.226	0.670	0.185					ARG90	0.171(#2)	CL	A1-D	T
	U-Factor 0.43			SHGC (>1) 0.30				VT (>1) 0.36		CR 47		
56	Inswing - 1 Horizontal TDL: ClimaGuard Neutral 70 / Arg / Clr - 28mm(4mm-4mm)											
	0.226	0.787	0.185					ARG90	0.171(#2)	CL	A1-D	T
	U-Factor 0.43			SHGC (>1) 0.30				VT (>1) 0.36		CR 46		
57	Inswing - 1 Horizontal TDL: SNX 5123 / Arg / 3mmClr-030PVB-3mmIS20 - 28mm (6mm-6mm)											
	0.221	0.625	0.264					ARG90	0.021(#2) / 0.198(#4)	CL	TS-D	T
	U-Factor 0.34			SHGC (>1) 0.13				VT (>1) 0.26		CR 50		
58	Inswing - 2 Horizontal TDLS: SNX 5123 / Arg / Clr - 28mm(6mm-6mm)											
	0.221	0.630	0.224					ARG90	0.021(#2)	CL	A1-D	T
	U-Factor 0.41			SHGC (>1) 0.13				VT (>1) 0.27		CR 48		
59	Inswing - 2 Horizontal TDLS: SNX 6227 / Arg / Clr - 28mm(6mm-6mm)											
	0.221	0.630	0.224					ARG90	0.020(#2)	CL	A1-D	T
	U-Factor 0.41			SHGC (>1) 0.15				VT (>1) 0.32		CR 48		
60	Inswing - 2 Horizontal TDLS: ClimaGuard Premium T / Arg / Clr - 27mm(6mm-5mm)											
	0.230	0.630	0.185					ARG90	0.035(#2)	CL	A1-D	T
	U-Factor 0.41			SHGC (>1) 0.28				VT (>1) 0.40		CR 48		

TEST REPORT FOR NEON ENERGY USA INC.

Report No: K0461.02-301-45 R3

Date: 12/18/20

SECTION 6 (Continued) SIMULATION RESULTS

TOTAL PRODUCT CALCULATIONS (Ultra Outswing and Inswing Door)												
Option Number	Pane Thickness 1 (in)	Gap Width 1 (in)	Pane Thickness 2 (in)	Gap Width 2 (in)	Pane Thickness 3 (in)	Gap Width 3 (in)	Pane Thickness 4 (in)	Gap Fill	Low-e (Surface #)	Tint	Spacer	Grid Type
	U-Factor (Btu/Hr-Ft2-F)			Solar Heat Gain Coefficient (SHGC) Grids (None / <1 / >=1)				Visible Transmittance (VT) Grids (None / <1 / >=1)		Condensation Resistance (CR)		
61	Inswing - 2 Horizontal TDs: SN 4023 / Arg / Clr - 27mm(6mm-5mm)											
	0.230	0.630	0.185					ARG90	0.026(#2)	CL	A1-D	T
	U-Factor 0.41			SHGC (>1) 0.13				VT (>1) 0.21		CR 48		
62	Inswing - 2 Horizontal TDs: SN 5128 / Arg / Clr - 27mm(6mm-5mm)											
	0.230	0.630	0.185					ARG90	0.025(#2)	CL	A1-D	T
	U-Factor 0.41			SHGC (>1) 0.15				VT (>1) 0.26		CR 48		
63	Inswing - 2 Horizontal TDs: SN 6234 / Arg / Clr - 27mm(6mm-5mm)											
	0.230	0.630	0.185					ARG90	0.026(#2)	CL	A1-D	T
	U-Factor 0.41			SHGC (>1) 0.17				VT (>1) 0.33		CR 48		
64	Inswing - 2 Horizontal TDs: SN 7037 / Arg / Clr - 27mm(6mm-5mm)											
	0.230	0.630	0.185					ARG90	0.022(#2)	CL	A1-D	T
	U-Factor 0.41			SHGC (>1) 0.19				VT (>1) 0.36		CR 48		
65	Inswing - 2 Horizontal TDs: ClimaGuard Neutral 70 / Arg / Clr - 27mm(6mm-5mm)											
	0.226	0.630	0.185					ARG90	0.171(#2)	CL	A1-D	T
	U-Factor 0.44			SHGC (>1) 0.30				VT (>1) 0.36		CR 48		
66	Inswing - 2 Horizontal TDs: SNX 6227 / Arg / Clr - 24mm(4mm-4mm)											
	0.151	0.630	0.154					ARG90	0.020(#2)	CL	A1-D	T
	U-Factor 0.40			SHGC (>1) 0.15				VT (>1) 0.33		CR 48		
67	Inswing - 2 Horizontal TDs: ClimaGuard Premium T / Arg / Clr - 24mm(4mm-4mm)											
	0.151	0.630	0.154					ARG90	0.035(#2)	CL	A1-D	T
	U-Factor 0.41			SHGC (>1) 0.28				VT (>1) 0.40		CR 48		
68	Inswing - 2 Horizontal TDs: SN 4023 / Arg / Clr - 24mm(4mm-4mm)											
	0.151	0.630	0.154					ARG90	0.026(#2)	CL	A1-D	T
	U-Factor 0.41			SHGC (>1) 0.13				VT (>1) 0.21		CR 48		
69	Inswing - 2 Horizontal TDs: SN 5128 / Arg / Clr - 24mm(4mm-4mm)											
	0.151	0.630	0.154					ARG90	0.025(#2)	CL	A1-D	T
	U-Factor 0.41			SHGC (>1) 0.15				VT (>1) 0.27		CR 48		
70	Inswing - 2 Horizontal TDs: SN 6234 / Arg / Clr - 24mm(4mm-4mm)											
	0.151	0.630	0.154					ARG90	0.026(#2)	CL	A1-D	T
	U-Factor 0.41			SHGC (>1) 0.17				VT (>1) 0.33		CR 48		

TEST REPORT FOR NEON ENERGY USA INC.

Report No: K0461.02-301-45 R3

Date: 12/18/20

SECTION 6 (Continued)

SIMULATION RESULTS

TOTAL PRODUCT CALCULATIONS (Ultra Outswing and Inswing Door)												
Option Number	Pane Thickness 1 (in)	Gap Width 1 (in)	Pane Thickness 2 (in)	Gap Width 2 (in)	Pane Thickness 3 (in)	Gap Width 3 (in)	Pane Thickness 4 (in)	Gap Fill	Low-e (Surface #)	Tint	Spacer	Grid Type
	U-Factor (Btu/Hr-Ft2-F)			Solar Heat Gain Coefficient (SHGC) Grids (None / <1 / >=1)				Visible Transmittance (VT) Grids (None / <1 / >=1)		Condensation Resistance (CR)		
71	Inswing - 2 Horizontal TDs: SN 7037 / Arg / Clr - 24mm(4mm-4mm)											
	0.151	0.630	0.154					ARG90	0.022(#2)	CL	A1-D	T
	U-Factor 0.41			SHGC (>1) 0.19				VT (>1) 0.37		CR 48		
72	Inswing - 2 Horizontal TDs: ClimaGuard Neutral 70 / Arg / Clr - 24mm(4mm-4mm)											
	0.148	0.630	0.154					ARG90	0.171(#2)	CL	A1-D	T
	U-Factor 0.44			SHGC (>1) 0.30				VT (>1) 0.36		CR 48		
73	Inswing - 2 Horizontal TDs: ClimaGuard Neutral 70 / Arg / Clr - 28mm(6mm-5mm)											
	0.226	0.670	0.185					ARG90	0.171(#2)	CL	A1-D	T
	U-Factor 0.44			SHGC (>1) 0.30				VT (>1) 0.36		CR 47		
74	Inswing - 2 Horizontal TDs: ClimaGuard Neutral 70 / Arg / Clr - 28mm(4mm-4mm)											
	0.226	0.787	0.185					ARG90	0.171(#2)	CL	A1-D	T
	U-Factor 0.45			SHGC (>1) 0.30				VT (>1) 0.36		CR 46		
75	Inswing - 2 Horizontal TDs: SNX 5123 / Arg / 3mmClr-030PVB-3mmIS20 - 28mm (6mm-6mm)											
	0.221	0.625	0.264					ARG90	0.021(#2) / 0.198(#4)	CL	TS-D	T
	U-Factor 0.35			SHGC (>1) 0.13				VT (>1) 0.26		CR 50		
76	Inswing - 3 Horizontal TDs: SNX 5123 / Arg / Clr - 28mm(6mm-6mm)											
	0.221	0.630	0.224					ARG90	0.021(#2)	CL	A1-D	T
	U-Factor 0.42			SHGC (>1) 0.13				VT (>1) 0.27		CR 48		
77	Inswing - 3 Horizontal TDs: SNX 6227 / Arg / Clr - 28mm(6mm-6mm)											
	0.221	0.630	0.224					ARG90	0.020(#2)	CL	A1-D	T
	U-Factor 0.42			SHGC (>1) 0.15				VT (>1) 0.32		CR 48		
78	Inswing - 3 Horizontal TDs: ClimaGuard Premium T / Arg / Clr - 27mm(6mm-5mm)											
	0.230	0.630	0.185					ARG90	0.035(#2)	CL	A1-D	T
	U-Factor 0.42			SHGC (>1) 0.28				VT (>1) 0.40		CR 48		
79	Inswing - 3 Horizontal TDs: SN 4023 / Arg / Clr - 27mm(6mm-5mm)											
	0.230	0.630	0.185					ARG90	0.026(#2)	CL	A1-D	T
	U-Factor 0.42			SHGC (>1) 0.13				VT (>1) 0.21		CR 48		
80	Inswing - 3 Horizontal TDs: SN 5128 / Arg / Clr - 27mm(6mm-5mm)											
	0.230	0.630	0.185					ARG90	0.025(#2)	CL	A1-D	T
	U-Factor 0.42			SHGC (>1) 0.15				VT (>1) 0.26		CR 48		

TEST REPORT FOR NEON ENERGY USA INC.

Report No: K0461.02-301-45 R3

Date: 12/18/20

SECTION 6 (Continued) SIMULATION RESULTS

TOTAL PRODUCT CALCULATIONS (Ultra Outswing and Inswing Door)												
Option Number	Pane Thickness 1 (in)	Gap Width 1 (in)	Pane Thickness 2 (in)	Gap Width 2 (in)	Pane Thickness 3 (in)	Gap Width 3 (in)	Pane Thickness 4 (in)	Gap Fill	Low-e (Surface #)	Tint	Spacer	Grid Type
	U-Factor (Btu/Hr-Ft2-F)			Solar Heat Gain Coefficient (SHGC) Grids (None / <1 / >=1)				Visible Transmittance (VT) Grids (None / <1 / >=1)		Condensation Resistance (CR)		
81	Inswing - 3 Horizontal TDs: SN 6234 / Arg / Clr - 27mm(6mm-5mm)											
	0.230	0.630	0.185					ARG90	0.026(#2)	CL	A1-D	T
	U-Factor 0.42			SHGC (>1) 0.17				VT (>1) 0.33		CR 48		
82	Inswing - 3 Horizontal TDs: SN 7037 / Arg / Clr - 27mm(6mm-5mm)											
	0.230	0.630	0.185					ARG90	0.022(#2)	CL	A1-D	T
	U-Factor 0.42			SHGC (>1) 0.19				VT (>1) 0.36		CR 48		
83	Inswing - 3 Horizontal TDs: ClimaGuard Neutral 70 / Arg / Clr - 27mm(6mm-5mm)											
	0.226	0.630	0.185					ARG90	0.171(#2)	CL	A1-D	T
	U-Factor 0.45			SHGC (>1) 0.30				VT (>1) 0.36		CR 48		
84	Inswing - 3 Horizontal TDs: SNX 6227 / Arg / Clr - 24mm(4mm-4mm)											
	0.151	0.630	0.154					ARG90	0.020(#2)	CL	A1-D	T
	U-Factor 0.42			SHGC (>1) 0.15				VT (>1) 0.33		CR 48		
85	Inswing - 3 Horizontal TDs: ClimaGuard Premium T / Arg / Clr - 24mm(4mm-4mm)											
	0.151	0.630	0.154					ARG90	0.035(#2)	CL	A1-D	T
	U-Factor 0.42			SHGC (>1) 0.28				VT (>1) 0.40		CR 48		
86	Inswing - 3 Horizontal TDs: SN 4023 / Arg / Clr - 24mm(4mm-4mm)											
	0.151	0.630	0.154					ARG90	0.026(#2)	CL	A1-D	T
	U-Factor 0.42			SHGC (>1) 0.13				VT (>1) 0.21		CR 48		
87	Inswing - 3 Horizontal TDs: SN 5128 / Arg / Clr - 24mm(4mm-4mm)											
	0.151	0.630	0.154					ARG90	0.025(#2)	CL	A1-D	T
	U-Factor 0.42			SHGC (>1) 0.15				VT (>1) 0.27		CR 48		
88	Inswing - 3 Horizontal TDs: SN 6234 / Arg / Clr - 24mm(4mm-4mm)											
	0.151	0.630	0.154					ARG90	0.026(#2)	CL	A1-D	T
	U-Factor 0.42			SHGC (>1) 0.17				VT (>1) 0.33		CR 48		
89	Inswing - 3 Horizontal TDs: SN 7037 / Arg / Clr - 24mm(4mm-4mm)											
	0.151	0.630	0.154					ARG90	0.022(#2)	CL	A1-D	T
	U-Factor 0.42			SHGC (>1) 0.19				VT (>1) 0.37		CR 48		
90	Inswing - 3 Horizontal TDs: ClimaGuard Neutral 70 / Arg / Clr - 24mm(4mm-4mm)											
	0.148	0.630	0.154					ARG90	0.171(#2)	CL	A1-D	T
	U-Factor 0.45			SHGC (>1) 0.30				VT (>1) 0.36		CR 48		

TEST REPORT FOR NEON ENERGY USA INC.

Report No: K0461.02-301-45 R3

Date: 12/18/20

SECTION 6 (Continued) SIMULATION RESULTS

TOTAL PRODUCT CALCULATIONS (Ultra Outswing and Inswing Door)												
Option Number	Pane Thickness 1 (in)	Gap Width 1 (in)	Pane Thickness 2 (in)	Gap Width 2 (in)	Pane Thickness 3 (in)	Gap Width 3 (in)	Pane Thickness 4 (in)	Gap Fill	Low-e (Surface #)	Tint	Spacer	Grid Type
	U-Factor (Btu/Hr-Ft ² -F)			Solar Heat Gain Coefficient (SHGC) Grids (None / <1 / >=1)				Visible Transmittance (VT) Grids (None / <1 / >=1)		Condensation Resistance (CR)		
91	Inswing - 3 Horizontal TDs: ClimaGuard Neutral 70 / Arg / Clr - 28mm(6mm-5mm)											
	0.226	0.670	0.185					ARG90	0.171(#2)	CL	A1-D	T
	U-Factor 0.45			SHGC (>1) 0.30				VT (>1) 0.36		CR 47		
92	Inswing - 3 Horizontal TDs: ClimaGuard Neutral 70 / Arg / Clr - 28mm(4mm-4mm)											
	0.226	0.787	0.185					ARG90	0.171(#2)	CL	A1-D	T
	U-Factor 0.46			SHGC (>1) 0.30				VT (>1) 0.36		CR 46		
93	Inswing - 3 Horizontal TDs: SNX 5123 / Arg / 3mmClr-030PVB-3mmIS20 - 28mm (6mm-6mm)											
	0.221	0.625	0.264					ARG90	0.021(#2) / 0.198(#4)	CL	TS-D	T
	U-Factor 0.36			SHGC (>1) 0.13				VT (>1) 0.26		CR 50		
94	Inswing - 4 Horizontal TDs: SNX 5123 / Arg / Clr - 28mm(6mm-6mm)											
	0.221	0.630	0.224					ARG90	0.021(#2)	CL	A1-D	T
	U-Factor 0.44			SHGC (>1) 0.13				VT (>1) 0.27		CR 48		
95	Inswing - 4 Horizontal TDs: SNX 6227 / Arg / Clr - 28mm(6mm-6mm)											
	0.221	0.630	0.224					ARG90	0.020(#2)	CL	A1-D	T
	U-Factor 0.44			SHGC (>1) 0.15				VT (>1) 0.32		CR 48		
96	Inswing - 4 Horizontal TDs: ClimaGuard Premium T / Arg / Clr - 27mm(6mm-5mm)											
	0.230	0.630	0.185					ARG90	0.035(#2)	CL	A1-D	T
	U-Factor 0.44			SHGC (>1) 0.28				VT (>1) 0.40		CR 48		
97	Inswing - 4 Horizontal TDs: SN 4023 / Arg / Clr - 27mm(6mm-5mm)											
	0.230	0.630	0.185					ARG90	0.026(#2)	CL	A1-D	T
	U-Factor 0.44			SHGC (>1) 0.13				VT (>1) 0.21		CR 48		
98	Inswing - 4 Horizontal TDs: SN 5128 / Arg / Clr - 27mm(6mm-5mm)											
	0.230	0.630	0.185					ARG90	0.025(#2)	CL	A1-D	T
	U-Factor 0.44			SHGC (>1) 0.15				VT (>1) 0.26		CR 48		
99	Inswing - 4 Horizontal TDs: SN 6234 / Arg / Clr - 27mm(6mm-5mm)											
	0.230	0.630	0.185					ARG90	0.026(#2)	CL	A1-D	T
	U-Factor 0.44			SHGC (>1) 0.17				VT (>1) 0.33		CR 48		
100	Inswing - 4 Horizontal TDs: SN 7037 / Arg / Clr - 27mm(6mm-5mm)											
	0.230	0.630	0.185					ARG90	0.022(#2)	CL	A1-D	T
	U-Factor 0.44			SHGC (>1) 0.19				VT (>1) 0.36		CR 48		

TEST REPORT FOR NEON ENERGY USA INC.

Report No: K0461.02-301-45 R3

Date: 12/18/20

SECTION 6 (Continued)

SIMULATION RESULTS

TOTAL PRODUCT CALCULATIONS (Ultra Outswing and Inswing Door)												
Option Number	Pane Thickness 1 (in)	Gap Width 1 (in)	Pane Thickness 2 (in)	Gap Width 2 (in)	Pane Thickness 3 (in)	Gap Width 3 (in)	Pane Thickness 4 (in)	Gap Fill	Low-e (Surface #)	Tint	Spacer	Grid Type
	U-Factor (Btu/Hr-Ft2-F)			Solar Heat Gain Coefficient (SHGC) Grids (None / <1 / >=1)				Visible Transmittance (VT) Grids (None / <1 / >=1)		Condensation Resistance (CR)		
101	Inswing - 4 Horizontal TDs: ClimaGuard Neutral 70 / Arg / Clr - 27mm(6mm-5mm)											
	0.226	0.630	0.185					ARG90	0.171(#2)	CL	A1-D	T
	U-Factor 0.46			SHGC (>1) 0.30				VT (>1) 0.36		CR 48		
102	Inswing - 4 Horizontal TDs: SNX 6227 / Arg / Clr - 24mm(4mm-4mm)											
	0.151	0.630	0.154					ARG90	0.020(#2)	CL	A1-D	T
	U-Factor 0.43			SHGC (>1) 0.15				VT (>1) 0.33		CR 48		
103	Inswing - 4 Horizontal TDs: ClimaGuard Premium T / Arg / Clr - 24mm(4mm-4mm)											
	0.151	0.630	0.154					ARG90	0.035(#2)	CL	A1-D	T
	U-Factor 0.44			SHGC (>1) 0.28				VT (>1) 0.40		CR 48		
104	Inswing - 4 Horizontal TDs: SN 4023 / Arg / Clr - 24mm(4mm-4mm)											
	0.151	0.630	0.154					ARG90	0.026(#2)	CL	A1-D	T
	U-Factor 0.43			SHGC (>1) 0.13				VT (>1) 0.21		CR 48		
105	Inswing - 4 Horizontal TDs: SN 5128 / Arg / Clr - 24mm(4mm-4mm)											
	0.151	0.630	0.154					ARG90	0.025(#2)	CL	A1-D	T
	U-Factor 0.43			SHGC (>1) 0.15				VT (>1) 0.27		CR 48		
106	Inswing - 4 Horizontal TDs: SN 6234 / Arg / Clr - 24mm(4mm-4mm)											
	0.151	0.630	0.154					ARG90	0.026(#2)	CL	A1-D	T
	U-Factor 0.43			SHGC (>1) 0.17				VT (>1) 0.33		CR 48		
107	Inswing - 4 Horizontal TDs: SN 7037 / Arg / Clr - 24mm(4mm-4mm)											
	0.151	0.630	0.154					ARG90	0.022(#2)	CL	A1-D	T
	U-Factor 0.43			SHGC (>1) 0.19				VT (>1) 0.37		CR 48		
108	Inswing - 4 Horizontal TDs: ClimaGuard Neutral 70 / Arg / Clr - 24mm(4mm-4mm)											
	0.148	0.630	0.154					ARG90	0.171(#2)	CL	A1-D	T
	U-Factor 0.46			SHGC (>1) 0.30				VT (>1) 0.36		CR 48		
109	Inswing - 4 Horizontal TDs: ClimaGuard Neutral 70 / Arg / Clr - 28mm(6mm-5mm)											
	0.226	0.670	0.185					ARG90	0.171(#2)	CL	A1-D	T
	U-Factor 0.47			SHGC (>1) 0.30				VT (>1) 0.36		CR 47		
110	Inswing - 4 Horizontal TDs: ClimaGuard Neutral 70 / Arg / Clr - 28mm(4mm-4mm)											
	0.226	0.787	0.185					ARG90	0.171(#2)	CL	A1-D	T
	U-Factor 0.48			SHGC (>1) 0.30				VT (>1) 0.36		CR 46		

TEST REPORT FOR NEON ENERGY USA INC.

Report No: K0461.02-301-45 R3

Date: 12/18/20

SECTION 6 (Continued)

SIMULATION RESULTS

TOTAL PRODUCT CALCULATIONS (Ultra Outswing and Inswing Door)												
Option Number	Pane Thickness 1 (in)	Gap Width 1 (in)	Pane Thickness 2 (in)	Gap Width 2 (in)	Pane Thickness 3 (in)	Gap Width 3 (in)	Pane Thickness 4 (in)	Gap Fill	Low-e (Surface #)	Tint	Spacer	Grid Type
	U-Factor (Btu/Hr-Ft ² -F)			Solar Heat Gain Coefficient (SHGC) Grids (None / <1 / >=1)				Visible Transmittance (VT) Grids (None / <1 / >=1)		Condensation Resistance (CR)		
111	Inswing - 4 Horizontal TDs: SNX 5123 / Arg / 3mmClr-030PVB-3mmIS20 - 28mm (6mm-6mm)											
	0.221	0.625	0.264					ARG90	0.021(#2) / 0.198(#4)	CL	TS-D	T
	U-Factor 0.37			SHGC (>1) 0.13				VT (>1) 0.26		CR 50		
112	Inswing - 1 Vertical TD: SNX 5123 / Arg / Clr - 28mm(6mm-6mm)											
	0.221	0.630	0.224					ARG90	0.021(#2)	CL	A1-D	T
	U-Factor 0.42			SHGC (>1) 0.13				VT (>1) 0.27		CR 48		
113	Inswing - 1 Vertical TD: SNX 6227 / Arg / Clr - 28mm(6mm-6mm)											
	0.221	0.630	0.224					ARG90	0.020(#2)	CL	A1-D	T
	U-Factor 0.42			SHGC (>1) 0.15				VT (>1) 0.32		CR 48		
114	Inswing - 1 Vertical TD: ClimaGuard Premium T / Arg / Clr - 27mm(6mm-5mm)											
	0.230	0.630	0.185					ARG90	0.035(#2)	CL	A1-D	T
	U-Factor 0.42			SHGC (>1) 0.28				VT (>1) 0.40		CR 48		
115	Inswing - 1 Vertical TD: SN 4023 / Arg / Clr - 27mm(6mm-5mm)											
	0.230	0.630	0.185					ARG90	0.026(#2)	CL	A1-D	T
	U-Factor 0.42			SHGC (>1) 0.13				VT (>1) 0.21		CR 48		
116	Inswing - 1 Vertical TD: SN 5128 / Arg / Clr - 27mm(6mm-5mm)											
	0.230	0.630	0.185					ARG90	0.025(#2)	CL	A1-D	T
	U-Factor 0.42			SHGC (>1) 0.15				VT (>1) 0.26		CR 48		
117	Inswing - 1 Vertical TD: SN 6234 / Arg / Clr - 27mm(6mm-5mm)											
	0.230	0.630	0.185					ARG90	0.026(#2)	CL	A1-D	T
	U-Factor 0.42			SHGC (>1) 0.17				VT (>1) 0.33		CR 48		
118	Inswing - 1 Vertical TD: SN 7037 / Arg / Clr - 27mm(6mm-5mm)											
	0.230	0.630	0.185					ARG90	0.022(#2)	CL	A1-D	T
	U-Factor 0.42			SHGC (>1) 0.19				VT (>1) 0.36		CR 48		
119	Inswing - 1 Vertical TD: ClimaGuard Neutral 70 / Arg / Clr - 27mm(6mm-5mm)											
	0.226	0.630	0.185					ARG90	0.171(#2)	CL	A1-D	T
	U-Factor 0.45			SHGC (>1) 0.30				VT (>1) 0.36		CR 48		
120	Inswing - 1 Vertical TD: SNX 6227 / Arg / Clr - 24mm(4mm-4mm)											
	0.151	0.630	0.154					ARG90	0.020(#2)	CL	A1-D	T
	U-Factor 0.41			SHGC (>1) 0.15				VT (>1) 0.33		CR 48		

TEST REPORT FOR NEON ENERGY USA INC.

Report No: K0461.02-301-45 R3

Date: 12/18/20

SECTION 6 (Continued)

SIMULATION RESULTS

TOTAL PRODUCT CALCULATIONS (Ultra Outswing and Inswing Door)												
Option Number	Pane Thickness 1 (in)	Gap Width 1 (in)	Pane Thickness 2 (in)	Gap Width 2 (in)	Pane Thickness 3 (in)	Gap Width 3 (in)	Pane Thickness 4 (in)	Gap Fill	Low-e (Surface #)	Tint	Spacer	Grid Type
	U-Factor (Btu/Hr-Ft ² -F)			Solar Heat Gain Coefficient (SHGC) Grids (None / <1 / >=1)				Visible Transmittance (VT) Grids (None / <1 / >=1)		Condensation Resistance (CR)		
121	Inswing - 1 Vertical TDL: ClimaGuard Premium T / Arg / Clr - 24mm(4mm-4mm)											
	0.151	0.630	0.154					ARG90	0.035(#2)	CL	A1-D	T
	U-Factor 0.42			SHGC (>1) 0.28				VT (>1) 0.40		CR 48		
122	Inswing - 1 Vertical TDL: SN 4023 / Arg / Clr - 24mm(4mm-4mm)											
	0.151	0.630	0.154					ARG90	0.026(#2)	CL	A1-D	T
	U-Factor 0.42			SHGC (>1) 0.13				VT (>1) 0.21		CR 48		
123	Inswing - 1 Vertical TDL: SN 5128 / Arg / Clr - 24mm(4mm-4mm)											
	0.151	0.630	0.154					ARG90	0.025(#2)	CL	A1-D	T
	U-Factor 0.42			SHGC (>1) 0.15				VT (>1) 0.27		CR 48		
124	Inswing - 1 Vertical TDL: SN 6234 / Arg / Clr - 24mm(4mm-4mm)											
	0.151	0.630	0.154					ARG90	0.026(#2)	CL	A1-D	T
	U-Factor 0.42			SHGC (>1) 0.17				VT (>1) 0.33		CR 48		
125	Inswing - 1 Vertical TDL: SN 7037 / Arg / Clr - 24mm(4mm-4mm)											
	0.151	0.630	0.154					ARG90	0.022(#2)	CL	A1-D	T
	U-Factor 0.41			SHGC (>1) 0.19				VT (>1) 0.37		CR 48		
126	Inswing - 1 Vertical TDL: ClimaGuard Neutral 70 / Arg / Clr - 24mm(4mm-4mm)											
	0.148	0.630	0.154					ARG90	0.171(#2)	CL	A1-D	T
	U-Factor 0.44			SHGC (>1) 0.30				VT (>1) 0.36		CR 48		
127	Inswing - 1 Vertical TDL: ClimaGuard Neutral 70 / Arg / Clr - 28mm(6mm-5mm)											
	0.226	0.670	0.185					ARG90	0.171(#2)	CL	A1-D	T
	U-Factor 0.45			SHGC (>1) 0.30				VT (>1) 0.36		CR 47		
128	Inswing - 1 Vertical TDL: ClimaGuard Neutral 70 / Arg / Clr - 28mm(4mm-4mm)											
	0.226	0.787	0.185					ARG90	0.171(#2)	CL	A1-D	T
	U-Factor 0.46			SHGC (>1) 0.30				VT (>1) 0.36		CR 46		
129	Inswing - 1 Vertical TDL: SNX 5123 / Arg / 3mmClr-030PVB-3mmIS20 - 28mm (6mm-6mm)											
	0.221	0.625	0.264					ARG90	0.021(#2) / 0.198(#4)	CL	TS-D	T
	U-Factor 0.35			SHGC (>1) 0.13				VT (>1) 0.26		CR 50		
130	Inswing - 2 Vertical TDLS: SNX 5123 / Arg / Clr - 28mm(6mm-6mm)											
	0.221	0.630	0.224					ARG90	0.021(#2)	CL	A1-D	T
	U-Factor 0.46			SHGC (>1) 0.13				VT (>1) 0.27		CR 48		

TEST REPORT FOR NEON ENERGY USA INC.

Report No: K0461.02-301-45 R3

Date: 12/18/20

SECTION 6 (Continued)

SIMULATION RESULTS

TOTAL PRODUCT CALCULATIONS (Ultra Outswing and Inswing Door)												
Option Number	Pane Thickness 1 (in)	Gap Width 1 (in)	Pane Thickness 2 (in)	Gap Width 2 (in)	Pane Thickness 3 (in)	Gap Width 3 (in)	Pane Thickness 4 (in)	Gap Fill	Low-e (Surface #)	Tint	Spacer	Grid Type
	U-Factor (Btu/Hr-Ft2-F)			Solar Heat Gain Coefficient (SHGC) Grids (None / <1 / >=1)				Visible Transmittance (VT) Grids (None / <1 / >=1)		Condensation Resistance (CR)		
131	Inswing - 2 Vertical TDs: SNX 6227 / Arg / Clr - 28mm(6mm-6mm)											
	0.221	0.630	0.224					ARG90	0.020(#2)	CL	A1-D	T
	U-Factor 0.46			SHGC (>1) 0.15				VT (>1) 0.32		CR 48		
132	Inswing - 2 Vertical TDs: ClimaGuard Premium T / Arg / Clr - 27mm(6mm-5mm)											
	0.230	0.630	0.185					ARG90	0.035(#2)	CL	A1-D	T
	U-Factor 0.46			SHGC (>1) 0.28				VT (>1) 0.40		CR 48		
133	Inswing - 2 Vertical TDs: SN 4023 / Arg / Clr - 27mm(6mm-5mm)											
	0.230	0.630	0.185					ARG90	0.026(#2)	CL	A1-D	T
	U-Factor 0.46			SHGC (>1) 0.13				VT (>1) 0.21		CR 48		
134	Inswing - 2 Vertical TDs: SN 5128 / Arg / Clr - 27mm(6mm-5mm)											
	0.230	0.630	0.185					ARG90	0.025(#2)	CL	A1-D	T
	U-Factor 0.46			SHGC (>1) 0.15				VT (>1) 0.26		CR 48		
135	Inswing - 2 Vertical TDs: SN 6234 / Arg / Clr - 27mm(6mm-5mm)											
	0.230	0.630	0.185					ARG90	0.026(#2)	CL	A1-D	T
	U-Factor 0.46			SHGC (>1) 0.17				VT (>1) 0.33		CR 48		
136	Inswing - 2 Vertical TDs: SN 7037 / Arg / Clr - 27mm(6mm-5mm)											
	0.230	0.630	0.185					ARG90	0.022(#2)	CL	A1-D	T
	U-Factor 0.46			SHGC (>1) 0.19				VT (>1) 0.36		CR 48		
137	Inswing - 2 Vertical TDs: ClimaGuard Neutral 70 / Arg / Clr - 27mm(6mm-5mm)											
	0.226	0.630	0.185					ARG90	0.171(#2)	CL	A1-D	T
	U-Factor 0.48			SHGC (>1) 0.30				VT (>1) 0.36		CR 48		
138	Inswing - 2 Vertical TDs: SNX 6227 / Arg / Clr - 24mm(4mm-4mm)											
	0.151	0.630	0.154					ARG90	0.020(#2)	CL	A1-D	T
	U-Factor 0.45			SHGC (>1) 0.15				VT (>1) 0.33		CR 48		
139	Inswing - 2 Vertical TDs: ClimaGuard Premium T / Arg / Clr - 24mm(4mm-4mm)											
	0.151	0.630	0.154					ARG90	0.035(#2)	CL	A1-D	T
	U-Factor 0.45			SHGC (>1) 0.28				VT (>1) 0.40		CR 48		
140	Inswing - 2 Vertical TDs: SN 4023 / Arg / Clr - 24mm(4mm-4mm)											
	0.151	0.630	0.154					ARG90	0.026(#2)	CL	A1-D	T
	U-Factor 0.45			SHGC (>1) 0.13				VT (>1) 0.21		CR 48		

TEST REPORT FOR NEON ENERGY USA INC.

Report No: K0461.02-301-45 R3

Date: 12/18/20

SECTION 6 (Continued)

SIMULATION RESULTS

TOTAL PRODUCT CALCULATIONS (Ultra Outswing and Inswing Door)												
Option Number	Pane Thickness 1 (in)	Gap Width 1 (in)	Pane Thickness 2 (in)	Gap Width 2 (in)	Pane Thickness 3 (in)	Gap Width 3 (in)	Pane Thickness 4 (in)	Gap Fill	Low-e (Surface #)	Tint	Spacer	Grid Type
	U-Factor (Btu/Hr-Ft2-F)			Solar Heat Gain Coefficient (SHGC) Grids (None / <1 / >=1)				Visible Transmittance (VT) Grids (None / <1 / >=1)		Condensation Resistance (CR)		
141	Inswing - 2 Vertical TDs: SN 5128 / Arg / Clr - 24mm(4mm-4mm)											
	0.151	0.630	0.154					ARG90	0.025(#2)	CL	A1-D	T
	U-Factor 0.45			SHGC (>1) 0.15				VT (>1) 0.27		CR 48		
142	Inswing - 2 Vertical TDs: SN 6234 / Arg / Clr - 24mm(4mm-4mm)											
	0.151	0.630	0.154					ARG90	0.026(#2)	CL	A1-D	T
	U-Factor 0.45			SHGC (>1) 0.17				VT (>1) 0.33		CR 48		
143	Inswing - 2 Vertical TDs: SN 7037 / Arg / Clr - 24mm(4mm-4mm)											
	0.151	0.630	0.154					ARG90	0.022(#2)	CL	A1-D	T
	U-Factor 0.45			SHGC (>1) 0.19				VT (>1) 0.37		CR 48		
144	Inswing - 2 Vertical TDs: ClimaGuard Neutral 70 / Arg / Clr - 24mm(4mm-4mm)											
	0.148	0.630	0.154					ARG90	0.171(#2)	CL	A1-D	T
	U-Factor 0.48			SHGC (>1) 0.30				VT (>1) 0.36		CR 48		
145	Inswing - 2 Vertical TDs: ClimaGuard Neutral 70 / Arg / Clr - 28mm(6mm-5mm)											
	0.226	0.670	0.185					ARG90	0.171(#2)	CL	A1-D	T
	U-Factor 0.49			SHGC (>1) 0.30				VT (>1) 0.36		CR 47		
146	Inswing - 2 Vertical TDs: ClimaGuard Neutral 70 / Arg / Clr - 28mm(4mm-4mm)											
	0.226	0.787	0.185					ARG90	0.171(#2)	CL	A1-D	T
	U-Factor 0.49			SHGC (>1) 0.30				VT (>1) 0.36		CR 46		
147	Inswing - 2 Vertical TDs: SNX 5123 / Arg / 3mmClr-030PVB-3mmIS20 - 28mm (6mm-6mm)											
	0.221	0.625	0.264					ARG90	0.021(#2) / 0.198(#4)	CL	TS-D	T
	U-Factor 0.38			SHGC (>1) 0.13				VT (>1) 0.26		CR 50		
148	Inswing - 3 Vertical TDs: SNX 5123 / Arg / Clr - 28mm(6mm-6mm)											
	0.221	0.630	0.224					ARG90	0.021(#2)	CL	A1-D	T
	U-Factor 0.50			SHGC (>1) 0.13				VT (>1) 0.27		CR 48		
149	Inswing - 3 Vertical TDs: SNX 6227 / Arg / Clr - 28mm(6mm-6mm)											
	0.221	0.630	0.224					ARG90	0.020(#2)	CL	A1-D	T
	U-Factor 0.50			SHGC (>1) 0.15				VT (>1) 0.32		CR 48		
150	Inswing - 3 Vertical TDs: ClimaGuard Premium T / Arg / Clr - 27mm(6mm-5mm)											
	0.230	0.630	0.185					ARG90	0.035(#2)	CL	A1-D	T
	U-Factor 0.50			SHGC (>1) 0.28				VT (>1) 0.40		CR 48		

TEST REPORT FOR NEON ENERGY USA INC.

Report No: K0461.02-301-45 R3

Date: 12/18/20

SECTION 6 (Continued)

SIMULATION RESULTS

TOTAL PRODUCT CALCULATIONS (Ultra Outswing and Inswing Door)												
Option Number	Pane Thickness 1 (in)	Gap Width 1 (in)	Pane Thickness 2 (in)	Gap Width 2 (in)	Pane Thickness 3 (in)	Gap Width 3 (in)	Pane Thickness 4 (in)	Gap Fill	Low-e (Surface #)	Tint	Spacer	Grid Type
	U-Factor (Btu/Hr-Ft2-F)			Solar Heat Gain Coefficient (SHGC) Grids (None / <1 / >=1)				Visible Transmittance (VT) Grids (None / <1 / >=1)		Condensation Resistance (CR)		
151	Inswing - 3 Vertical TDs: SN 4023 / Arg / Clr - 27mm(6mm-5mm)											
	0.230	0.630	0.185					ARG90	0.026(#2)	CL	A1-D	T
	U-Factor 0.50			SHGC (>1) 0.13				VT (>1) 0.21		CR 48		
152	Inswing - 3 Vertical TDs: SN 5128 / Arg / Clr - 27mm(6mm-5mm)											
	0.230	0.630	0.185					ARG90	0.025(#2)	CL	A1-D	T
	U-Factor 0.50			SHGC (>1) 0.15				VT (>1) 0.26		CR 48		
153	Inswing - 3 Vertical TDs: SN 6234 / Arg / Clr - 27mm(6mm-5mm)											
	0.230	0.630	0.185					ARG90	0.026(#2)	CL	A1-D	T
	U-Factor 0.50			SHGC (>1) 0.17				VT (>1) 0.33		CR 48		
154	Inswing - 3 Vertical TDs: SN 7037 / Arg / Clr - 27mm(6mm-5mm)											
	0.230	0.630	0.185					ARG90	0.022(#2)	CL	A1-D	T
	U-Factor 0.50			SHGC (>1) 0.19				VT (>1) 0.36		CR 48		
155	Inswing - 3 Vertical TDs: ClimaGuard Neutral 70 / Arg / Clr - 27mm(6mm-5mm)											
	0.226	0.630	0.185					ARG90	0.171(#2)	CL	A1-D	T
	U-Factor 0.52			SHGC (>1) 0.30				VT (>1) 0.36		CR 48		
156	Inswing - 3 Vertical TDs: SNX 6227 / Arg / Clr - 24mm(4mm-4mm)											
	0.151	0.630	0.154					ARG90	0.020(#2)	CL	A1-D	T
	U-Factor 0.49			SHGC (>1) 0.15				VT (>1) 0.33		CR 48		
157	Inswing - 3 Vertical TDs: ClimaGuard Premium T / Arg / Clr - 24mm(4mm-4mm)											
	0.151	0.630	0.154					ARG90	0.035(#2)	CL	A1-D	T
	U-Factor 0.49			SHGC (>1) 0.28				VT (>1) 0.40		CR 48		
158	Inswing - 3 Vertical TDs: SN 4023 / Arg / Clr - 24mm(4mm-4mm)											
	0.151	0.630	0.154					ARG90	0.026(#2)	CL	A1-D	T
	U-Factor 0.49			SHGC (>1) 0.13				VT (>1) 0.21		CR 48		
159	Inswing - 3 Vertical TDs: SN 5128 / Arg / Clr - 24mm(4mm-4mm)											
	0.151	0.630	0.154					ARG90	0.025(#2)	CL	A1-D	T
	U-Factor 0.49			SHGC (>1) 0.15				VT (>1) 0.27		CR 48		
160	Inswing - 3 Vertical TDs: SN 6234 / Arg / Clr - 24mm(4mm-4mm)											
	0.151	0.630	0.154					ARG90	0.026(#2)	CL	A1-D	T
	U-Factor 0.49			SHGC (>1) 0.17				VT (>1) 0.33		CR 48		

TEST REPORT FOR NEON ENERGY USA INC.

Report No: K0461.02-301-45 R3

Date: 12/18/20

SECTION 6 (Continued)

SIMULATION RESULTS

TOTAL PRODUCT CALCULATIONS (Ultra Outswing and Inswing Door)												
Option Number	Pane Thickness 1 (in)	Gap Width 1 (in)	Pane Thickness 2 (in)	Gap Width 2 (in)	Pane Thickness 3 (in)	Gap Width 3 (in)	Pane Thickness 4 (in)	Gap Fill	Low-e (Surface #)	Tint	Spacer	Grid Type
	U-Factor (Btu/Hr-Ft2-F)			Solar Heat Gain Coefficient (SHGC) Grids (None / <1 / >=1)				Visible Transmittance (VT) Grids (None / <1 / >=1)		Condensation Resistance (CR)		
161	Inswing - 3 Vertical TDs: SN 7037 / Arg / Clr - 24mm(4mm-4mm)											
	0.151	0.630	0.154					ARG90	0.022(#2)	CL	A1-D	T
	U-Factor 0.49			SHGC (>1) 0.19				VT (>1) 0.37		CR 48		
162	Inswing - 3 Vertical TDs: ClimaGuard Neutral 70 / Arg / Clr - 24mm(4mm-4mm)											
	0.148	0.630	0.154					ARG90	0.171(#2)	CL	A1-D	T
	U-Factor 0.51			SHGC (>1) 0.30				VT (>1) 0.36		CR 48		
163	Inswing - 3 Vertical TDs: ClimaGuard Neutral 70 / Arg / Clr - 28mm(6mm-5mm)											
	0.226	0.670	0.185					ARG90	0.171(#2)	CL	A1-D	T
	U-Factor 0.52			SHGC (>1) 0.30				VT (>1) 0.36		CR 47		
164	Inswing - 3 Vertical TDs: ClimaGuard Neutral 70 / Arg / Clr - 28mm(4mm-4mm)											
	0.226	0.787	0.185					ARG90	0.171(#2)	CL	A1-D	T
	U-Factor 0.53			SHGC (>1) 0.30				VT (>1) 0.36		CR 46		
165	Inswing - 3 Vertical TDs: SNX 5123 / Arg / 3mmClr-030PVB-3mmIS20 - 28mm (6mm-6mm)											
	0.221	0.625	0.264					ARG90	0.021(#2) / 0.198(#4)	CL	TS-D	T
	U-Factor 0.41			SHGC (>1) 0.13				VT (>1) 0.26		CR 50		
166	Inswing - 4 Vertical TDs: SNX 5123 / Arg / Clr - 28mm(6mm-6mm)											
	0.221	0.630	0.224					ARG90	0.021(#2)	CL	A1-D	T
	U-Factor 0.57			SHGC (>1) 0.13				VT (>1) 0.27		CR 48		
167	Inswing - 4 Vertical TDs: SNX 6227 / Arg / Clr - 28mm(6mm-6mm)											
	0.221	0.630	0.224					ARG90	0.020(#2)	CL	A1-D	T
	U-Factor 0.57			SHGC (>1) 0.15				VT (>1) 0.32		CR 48		
168	Inswing - 4 Vertical TDs: ClimaGuard Premium T / Arg / Clr - 27mm(6mm-5mm)											
	0.230	0.630	0.185					ARG90	0.035(#2)	CL	A1-D	T
	U-Factor 0.57			SHGC (>1) 0.28				VT (>1) 0.40		CR 48		
169	Inswing - 4 Vertical TDs: SN 4023 / Arg / Clr - 27mm(6mm-5mm)											
	0.230	0.630	0.185					ARG90	0.026(#2)	CL	A1-D	T
	U-Factor 0.57			SHGC (>1) 0.13				VT (>1) 0.21		CR 48		
170	Inswing - 4 Vertical TDs: SN 5128 / Arg / Clr - 27mm(6mm-5mm)											
	0.230	0.630	0.185					ARG90	0.025(#2)	CL	A1-D	T
	U-Factor 0.57			SHGC (>1) 0.15				VT (>1) 0.26		CR 48		

TEST REPORT FOR NEON ENERGY USA INC.

Report No: K0461.02-301-45 R3

Date: 12/18/20

SECTION 6 (Continued) SIMULATION RESULTS

TOTAL PRODUCT CALCULATIONS (Ultra Outswing and Inswing Door)												
Option Number	Pane Thickness 1 (in)	Gap Width 1 (in)	Pane Thickness 2 (in)	Gap Width 2 (in)	Pane Thickness 3 (in)	Gap Width 3 (in)	Pane Thickness 4 (in)	Gap Fill	Low-e (Surface #)	Tint	Spacer	Grid Type
	U-Factor (Btu/Hr-Ft2-F)			Solar Heat Gain Coefficient (SHGC) Grids (None / <1 / >=1)				Visible Transmittance (VT) Grids (None / <1 / >=1)		Condensation Resistance (CR)		
171	Inswing - 4 Vertical TDs: SN 6234 / Arg / Clr - 27mm(6mm-5mm)											
	0.230	0.630	0.185					ARG90	0.026(#2)	CL	A1-D	T
	U-Factor 0.57			SHGC (>1) 0.17				VT (>1) 0.33		CR 48		
172	Inswing - 4 Vertical TDs: SN 7037 / Arg / Clr - 27mm(6mm-5mm)											
	0.230	0.630	0.185					ARG90	0.022(#2)	CL	A1-D	T
	U-Factor 0.57			SHGC (>1) 0.19				VT (>1) 0.36		CR 48		
173	Inswing - 4 Vertical TDs: ClimaGuard Neutral 70 / Arg / Clr - 27mm(6mm-5mm)											
	0.226	0.630	0.185					ARG90	0.171(#2)	CL	A1-D	T
	U-Factor 0.59			SHGC (>1) 0.30				VT (>1) 0.36		CR 47		
174	Inswing - 4 Vertical TDs: SNX 6227 / Arg / Clr - 24mm(4mm-4mm)											
	0.151	0.630	0.154					ARG90	0.020(#2)	CL	A1-D	T
	U-Factor 0.56			SHGC (>1) 0.15				VT (>1) 0.33		CR 48		
175	Inswing - 4 Vertical TDs: ClimaGuard Premium T / Arg / Clr - 24mm(4mm-4mm)											
	0.151	0.630	0.154					ARG90	0.035(#2)	CL	A1-D	T
	U-Factor 0.56			SHGC (>1) 0.28				VT (>1) 0.40		CR 48		
176	Inswing - 4 Vertical TDs: SN 4023 / Arg / Clr - 24mm(4mm-4mm)											
	0.151	0.630	0.154					ARG90	0.026(#2)	CL	A1-D	T
	U-Factor 0.56			SHGC (>1) 0.13				VT (>1) 0.21		CR 48		
177	Inswing - 4 Vertical TDs: SN 5128 / Arg / Clr - 24mm(4mm-4mm)											
	0.151	0.630	0.154					ARG90	0.025(#2)	CL	A1-D	T
	U-Factor 0.56			SHGC (>1) 0.15				VT (>1) 0.27		CR 48		
178	Inswing - 4 Vertical TDs: SN 6234 / Arg / Clr - 24mm(4mm-4mm)											
	0.151	0.630	0.154					ARG90	0.026(#2)	CL	A1-D	T
	U-Factor 0.56			SHGC (>1) 0.17				VT (>1) 0.33		CR 48		
179	Inswing - 4 Vertical TDs: SN 7037 / Arg / Clr - 24mm(4mm-4mm)											
	0.151	0.630	0.154					ARG90	0.022(#2)	CL	A1-D	T
	U-Factor 0.56			SHGC (>1) 0.19				VT (>1) 0.37		CR 48		
180	Inswing - 4 Vertical TDs: ClimaGuard Neutral 70 / Arg / Clr - 24mm(4mm-4mm)											
	0.148	0.630	0.154					ARG90	0.171(#2)	CL	A1-D	T
	U-Factor 0.58			SHGC (>1) 0.30				VT (>1) 0.36		CR 48		

TEST REPORT FOR NEON ENERGY USA INC.

Report No: K0461.02-301-45 R3

Date: 12/18/20

SECTION 6 (Continued)

SIMULATION RESULTS

TOTAL PRODUCT CALCULATIONS (Ultra Outswing and Inswing Door)												
Option Number	Pane Thickness 1 (in)	Gap Width 1 (in)	Pane Thickness 2 (in)	Gap Width 2 (in)	Pane Thickness 3 (in)	Gap Width 3 (in)	Pane Thickness 4 (in)	Gap Fill	Low-e (Surface #)	Tint	Spacer	Grid Type
	U-Factor (Btu/Hr-Ft ² -F)			Solar Heat Gain Coefficient (SHGC) Grids (None / <1 / >=1)				Visible Transmittance (VT) Grids (None / <1 / >=1)		Condensation Resistance (CR)		
181	Inswing - 4 Vertical TDs: ClimaGuard Neutral 70 / Arg / Clr - 28mm(6mm-5mm)											
	0.226	0.670	0.185					ARG90	0.171(#2)	CL	A1-D	T
	U-Factor 0.59			SHGC (>1) 0.30				VT (>1) 0.36		CR 47		
182	Inswing - 4 Vertical TDs: ClimaGuard Neutral 70 / Arg / Clr - 28mm(4mm-4mm)											
	0.226	0.787	0.185					ARG90	0.171(#2)	CL	A1-D	T
	U-Factor 0.61			SHGC (>1) 0.30				VT (>1) 0.36		CR 45		
183	Inswing - 4 Vertical TDs: SNX 5123 / Arg / 3mmClr-030PVB-3mmIS20 - 28mm (6mm-6mm)											
	0.221	0.625	0.264					ARG90	0.021(#2) / 0.198(#4)	CL	TS-D	T
	U-Factor 0.46			SHGC (>1) 0.13				VT (>1) 0.26		CR 50		
184	Inswing: SN 5128 / Arg / Climaguard Dry - 27mm(6mm-6mm)											
	0.230	0.590	0.230					ARG90	0.025(#2) / 0.200(#4)	CL	TP-D	N
	U-Factor 0.32			SHGC (N) 0.18				VT (N) 0.35		CR 51		
185	Inswing - SN 5128 / Arg / ClimaGurad Dry - 27mm(6mm-6mm): SN 5128 / Arg / Climaguard Dry - 27mm(6mm-6mm)											
	0.230	0.590	0.230					ARG90	0.025(#2) / 0.200(#4)	CL	TP-D	T
	U-Factor 0.43			SHGC (>1) 0.14				VT (>1) 0.26		CR 51		
186	Inswing - 1 Horizontal TD: SN 5128 / Arg / Climaguard Dry - 27mm(6mm-6mm)											
	0.230	0.590	0.230					ARG90	0.025(#2) / 0.200(#4)	CL	TP-D	T
	U-Factor 0.33			SHGC (>1) 0.14				VT (>1) 0.26		CR 51		
187	Inswing - 2 Horizontal TDs: SN 5128 / Arg / Climaguard Dry - 27mm(6mm-6mm)											
	0.230	0.590	0.230					ARG90	0.025(#2) / 0.200(#4)	CL	TP-D	T
	U-Factor 0.34			SHGC (>1) 0.14				VT (>1) 0.26		CR 51		
188	Inswing - 3 Horizontal TDs: SN 5128 / Arg / Climaguard Dry - 27mm(6mm-6mm)											
	0.230	0.590	0.230					ARG90	0.025(#2) / 0.200(#4)	CL	TP-D	T
	U-Factor 0.35			SHGC (>1) 0.14				VT (>1) 0.26		CR 51		
189	Inswing - 4 Horizontal TDs: SN 5128 / Arg / Climaguard Dry - 27mm(6mm-6mm)											
	0.230	0.590	0.230					ARG90	0.025(#2) / 0.200(#4)	CL	TP-D	T
	U-Factor 0.36			SHGC (>1) 0.14				VT (>1) 0.26		CR 51		
190	Inswing - 1 Vertical TD: SN 5128 / Arg / Climaguard Dry - 27mm(6mm-6mm)											
	0.230	0.590	0.230					ARG90	0.025(#2) / 0.200(#4)	CL	TP-D	T
	U-Factor 0.35			SHGC (>1) 0.14				VT (>1) 0.26		CR 51		

TEST REPORT FOR NEON ENERGY USA INC.

Report No: K0461.02-301-45 R3

Date: 12/18/20

SECTION 6 (Continued)

SIMULATION RESULTS

TOTAL PRODUCT CALCULATIONS (Ultra Outswing and Inswing Door)												
Option Number	Pane Thickness 1 (in)	Gap Width 1 (in)	Pane Thickness 2 (in)	Gap Width 2 (in)	Pane Thickness 3 (in)	Gap Width 3 (in)	Pane Thickness 4 (in)	Gap Fill	Low-e (Surface #)	Tint	Spacer	Grid Type
	U-Factor (Btu/Hr-Ft ² -F)			Solar Heat Gain Coefficient (SHGC) Grids (None / <1 / >=1)				Visible Transmittance (VT) Grids (None / <1 / >=1)		Condensation Resistance (CR)		
191	Inswing - 2 Vertical TDs: SN 5128 / Arg / Climaguard Dry - 27mm(6mm-6mm)											
	0.230	0.590	0.230					ARG90	0.025(#2) / 0.200(#4)	CL	TP-D	T
	U-Factor 0.37			SHGC (>1) 0.14				VT (>1) 0.26		CR 51		
192	Inswing - 3 Vertical TDs: SN 5128 / Arg / Climaguard Dry - 27mm(6mm-6mm)											
	0.230	0.590	0.230					ARG90	0.025(#2) / 0.200(#4)	CL	TP-D	T
	U-Factor 0.39			SHGC (>1) 0.14				VT (>1) 0.26		CR 51		
193	Inswing - 4 Vertical TDs: SN 5128 / Arg / Climaguard Dry - 27mm(6mm-6mm)											
	0.230	0.590	0.230					ARG90	0.025(#2) / 0.200(#4)	CL	TP-D	T
	U-Factor 0.44			SHGC (>1) 0.14				VT (>1) 0.26		CR 51		
194	Inswing: SN 5128 / Arg / IS20 - 27mm(6mm-6mm)											
	0.230	0.590	0.221					ARG90	0.025(#2) / 0.198(#4)	CL	TP-D	N
	U-Factor 0.32			SHGC (N) 0.18				VT (N) 0.34		CR 51		
195	Inswing - SN 5128 / Arg / IS20 - 27mm(6mm-6mm): SN 5128 / Arg / IS20 - 27mm(6mm-6mm)											
	0.230	0.590	0.221					ARG90	0.025(#2) / 0.198(#4)	CL	TP-D	T
	U-Factor 0.43			SHGC (>1) 0.14				VT (>1) 0.26		CR 51		
196	Inswing - 1 Horizontal TD: SN 5128 / Arg / IS20 - 27mm(6mm-6mm)											
	0.230	0.590	0.221					ARG90	0.025(#2) / 0.198(#4)	CL	TP-D	T
	U-Factor 0.33			SHGC (>1) 0.14				VT (>1) 0.26		CR 51		
197	Inswing - 2 Horizontal TDs: SN 5128 / Arg / IS20 - 27mm(6mm-6mm)											
	0.230	0.590	0.221					ARG90	0.025(#2) / 0.198(#4)	CL	TP-D	T
	U-Factor 0.34			SHGC (>1) 0.14				VT (>1) 0.26		CR 51		
198	Inswing - 3 Horizontal TDs: SN 5128 / Arg / IS20 - 27mm(6mm-6mm)											
	0.230	0.590	0.221					ARG90	0.025(#2) / 0.198(#4)	CL	TP-D	T
	U-Factor 0.35			SHGC (>1) 0.14				VT (>1) 0.26		CR 51		
199	Inswing - 4 Horizontal TDs: SN 5128 / Arg / IS20 - 27mm(6mm-6mm)											
	0.230	0.590	0.221					ARG90	0.025(#2) / 0.198(#4)	CL	TP-D	T
	U-Factor 0.36			SHGC (>1) 0.14				VT (>1) 0.26		CR 51		
200	Inswing - 1 Vertical TD: SN 5128 / Arg / IS20 - 27mm(6mm-6mm)											
	0.230	0.590	0.221					ARG90	0.025(#2) / 0.198(#4)	CL	TP-D	T
	U-Factor 0.35			SHGC (>1) 0.14				VT (>1) 0.26		CR 51		

TEST REPORT FOR NEON ENERGY USA INC.

Report No: K0461.02-301-45 R3

Date: 12/18/20

SECTION 6 (Continued) SIMULATION RESULTS

TOTAL PRODUCT CALCULATIONS (Ultra Outswing and Inswing Door)												
Option Number	Pane Thickness 1 (in)	Gap Width 1 (in)	Pane Thickness 2 (in)	Gap Width 2 (in)	Pane Thickness 3 (in)	Gap Width 3 (in)	Pane Thickness 4 (in)	Gap Fill	Low-e (Surface #)	Tint	Spacer	Grid Type
	U-Factor (Btu/Hr-Ft ² -F)			Solar Heat Gain Coefficient (SHGC) Grids (None / <1 / >=1)				Visible Transmittance (VT) Grids (None / <1 / >=1)		Condensation Resistance (CR)		
201	Inswing - 2 Vertical TDLS: SN 5128 / Arg / IS20 - 27mm(6mm-6mm)											
	0.230	0.590	0.221					ARG90	0.025(#2) / 0.198(#4)	CL	TP-D	T
	U-Factor 0.37			SHGC (>1) 0.14				VT (>1) 0.26		CR 51		
202	Inswing - 3 Vertical TDLS: SN 5128 / Arg / IS20 - 27mm(6mm-6mm)											
	0.230	0.590	0.221					ARG90	0.025(#2) / 0.198(#4)	CL	TP-D	T
	U-Factor 0.39			SHGC (>1) 0.14				VT (>1) 0.26		CR 51		
203	Inswing - 4 Vertical TDLS: SN 5128 / Arg / IS20 - 27mm(6mm-6mm)											
	0.230	0.590	0.221					ARG90	0.025(#2) / 0.198(#4)	CL	TP-D	T
	U-Factor 0.43			SHGC (>1) 0.14				VT (>1) 0.26		CR 51		
204	Inswing: 4mm-076PVB-4mmPlanistar / Arg / 3mmClr-076PVB-3mmClr - 28mm(8mm-6mm)											
	0.384	0.391	0.311					ARG90	0.026(#2)	CL	A1-D	N
	U-Factor 0.37			SHGC (N) 0.24				VT (N) 0.48		CR 48		
205	Inswing - 4mm-076PVB-4mmPlanistar / Arg / 3mmClr-076PVB-3mmClr - 28mm(8mm-6mm); 4mm-076PVB-4mmPlanistar / Arg / 3mmClr-076PVB-3mmClr - 28mm(8mm-6mm)											
	0.384	0.391	0.311					ARG90	0.026(#2)	CL	A1-D	T
	U-Factor 0.52			SHGC (>1) 0.19				VT (>1) 0.36		CR 48		
206	Inswing - 1 Horizontal TDLS: 4mm-076PVB-4mmPlanistar / Arg / 3mmClr-076PVB-3mmClr - 28mm(8mm-6mm)											
	0.384	0.391	0.311					ARG90	0.026(#2)	CL	A1-D	T
	U-Factor 0.38			SHGC (>1) 0.19				VT (>1) 0.36		CR 48		
207	Inswing - 2 Horizontal TDLS: 4mm-076PVB-4mmPlanistar / Arg / 3mmClr-076PVB-3mmClr - 28mm(8mm-6mm)											
	0.384	0.391	0.311					ARG90	0.026(#2)	CL	A1-D	T
	U-Factor 0.39			SHGC (>1) 0.19				VT (>1) 0.36		CR 48		
208	Inswing - 3 Horizontal TDLS: 4mm-076PVB-4mmPlanistar / Arg / 3mmClr-076PVB-3mmClr - 28mm(8mm-6mm)											
	0.384	0.391	0.311					ARG90	0.026(#2)	CL	A1-D	T
	U-Factor 0.41			SHGC (>1) 0.19				VT (>1) 0.36		CR 48		
209	Inswing - 4 Horizontal TDLS: 4mm-076PVB-4mmPlanistar / Arg / 3mmClr-076PVB-3mmClr - 28mm(8mm-6mm)											
	0.384	0.391	0.311					ARG90	0.026(#2)	CL	A1-D	T
	U-Factor 0.42			SHGC (>1) 0.19				VT (>1) 0.36		CR 48		
210	Inswing - 1 Vertical TDLS: 4mm-076PVB-4mmPlanistar / Arg / 3mmClr-076PVB-3mmClr - 28mm(8mm-6mm)											
	0.384	0.391	0.311					ARG90	0.026(#2)	CL	A1-D	T
	U-Factor 0.40			SHGC (>1) 0.19				VT (>1) 0.36		CR 48		

TEST REPORT FOR NEON ENERGY USA INC.

Report No: K0461.02-301-45 R3

Date: 12/18/20

SECTION 6 (Continued) SIMULATION RESULTS

TOTAL PRODUCT CALCULATIONS (Ultra Outswing and Inswing Door)												
Option Number	Pane Thickness 1 (in)	Gap Width 1 (in)	Pane Thickness 2 (in)	Gap Width 2 (in)	Pane Thickness 3 (in)	Gap Width 3 (in)	Pane Thickness 4 (in)	Gap Fill	Low-e (Surface #)	Tint	Spacer	Grid Type
	U-Factor (Btu/Hr-Ft ² -F)			Solar Heat Gain Coefficient (SHGC) Grids (None / <1 / >=1)				Visible Transmittance (VT) Grids (None / <1 / >=1)		Condensation Resistance (CR)		
211	Inswing - 2 Vertical TDLS: 4mm-076PVB-4mmPlanistar / Arg / 3mmClr-076PVB-3mmClr - 28mm(8mm-6mm)											
	0.384	0.391	0.311					ARG90	0.026(#2)	CL	A1-D	T
	U-Factor 0.44			SHGC (>1) 0.19				VT (>1) 0.36		CR 48		
212	Inswing - 3 Vertical TDLS: 4mm-076PVB-4mmPlanistar / Arg / 3mmClr-076PVB-3mmClr - 28mm(8mm-6mm)											
	0.384	0.391	0.311					ARG90	0.026(#2)	CL	A1-D	T
	U-Factor 0.47			SHGC (>1) 0.19				VT (>1) 0.36		CR 48		
213	Inswing - 4 Vertical TDLS: 4mm-076PVB-4mmPlanistar / Arg / 3mmClr-076PVB-3mmClr - 28mm(8mm-6mm)											
	0.384	0.391	0.311					ARG90	0.026(#2)	CL	A1-D	T
	U-Factor 0.53			SHGC (>1) 0.19				VT (>1) 0.36		CR 48		
214	Inswing w/ Kickplate: SNX 5123 / Arg / Clr - 28mm(6mm-6mm)											
	0.221	0.630	0.224					ARG90	0.021(#2)	CL	A1-D	N
	U-Factor 0.41			SHGC (N) 0.16				VT (N) 0.33		CR 46		
215	Inswing w/ Kickplate - NFRC Default: SNX 5123 / Arg / Clr - 28mm(6mm-6mm)											
	0.221	0.630	0.224					ARG90	0.021(#2)	CL	A1-D	T
	U-Factor 0.57			SHGC (>1) 0.12				VT (>1) 0.24		CR 46		
216	Inswing w/ Kickplate: SNX 6227 / Arg / Clr - 28mm(6mm-6mm)											
	0.221	0.630	0.224					ARG90	0.020(#2)	CL	A1-D	N
	U-Factor 0.41			SHGC (N) 0.18				VT (N) 0.40		CR 46		
217	Inswing w/ Kickplate - NFRC Default: SNX 6227 / Arg / Clr - 28mm(6mm-6mm)											
	0.221	0.630	0.224					ARG90	0.020(#2)	CL	A1-D	T
	U-Factor 0.57			SHGC (>1) 0.14				VT (>1) 0.29		CR 46		
218	Inswing w/ Kickplate: ClimaGuard Premium T / Arg / Clr - 27mm(6mm-5mm)											
	0.230	0.630	0.185					ARG90	0.035(#2)	CL	A1-D	N
	U-Factor 0.41			SHGC (N) 0.34				VT (N) 0.49		CR 46		
219	Inswing w/ Kickplate - NFRC Default: ClimaGuard Premium T / Arg / Clr - 27mm(6mm-5mm)											
	0.230	0.630	0.185					ARG90	0.035(#2)	CL	A1-D	T
	U-Factor 0.57			SHGC (>1) 0.26				VT (>1) 0.36		CR 46		
220	Inswing w/ Kickplate: SN 4023 / Arg / Clr - 27mm(6mm-5mm)											
	0.230	0.630	0.185					ARG90	0.026(#2)	CL	A1-D	N
	U-Factor 0.41			SHGC (N) 0.15				VT (N) 0.25		CR 46		

TEST REPORT FOR NEON ENERGY USA INC.

Report No: K0461.02-301-45 R3

Date: 12/18/20

SECTION 6 (Continued)

SIMULATION RESULTS

TOTAL PRODUCT CALCULATIONS (Ultra Outswing and Inswing Door)												
Option Number	Pane Thickness 1 (in)	Gap Width 1 (in)	Pane Thickness 2 (in)	Gap Width 2 (in)	Pane Thickness 3 (in)	Gap Width 3 (in)	Pane Thickness 4 (in)	Gap Fill	Low-e (Surface #)	Tint	Spacer	Grid Type
	U-Factor (Btu/Hr-Ft ² -F)			Solar Heat Gain Coefficient (SHGC) Grids (None / <1 / >=1)				Visible Transmittance (VT) Grids (None / <1 / >=1)		Condensation Resistance (CR)		
221	Inswing w/ Kickplate - NFRC Default: SN 4023 / Arg / Clr - 27mm(6mm-5mm)											
	0.230	0.630	0.185					ARG90	0.026(#2)	CL	A1-D	T
	U-Factor 0.57			SHGC (>1) 0.12				VT (>1) 0.19		CR 46		
222	Inswing w/ Kickplate: SN 5128 / Arg / Clr - 27mm(6mm-5mm)											
	0.230	0.630	0.185					ARG90	0.025(#2)	CL	A1-D	N
	U-Factor 0.41			SHGC (N) 0.18				VT (N) 0.32		CR 46		
223	Inswing w/ Kickplate - NFRC Default: SN 5128 / Arg / Clr - 27mm(6mm-5mm)											
	0.230	0.630	0.185					ARG90	0.025(#2)	CL	A1-D	T
	U-Factor 0.57			SHGC (>1) 0.14				VT (>1) 0.24		CR 46		
224	Inswing w/ Kickplate: SN 6234 / Arg / Clr - 27mm(6mm-5mm)											
	0.230	0.630	0.185					ARG90	0.026(#2)	CL	A1-D	N
	U-Factor 0.41			SHGC (N) 0.21				VT (N) 0.40		CR 46		
225	Inswing w/ Kickplate - NFRC Default: SN 6234 / Arg / Clr - 27mm(6mm-5mm)											
	0.230	0.630	0.185					ARG90	0.026(#2)	CL	A1-D	T
	U-Factor 0.57			SHGC (>1) 0.16				VT (>1) 0.29		CR 46		
226	Inswing w/ Kickplate: SN 7037 / Arg / Clr - 27mm(6mm-5mm)											
	0.230	0.630	0.185					ARG90	0.022(#2)	CL	A1-D	N
	U-Factor 0.41			SHGC (N) 0.23				VT (N) 0.45		CR 46		
227	Inswing w/ Kickplate - NFRC Default: SN 7037 / Arg / Clr - 27mm(6mm-5mm)											
	0.230	0.630	0.185					ARG90	0.022(#2)	CL	A1-D	T
	U-Factor 0.57			SHGC (>1) 0.18				VT (>1) 0.33		CR 46		
228	Inswing w/ Kickplate: ClimaGuard Neutral 70 / Arg / Clr - 27mm(6mm-5mm)											
	0.226	0.630	0.185					ARG90	0.171(#2)	CL	A1-D	N
	U-Factor 0.44			SHGC (N) 0.36				VT (N) 0.44		CR 46		
229	Inswing w/ Kickplate - NFRC Default: ClimaGuard Neutral 70 / Arg / Clr - 27mm(6mm-5mm)											
	0.226	0.630	0.185					ARG90	0.171(#2)	CL	A1-D	T
	U-Factor 0.58			SHGC (>1) 0.27				VT (>1) 0.32		CR 46		
230	Inswing w/ Kickplate: SNX 6227 / Arg / Clr - 24mm(4mm-4mm)											
	0.151	0.630	0.154					ARG90	0.020(#2)	CL	A1-D	N
	U-Factor 0.41			SHGC (N) 0.18				VT (N) 0.40		CR 47		

TEST REPORT FOR NEON ENERGY USA INC.

Report No: K0461.02-301-45 R3

Date: 12/18/20

SECTION 6 (Continued)

SIMULATION RESULTS

TOTAL PRODUCT CALCULATIONS (Ultra Outswing and Inswing Door)												
Option Number	Pane Thickness 1 (in)	Gap Width 1 (in)	Pane Thickness 2 (in)	Gap Width 2 (in)	Pane Thickness 3 (in)	Gap Width 3 (in)	Pane Thickness 4 (in)	Gap Fill	Low-e (Surface #)	Tint	Spacer	Grid Type
	U-Factor (Btu/Hr-Ft2-F)			Solar Heat Gain Coefficient (SHGC) Grids (None / <1 / >=1)				Visible Transmittance (VT) Grids (None / <1 / >=1)		Condensation Resistance (CR)		
231	Inswing w/ Kickplate - NFRC Default: SNX 6227 / Arg / Clr - 24mm(4mm-4mm)											
	0.151	0.630	0.154					ARG90	0.020(#2)	CL	A1-D	T
	U-Factor 0.56			SHGC (>1) 0.14				VT (>1) 0.30		CR 47		
232	Inswing w/ Kickplate: ClimaGuard Premium T / Arg / Clr - 24mm(4mm-4mm)											
	0.151	0.630	0.154					ARG90	0.035(#2)	CL	A1-D	N
	U-Factor 0.41			SHGC (N) 0.34				VT (N) 0.49		CR 47		
233	Inswing w/ Kickplate - NFRC Default: ClimaGuard Premium T / Arg / Clr - 24mm(4mm-4mm)											
	0.151	0.630	0.154					ARG90	0.035(#2)	CL	A1-D	T
	U-Factor 0.56			SHGC (>1) 0.26				VT (>1) 0.36		CR 47		
234	Inswing w/ Kickplate: SN 4023 / Arg / Clr - 24mm(4mm-4mm)											
	0.151	0.630	0.154					ARG90	0.026(#2)	CL	A1-D	N
	U-Factor 0.41			SHGC (N) 0.15				VT (N) 0.26		CR 47		
235	Inswing w/ Kickplate - NFRC Default: SN 4023 / Arg / Clr - 24mm(4mm-4mm)											
	0.151	0.630	0.154					ARG90	0.026(#2)	CL	A1-D	T
	U-Factor 0.56			SHGC (>1) 0.12				VT (>1) 0.19		CR 47		
236	Inswing w/ Kickplate: SN 5128 / Arg / Clr - 24mm(4mm-4mm)											
	0.151	0.630	0.154					ARG90	0.025(#2)	CL	A1-D	N
	U-Factor 0.41			SHGC (N) 0.18				VT (N) 0.33		CR 47		
237	Inswing w/ Kickplate - NFRC Default: SN 5128 / Arg / Clr - 24mm(4mm-4mm)											
	0.151	0.630	0.154					ARG90	0.025(#2)	CL	A1-D	T
	U-Factor 0.56			SHGC (>1) 0.14				VT (>1) 0.24		CR 47		
238	Inswing w/ Kickplate: SN 6234 / Arg / Clr - 24mm(4mm-4mm)											
	0.151	0.630	0.154					ARG90	0.026(#2)	CL	A1-D	N
	U-Factor 0.41			SHGC (N) 0.21				VT (N) 0.40		CR 47		
239	Inswing w/ Kickplate - NFRC Default: SN 6234 / Arg / Clr - 24mm(4mm-4mm)											
	0.151	0.630	0.154					ARG90	0.026(#2)	CL	A1-D	T
	U-Factor 0.56			SHGC (>1) 0.16				VT (>1) 0.30		CR 47		
240	Inswing w/ Kickplate: SN 7037 / Arg / Clr - 24mm(4mm-4mm)											
	0.151	0.630	0.154					ARG90	0.022(#2)	CL	A1-D	N
	U-Factor 0.41			SHGC (N) 0.23				VT (N) 0.45		CR 47		

TEST REPORT FOR NEON ENERGY USA INC.

Report No: K0461.02-301-45 R3

Date: 12/18/20

SECTION 6 (Continued)

SIMULATION RESULTS

TOTAL PRODUCT CALCULATIONS (Ultra Outswing and Inswing Door)												
Option Number	Pane Thickness 1 (in)	Gap Width 1 (in)	Pane Thickness 2 (in)	Gap Width 2 (in)	Pane Thickness 3 (in)	Gap Width 3 (in)	Pane Thickness 4 (in)	Gap Fill	Low-e (Surface #)	Tint	Spacer	Grid Type
	U-Factor (Btu/Hr-Ft2-F)			Solar Heat Gain Coefficient (SHGC) Grids (None / <1 / >=1)				Visible Transmittance (VT) Grids (None / <1 / >=1)		Condensation Resistance (CR)		
241	Inswing w/ Kickplate - NFRC Default: SN 7037 / Arg / Clr - 24mm(4mm-4mm)											
	0.151	0.630	0.154					ARG90	0.022(#2)	CL	A1-D	T
	U-Factor 0.56			SHGC (>1) 0.18				VT (>1) 0.33		CR 47		
242	Inswing w/ Kickplate: ClimaGuard Neutral 70 / Arg / Clr - 24mm(4mm-4mm)											
	0.148	0.630	0.154					ARG90	0.171(#2)	CL	A1-D	N
	U-Factor 0.44			SHGC (N) 0.37				VT (N) 0.44		CR 46		
243	Inswing w/ Kickplate - NFRC Default: ClimaGuard Neutral 70 / Arg / Clr - 24mm(4mm-4mm)											
	0.148	0.630	0.154					ARG90	0.171(#2)	CL	A1-D	T
	U-Factor 0.57			SHGC (>1) 0.28				VT (>1) 0.32		CR 46		
244	Inswing w/ Kickplate: ClimaGuard Neutral 70 / Arg / Clr - 28mm(6mm-5mm)											
	0.226	0.670	0.185					ARG90	0.171(#2)	CL	A1-D	N
	U-Factor 0.44			SHGC (N) 0.36				VT (N) 0.44		CR 46		
245	Inswing w/ Kickplate - NFRC Default: ClimaGuard Neutral 70 / Arg / Clr - 28mm(6mm-5mm)											
	0.226	0.670	0.185					ARG90	0.171(#2)	CL	A1-D	T
	U-Factor 0.59			SHGC (>1) 0.27				VT (>1) 0.32		CR 46		
246	Inswing w/ Kickplate: ClimaGuard Neutral 70 / Arg / Clr - 28mm(4mm-4mm)											
	0.226	0.787	0.185					ARG90	0.171(#2)	CL	A1-D	N
	U-Factor 0.44			SHGC (N) 0.36				VT (N) 0.44		CR 45		
247	Inswing w/ Kickplate - NFRC Default: ClimaGuard Neutral 70 / Arg / Clr - 28mm(4mm-4mm)											
	0.226	0.787	0.185					ARG90	0.171(#2)	CL	A1-D	T
	U-Factor 0.60			SHGC (>1) 0.27				VT (>1) 0.32		CR 44		
248	Inswing w/ Kickplate: SNX 6227 / Arg / SNX 6227 / Arg / Clr - 36mm(4mm-4mm-4mm)											
	0.151	0.470	0.151	0.470	0.154			ARG90	0.020(#2) / 0.020(#4)	CL	TS-D	N
	U-Factor 0.31			SHGC (N) 0.14				VT (N) 0.28		CR 48		
249	Inswing w/ Kickplate: SNX 6227 / Arg / SNX 6227 / Arg / Clr - 41mm(6mm-6mm-5mm)											
	0.221	0.470	0.221	0.470	0.185			ARG90	0.020(#2) / 0.020(#4)	CL	TS-D	N
	U-Factor 0.31			SHGC (N) 0.14				VT (N) 0.28		CR 48		
250	Inswing w/ Kickplate: SNX 5123 / Arg / SNX 5123 / Arg / Clr - 41mm(6mm-6mm-5mm)											
	0.221	0.470	0.221	0.470	0.185			ARG90	0.021(#2) / 0.021(#4)	CL	TS-D	N
	U-Factor 0.31			SHGC (N) 0.11				VT (N) 0.19		CR 48		

TEST REPORT FOR NEON ENERGY USA INC.

Report No: K0461.02-301-45 R3

Date: 12/18/20

SECTION 6 (Continued)

SIMULATION RESULTS

TOTAL PRODUCT CALCULATIONS (Ultra Outswing and Inswing Door)												
Option Number	Pane Thickness 1 (in)	Gap Width 1 (in)	Pane Thickness 2 (in)	Gap Width 2 (in)	Pane Thickness 3 (in)	Gap Width 3 (in)	Pane Thickness 4 (in)	Gap Fill	Low-e (Surface #)	Tint	Spacer	Grid Type
	U-Factor (Btu/Hr-Ft ² -F)			Solar Heat Gain Coefficient (SHGC) Grids (None / <1 / >=1)				Visible Transmittance (VT) Grids (None / <1 / >=1)		Condensation Resistance (CR)		
251	Inswing w/ Kickplate: SNX 5123 / Arg / 3mmClr-030PVB-3mmIS20 - 28mm (6mm-6mm)											
	0.221	0.625	0.264					ARG90	0.021(#2) / 0.198(#4)	CL	TS-D	N
	U-Factor 0.36			SHGC (N) 0.15				VT (N) 0.32		CR 48		
252	Inswing w/ Kickplate - NFRC Default: SNX 5123 / Arg / 3mmClr-030PVB-3mmIS20 - 28mm (6mm-6mm)											
	0.221	0.625	0.264					ARG90	0.021(#2) / 0.198(#4)	CL	TS-D	T
	U-Factor 0.48			SHGC (>1) 0.12				VT (>1) 0.23		CR 48		
253	Inswing w/ Kickplate - 1 Horizontal TD: SNX 5123 / Arg / Clr - 28mm(6mm-6mm)											
	0.221	0.630	0.224					ARG90	0.021(#2)	CL	A1-D	T
	U-Factor 0.42			SHGC (>1) 0.12				VT (>1) 0.24		CR 46		
254	Inswing w/ Kickplate - 1 Horizontal TD: SNX 6227 / Arg / Clr - 28mm(6mm-6mm)											
	0.221	0.630	0.224					ARG90	0.020(#2)	CL	A1-D	T
	U-Factor 0.42			SHGC (>1) 0.14				VT (>1) 0.29		CR 46		
255	Inswing w/ Kickplate - 1 Horizontal TD: ClimaGuard Premium T / Arg / Clr - 27mm(6mm-5mm)											
	0.230	0.630	0.185					ARG90	0.035(#2)	CL	A1-D	T
	U-Factor 0.42			SHGC (>1) 0.26				VT (>1) 0.36		CR 46		
256	Inswing w/ Kickplate - 1 Horizontal TD: SN 4023 / Arg / Clr - 27mm(6mm-5mm)											
	0.230	0.630	0.185					ARG90	0.026(#2)	CL	A1-D	T
	U-Factor 0.42			SHGC (>1) 0.12				VT (>1) 0.19		CR 46		
257	Inswing w/ Kickplate - 1 Horizontal TD: SN 5128 / Arg / Clr - 27mm(6mm-5mm)											
	0.230	0.630	0.185					ARG90	0.025(#2)	CL	A1-D	T
	U-Factor 0.42			SHGC (>1) 0.14				VT (>1) 0.24		CR 46		
258	Inswing w/ Kickplate - 1 Horizontal TD: SN 6234 / Arg / Clr - 27mm(6mm-5mm)											
	0.230	0.630	0.185					ARG90	0.026(#2)	CL	A1-D	T
	U-Factor 0.42			SHGC (>1) 0.16				VT (>1) 0.29		CR 46		
259	Inswing w/ Kickplate - 1 Horizontal TD: SN 7037 / Arg / Clr - 27mm(6mm-5mm)											
	0.230	0.630	0.185					ARG90	0.022(#2)	CL	A1-D	T
	U-Factor 0.42			SHGC (>1) 0.18				VT (>1) 0.33		CR 46		
260	Inswing w/ Kickplate - 1 Horizontal TD: ClimaGuard Neutral 70 / Arg / Clr - 27mm(6mm-5mm)											
	0.226	0.630	0.185					ARG90	0.171(#2)	CL	A1-D	T
	U-Factor 0.45			SHGC (>1) 0.27				VT (>1) 0.32		CR 46		

TEST REPORT FOR NEON ENERGY USA INC.

Report No: K0461.02-301-45 R3

Date: 12/18/20

SECTION 6 (Continued)

SIMULATION RESULTS

TOTAL PRODUCT CALCULATIONS (Ultra Outswing and Inswing Door)												
Option Number	Pane Thickness 1 (in)	Gap Width 1 (in)	Pane Thickness 2 (in)	Gap Width 2 (in)	Pane Thickness 3 (in)	Gap Width 3 (in)	Pane Thickness 4 (in)	Gap Fill	Low-e (Surface #)	Tint	Spacer	Grid Type
	U-Factor (Btu/Hr-Ft2-F)			Solar Heat Gain Coefficient (SHGC) Grids (None / <1 / >=1)				Visible Transmittance (VT) Grids (None / <1 / >=1)		Condensation Resistance (CR)		
261	Inswing w/ Kickplate - 1 Horizontal TDL: SNX 6227 / Arg / Clr - 24mm(4mm-4mm)											
	0.151	0.630	0.154					ARG90	0.020(#2)	CL	A1-D	T
	U-Factor 0.42			SHGC (>1) 0.14				VT (>1) 0.30		CR 47		
262	Inswing w/ Kickplate - 1 Horizontal TDL: ClimaGuard Premium T / Arg / Clr - 24mm(4mm-4mm)											
	0.151	0.630	0.154					ARG90	0.035(#2)	CL	A1-D	T
	U-Factor 0.42			SHGC (>1) 0.26				VT (>1) 0.36		CR 47		
263	Inswing w/ Kickplate - 1 Horizontal TDL: SN 4023 / Arg / Clr - 24mm(4mm-4mm)											
	0.151	0.630	0.154					ARG90	0.026(#2)	CL	A1-D	T
	U-Factor 0.42			SHGC (>1) 0.12				VT (>1) 0.19		CR 47		
264	Inswing w/ Kickplate - 1 Horizontal TDL: SN 5128 / Arg / Clr - 24mm(4mm-4mm)											
	0.151	0.630	0.154					ARG90	0.025(#2)	CL	A1-D	T
	U-Factor 0.42			SHGC (>1) 0.14				VT (>1) 0.24		CR 47		
265	Inswing w/ Kickplate - 1 Horizontal TDL: SN 6234 / Arg / Clr - 24mm(4mm-4mm)											
	0.151	0.630	0.154					ARG90	0.026(#2)	CL	A1-D	T
	U-Factor 0.42			SHGC (>1) 0.16				VT (>1) 0.30		CR 47		
266	Inswing w/ Kickplate - 1 Horizontal TDL: SN 7037 / Arg / Clr - 24mm(4mm-4mm)											
	0.151	0.630	0.154					ARG90	0.022(#2)	CL	A1-D	T
	U-Factor 0.42			SHGC (>1) 0.18				VT (>1) 0.33		CR 47		
267	Inswing w/ Kickplate - 1 Horizontal TDL: ClimaGuard Neutral 70 / Arg / Clr - 24mm(4mm-4mm)											
	0.148	0.630	0.154					ARG90	0.171(#2)	CL	A1-D	T
	U-Factor 0.45			SHGC (>1) 0.28				VT (>1) 0.32		CR 46		
268	Inswing w/ Kickplate - 1 Horizontal TDL: ClimaGuard Neutral 70 / Arg / Clr - 28mm(6mm-5mm)											
	0.226	0.670	0.185					ARG90	0.171(#2)	CL	A1-D	T
	U-Factor 0.45			SHGC (>1) 0.27				VT (>1) 0.32		CR 46		
269	Inswing w/ Kickplate - 1 Horizontal TDL: ClimaGuard Neutral 70 / Arg / Clr - 28mm(4mm-4mm)											
	0.226	0.787	0.185					ARG90	0.171(#2)	CL	A1-D	T
	U-Factor 0.46			SHGC (>1) 0.27				VT (>1) 0.32		CR 45		
270	Inswing w/ Kickplate - 1 Horizontal TDL: SNX 5123 / Arg / 3mmClr-030PVB-3mmIS20 - 28mm (6mm-6mm)											
	0.221	0.625	0.264					ARG90	0.021(#2) / 0.198(#4)	CL	TS-D	T
	U-Factor 0.37			SHGC (>1) 0.12				VT (>1) 0.23		CR 48		

TEST REPORT FOR NEON ENERGY USA INC.

Report No: K0461.02-301-45 R3

Date: 12/18/20

SECTION 6 (Continued)

SIMULATION RESULTS

TOTAL PRODUCT CALCULATIONS (Ultra Outswing and Inswing Door)												
Option Number	Pane Thickness 1 (in)	Gap Width 1 (in)	Pane Thickness 2 (in)	Gap Width 2 (in)	Pane Thickness 3 (in)	Gap Width 3 (in)	Pane Thickness 4 (in)	Gap Fill	Low-e (Surface #)	Tint	Spacer	Grid Type
	U-Factor (Btu/Hr-Ft2-F)			Solar Heat Gain Coefficient (SHGC) Grids (None / <1 / >=1)				Visible Transmittance (VT) Grids (None / <1 / >=1)		Condensation Resistance (CR)		
271	Inswing w/ Kickplate - 2 Horizontal TDLS: SNX 5123 / Arg / Clr - 28mm(6mm-6mm)											
	0.221	0.630	0.224					ARG90	0.021(#2)	CL	A1-D	T
	U-Factor 0.44			SHGC (>1) 0.12				VT (>1) 0.24		CR 46		
272	Inswing w/ Kickplate - 2 Horizontal TDLS: SNX 6227 / Arg / Clr - 28mm(6mm-6mm)											
	0.221	0.630	0.224					ARG90	0.020(#2)	CL	A1-D	T
	U-Factor 0.44			SHGC (>1) 0.14				VT (>1) 0.29		CR 46		
273	Inswing w/ Kickplate - 2 Horizontal TDLS: ClimaGuard Premium T / Arg / Clr - 27mm(6mm-5mm)											
	0.230	0.630	0.185					ARG90	0.035(#2)	CL	A1-D	T
	U-Factor 0.44			SHGC (>1) 0.26				VT (>1) 0.36		CR 46		
274	Inswing w/ Kickplate - 2 Horizontal TDLS: SN 4023 / Arg / Clr - 27mm(6mm-5mm)											
	0.230	0.630	0.185					ARG90	0.026(#2)	CL	A1-D	T
	U-Factor 0.44			SHGC (>1) 0.12				VT (>1) 0.19		CR 46		
275	Inswing w/ Kickplate - 2 Horizontal TDLS: SN 5128 / Arg / Clr - 27mm(6mm-5mm)											
	0.230	0.630	0.185					ARG90	0.025(#2)	CL	A1-D	T
	U-Factor 0.44			SHGC (>1) 0.14				VT (>1) 0.24		CR 46		
276	Inswing w/ Kickplate - 2 Horizontal TDLS: SN 6234 / Arg / Clr - 27mm(6mm-5mm)											
	0.230	0.630	0.185					ARG90	0.026(#2)	CL	A1-D	T
	U-Factor 0.44			SHGC (>1) 0.16				VT (>1) 0.29		CR 46		
277	Inswing w/ Kickplate - 2 Horizontal TDLS: SN 7037 / Arg / Clr - 27mm(6mm-5mm)											
	0.230	0.630	0.185					ARG90	0.022(#2)	CL	A1-D	T
	U-Factor 0.44			SHGC (>1) 0.18				VT (>1) 0.33		CR 46		
278	Inswing w/ Kickplate - 2 Horizontal TDLS: ClimaGuard Neutral 70 / Arg / Clr - 27mm(6mm-5mm)											
	0.226	0.630	0.185					ARG90	0.171(#2)	CL	A1-D	T
	U-Factor 0.46			SHGC (>1) 0.27				VT (>1) 0.32		CR 46		
279	Inswing w/ Kickplate - 2 Horizontal TDLS: SNX 6227 / Arg / Clr - 24mm(4mm-4mm)											
	0.151	0.630	0.154					ARG90	0.020(#2)	CL	A1-D	T
	U-Factor 0.43			SHGC (>1) 0.14				VT (>1) 0.30		CR 47		
280	Inswing w/ Kickplate - 2 Horizontal TDLS: ClimaGuard Premium T / Arg / Clr - 24mm(4mm-4mm)											
	0.151	0.630	0.154					ARG90	0.035(#2)	CL	A1-D	T
	U-Factor 0.44			SHGC (>1) 0.26				VT (>1) 0.36		CR 47		

TEST REPORT FOR NEON ENERGY USA INC.

Report No: K0461.02-301-45 R3

Date: 12/18/20

SECTION 6 (Continued) SIMULATION RESULTS

TOTAL PRODUCT CALCULATIONS (Ultra Outswing and Inswing Door)												
Option Number	Pane Thickness 1 (in)	Gap Width 1 (in)	Pane Thickness 2 (in)	Gap Width 2 (in)	Pane Thickness 3 (in)	Gap Width 3 (in)	Pane Thickness 4 (in)	Gap Fill	Low-e (Surface #)	Tint	Spacer	Grid Type
	U-Factor (Btu/Hr-Ft2-F)			Solar Heat Gain Coefficient (SHGC) Grids (None / <1 / >=1)				Visible Transmittance (VT) Grids (None / <1 / >=1)		Condensation Resistance (CR)		
281	Inswing w/ Kickplate - 2 Horizontal TDLS: SN 4023 / Arg / Clr - 24mm(4mm-4mm)											
	0.151	0.630	0.154					ARG90	0.026(#2)	CL	A1-D	T
	U-Factor 0.44			SHGC (>1) 0.12				VT (>1) 0.19		CR 47		
282	Inswing w/ Kickplate - 2 Horizontal TDLS: SN 5128 / Arg / Clr - 24mm(4mm-4mm)											
	0.151	0.630	0.154					ARG90	0.025(#2)	CL	A1-D	T
	U-Factor 0.44			SHGC (>1) 0.14				VT (>1) 0.24		CR 47		
283	Inswing w/ Kickplate - 2 Horizontal TDLS: SN 6234 / Arg / Clr - 24mm(4mm-4mm)											
	0.151	0.630	0.154					ARG90	0.026(#2)	CL	A1-D	T
	U-Factor 0.44			SHGC (>1) 0.16				VT (>1) 0.30		CR 47		
284	Inswing w/ Kickplate - 2 Horizontal TDLS: SN 7037 / Arg / Clr - 24mm(4mm-4mm)											
	0.151	0.630	0.154					ARG90	0.022(#2)	CL	A1-D	T
	U-Factor 0.44			SHGC (>1) 0.18				VT (>1) 0.33		CR 47		
285	Inswing w/ Kickplate - 2 Horizontal TDLS: ClimaGuard Neutral 70 / Arg / Clr - 24mm(4mm-4mm)											
	0.148	0.630	0.154					ARG90	0.171(#2)	CL	A1-D	T
	U-Factor 0.46			SHGC (>1) 0.28				VT (>1) 0.32		CR 46		
286	Inswing w/ Kickplate - 2 Horizontal TDLS: ClimaGuard Neutral 70 / Arg / Clr - 28mm(6mm-5mm)											
	0.226	0.670	0.185					ARG90	0.171(#2)	CL	A1-D	T
	U-Factor 0.47			SHGC (>1) 0.27				VT (>1) 0.32		CR 46		
287	Inswing w/ Kickplate - 2 Horizontal TDLS: ClimaGuard Neutral 70 / Arg / Clr - 28mm(4mm-4mm)											
	0.226	0.787	0.185					ARG90	0.171(#2)	CL	A1-D	T
	U-Factor 0.47			SHGC (>1) 0.27				VT (>1) 0.32		CR 45		
288	Inswing w/ Kickplate - 2 Horizontal TDLS: SNX 5123 / Arg / 3mmClr-030PVB-3mmIS20 - 28mm (6mm-6mm)											
	0.221	0.625	0.264					ARG90	0.021(#2) / 0.198(#4)	CL	TS-D	T
	U-Factor 0.38			SHGC (>1) 0.12				VT (>1) 0.23		CR 48		
289	Inswing w/ Kickplate - 3 Horizontal TDLS: SNX 5123 / Arg / Clr - 28mm(6mm-6mm)											
	0.221	0.630	0.224					ARG90	0.021(#2)	CL	A1-D	T
	U-Factor 0.45			SHGC (>1) 0.12				VT (>1) 0.24		CR 46		
290	Inswing w/ Kickplate - 3 Horizontal TDLS: SNX 6227 / Arg / Clr - 28mm(6mm-6mm)											
	0.221	0.630	0.224					ARG90	0.020(#2)	CL	A1-D	T
	U-Factor 0.45			SHGC (>1) 0.14				VT (>1) 0.29		CR 46		

TEST REPORT FOR NEON ENERGY USA INC.

Report No: K0461.02-301-45 R3

Date: 12/18/20

SECTION 6 (Continued)

SIMULATION RESULTS

TOTAL PRODUCT CALCULATIONS (Ultra Outswing and Inswing Door)												
Option Number	Pane Thickness 1 (in)	Gap Width 1 (in)	Pane Thickness 2 (in)	Gap Width 2 (in)	Pane Thickness 3 (in)	Gap Width 3 (in)	Pane Thickness 4 (in)	Gap Fill	Low-e (Surface #)	Tint	Spacer	Grid Type
	U-Factor (Btu/Hr-Ft ² -F)			Solar Heat Gain Coefficient (SHGC) Grids (None / <1 / >=1)				Visible Transmittance (VT) Grids (None / <1 / >=1)		Condensation Resistance (CR)		
291	Inswing w/ Kickplate - 3 Horizontal TDLS: ClimaGuard Premium T / Arg / Clr - 27mm(6mm-5mm)											
	0.230	0.630	0.185					ARG90	0.035(#2)	CL	A1-D	T
	U-Factor 0.45			SHGC (>1) 0.26				VT (>1) 0.36		CR 46		
292	Inswing w/ Kickplate - 3 Horizontal TDLS: SN 4023 / Arg / Clr - 27mm(6mm-5mm)											
	0.230	0.630	0.185					ARG90	0.026(#2)	CL	A1-D	T
	U-Factor 0.45			SHGC (>1) 0.12				VT (>1) 0.19		CR 46		
293	Inswing w/ Kickplate - 3 Horizontal TDLS: SN 5128 / Arg / Clr - 27mm(6mm-5mm)											
	0.230	0.630	0.185					ARG90	0.025(#2)	CL	A1-D	T
	U-Factor 0.45			SHGC (>1) 0.14				VT (>1) 0.24		CR 46		
294	Inswing w/ Kickplate - 3 Horizontal TDLS: SN 6234 / Arg / Clr - 27mm(6mm-5mm)											
	0.230	0.630	0.185					ARG90	0.026(#2)	CL	A1-D	T
	U-Factor 0.45			SHGC (>1) 0.16				VT (>1) 0.29		CR 46		
295	Inswing w/ Kickplate - 3 Horizontal TDLS: SN 7037 / Arg / Clr - 27mm(6mm-5mm)											
	0.230	0.630	0.185					ARG90	0.022(#2)	CL	A1-D	T
	U-Factor 0.45			SHGC (>1) 0.18				VT (>1) 0.33		CR 46		
296	Inswing w/ Kickplate - 3 Horizontal TDLS: ClimaGuard Neutral 70 / Arg / Clr - 27mm(6mm-5mm)											
	0.226	0.630	0.185					ARG90	0.171(#2)	CL	A1-D	T
	U-Factor 0.48			SHGC (>1) 0.27				VT (>1) 0.32		CR 46		
297	Inswing w/ Kickplate - 3 Horizontal TDLS: SNX 6227 / Arg / Clr - 24mm(4mm-4mm)											
	0.151	0.630	0.154					ARG90	0.020(#2)	CL	A1-D	T
	U-Factor 0.45			SHGC (>1) 0.14				VT (>1) 0.30		CR 47		
298	Inswing w/ Kickplate - 3 Horizontal TDLS: ClimaGuard Premium T / Arg / Clr - 24mm(4mm-4mm)											
	0.151	0.630	0.154					ARG90	0.035(#2)	CL	A1-D	T
	U-Factor 0.45			SHGC (>1) 0.26				VT (>1) 0.36		CR 47		
299	Inswing w/ Kickplate - 3 Horizontal TDLS: SN 4023 / Arg / Clr - 24mm(4mm-4mm)											
	0.151	0.630	0.154					ARG90	0.026(#2)	CL	A1-D	T
	U-Factor 0.45			SHGC (>1) 0.12				VT (>1) 0.19		CR 47		
300	Inswing w/ Kickplate - 3 Horizontal TDLS: SN 5128 / Arg / Clr - 24mm(4mm-4mm)											
	0.151	0.630	0.154					ARG90	0.025(#2)	CL	A1-D	T
	U-Factor 0.45			SHGC (>1) 0.14				VT (>1) 0.24		CR 47		

TEST REPORT FOR NEON ENERGY USA INC.

Report No: K0461.02-301-45 R3

Date: 12/18/20

SECTION 6 (Continued)

SIMULATION RESULTS

TOTAL PRODUCT CALCULATIONS (Ultra Outswing and Inswing Door)												
Option Number	Pane Thickness 1 (in)	Gap Width 1 (in)	Pane Thickness 2 (in)	Gap Width 2 (in)	Pane Thickness 3 (in)	Gap Width 3 (in)	Pane Thickness 4 (in)	Gap Fill	Low-e (Surface #)	Tint	Spacer	Grid Type
	U-Factor (Btu/Hr-Ft2-F)			Solar Heat Gain Coefficient (SHGC) Grids (None / <1 / >=1)				Visible Transmittance (VT) Grids (None / <1 / >=1)		Condensation Resistance (CR)		
301	Inswing w/ Kickplate - 3 Horizontal TDLS: SN 6234 / Arg / Clr - 24mm(4mm-4mm)											
	0.151	0.630	0.154					ARG90	0.026(#2)	CL	A1-D	T
	U-Factor 0.45			SHGC (>1) 0.16				VT (>1) 0.30		CR 47		
302	Inswing w/ Kickplate - 3 Horizontal TDLS: SN 7037 / Arg / Clr - 24mm(4mm-4mm)											
	0.151	0.630	0.154					ARG90	0.022(#2)	CL	A1-D	T
	U-Factor 0.45			SHGC (>1) 0.18				VT (>1) 0.33		CR 47		
303	Inswing w/ Kickplate - 3 Horizontal TDLS: ClimaGuard Neutral 70 / Arg / Clr - 24mm(4mm-4mm)											
	0.148	0.630	0.154					ARG90	0.171(#2)	CL	A1-D	T
	U-Factor 0.48			SHGC (>1) 0.28				VT (>1) 0.32		CR 46		
304	Inswing w/ Kickplate - 3 Horizontal TDLS: ClimaGuard Neutral 70 / Arg / Clr - 28mm(6mm-5mm)											
	0.226	0.670	0.185					ARG90	0.171(#2)	CL	A1-D	T
	U-Factor 0.48			SHGC (>1) 0.27				VT (>1) 0.32		CR 46		
305	Inswing w/ Kickplate - 3 Horizontal TDLS: ClimaGuard Neutral 70 / Arg / Clr - 28mm(4mm-4mm)											
	0.226	0.787	0.185					ARG90	0.171(#2)	CL	A1-D	T
	U-Factor 0.49			SHGC (>1) 0.27				VT (>1) 0.32		CR 45		
306	Inswing w/ Kickplate - 3 Horizontal TDLS: SNX 5123 / Arg / 3mmClr-030PVB-3mmIS20 - 28mm (6mm-6mm)											
	0.221	0.625	0.264					ARG90	0.021(#2) / 0.198(#4)	CL	TS-D	T
	U-Factor 0.39			SHGC (>1) 0.12				VT (>1) 0.23		CR 48		
307	Inswing w/ Kickplate - 4 Horizontal TDLS: SNX 5123 / Arg / Clr - 28mm(6mm-6mm)											
	0.221	0.630	0.224					ARG90	0.021(#2)	CL	A1-D	T
	U-Factor 0.47			SHGC (>1) 0.12				VT (>1) 0.24		CR 46		
308	Inswing w/ Kickplate - 4 Horizontal TDLS: SNX 6227 / Arg / Clr - 28mm(6mm-6mm)											
	0.221	0.630	0.224					ARG90	0.020(#2)	CL	A1-D	T
	U-Factor 0.47			SHGC (>1) 0.14				VT (>1) 0.29		CR 46		
309	Inswing w/ Kickplate - 4 Horizontal TDLS: ClimaGuard Premium T / Arg / Clr - 27mm(6mm-5mm)											
	0.230	0.630	0.185					ARG90	0.035(#2)	CL	A1-D	T
	U-Factor 0.47			SHGC (>1) 0.26				VT (>1) 0.36		CR 46		
310	Inswing w/ Kickplate - 4 Horizontal TDLS: SN 4023 / Arg / Clr - 27mm(6mm-5mm)											
	0.230	0.630	0.185					ARG90	0.026(#2)	CL	A1-D	T
	U-Factor 0.47			SHGC (>1) 0.12				VT (>1) 0.19		CR 46		

TEST REPORT FOR NEON ENERGY USA INC.

Report No: K0461.02-301-45 R3

Date: 12/18/20

SECTION 6 (Continued) SIMULATION RESULTS

TOTAL PRODUCT CALCULATIONS (Ultra Outswing and Inswing Door)												
Option Number	Pane Thickness 1 (in)	Gap Width 1 (in)	Pane Thickness 2 (in)	Gap Width 2 (in)	Pane Thickness 3 (in)	Gap Width 3 (in)	Pane Thickness 4 (in)	Gap Fill	Low-e (Surface #)	Tint	Spacer	Grid Type
	U-Factor (Btu/Hr-Ft2-F)			Solar Heat Gain Coefficient (SHGC) Grids (None / <1 / >=1)				Visible Transmittance (VT) Grids (None / <1 / >=1)		Condensation Resistance (CR)		
311	Inswing w/ Kickplate - 4 Horizontal TDLS: SN 5128 / Arg / Clr - 27mm(6mm-5mm)											
	0.230	0.630	0.185					ARG90	0.025(#2)	CL	A1-D	T
	U-Factor 0.47			SHGC (>1) 0.14				VT (>1) 0.24		CR 46		
312	Inswing w/ Kickplate - 4 Horizontal TDLS: SN 6234 / Arg / Clr - 27mm(6mm-5mm)											
	0.230	0.630	0.185					ARG90	0.026(#2)	CL	A1-D	T
	U-Factor 0.47			SHGC (>1) 0.16				VT (>1) 0.29		CR 46		
313	Inswing w/ Kickplate - 4 Horizontal TDLS: SN 7037 / Arg / Clr - 27mm(6mm-5mm)											
	0.230	0.630	0.185					ARG90	0.022(#2)	CL	A1-D	T
	U-Factor 0.47			SHGC (>1) 0.18				VT (>1) 0.33		CR 46		
314	Inswing w/ Kickplate - 4 Horizontal TDLS: ClimaGuard Neutral 70 / Arg / Clr - 27mm(6mm-5mm)											
	0.226	0.630	0.185					ARG90	0.171(#2)	CL	A1-D	T
	U-Factor 0.49			SHGC (>1) 0.27				VT (>1) 0.32		CR 46		
315	Inswing w/ Kickplate - 4 Horizontal TDLS: SNX 6227 / Arg / Clr - 24mm(4mm-4mm)											
	0.151	0.630	0.154					ARG90	0.020(#2)	CL	A1-D	T
	U-Factor 0.46			SHGC (>1) 0.14				VT (>1) 0.30		CR 47		
316	Inswing w/ Kickplate - 4 Horizontal TDLS: ClimaGuard Premium T / Arg / Clr - 24mm(4mm-4mm)											
	0.151	0.630	0.154					ARG90	0.035(#2)	CL	A1-D	T
	U-Factor 0.47			SHGC (>1) 0.26				VT (>1) 0.36		CR 47		
317	Inswing w/ Kickplate - 4 Horizontal TDLS: SN 4023 / Arg / Clr - 24mm(4mm-4mm)											
	0.151	0.630	0.154					ARG90	0.026(#2)	CL	A1-D	T
	U-Factor 0.46			SHGC (>1) 0.12				VT (>1) 0.19		CR 47		
318	Inswing w/ Kickplate - 4 Horizontal TDLS: SN 5128 / Arg / Clr - 24mm(4mm-4mm)											
	0.151	0.630	0.154					ARG90	0.025(#2)	CL	A1-D	T
	U-Factor 0.46			SHGC (>1) 0.14				VT (>1) 0.24		CR 47		
319	Inswing w/ Kickplate - 4 Horizontal TDLS: SN 6234 / Arg / Clr - 24mm(4mm-4mm)											
	0.151	0.630	0.154					ARG90	0.026(#2)	CL	A1-D	T
	U-Factor 0.46			SHGC (>1) 0.16				VT (>1) 0.30		CR 47		
320	Inswing w/ Kickplate - 4 Horizontal TDLS: SN 7037 / Arg / Clr - 24mm(4mm-4mm)											
	0.151	0.630	0.154					ARG90	0.022(#2)	CL	A1-D	T
	U-Factor 0.46			SHGC (>1) 0.18				VT (>1) 0.33		CR 47		

TEST REPORT FOR NEON ENERGY USA INC.

Report No: K0461.02-301-45 R3

Date: 12/18/20

SECTION 6 (Continued)

SIMULATION RESULTS

TOTAL PRODUCT CALCULATIONS (Ultra Outswing and Inswing Door)												
Option Number	Pane Thickness 1 (in)	Gap Width 1 (in)	Pane Thickness 2 (in)	Gap Width 2 (in)	Pane Thickness 3 (in)	Gap Width 3 (in)	Pane Thickness 4 (in)	Gap Fill	Low-e (Surface #)	Tint	Spacer	Grid Type
	U-Factor (Btu/Hr-Ft ² -F)			Solar Heat Gain Coefficient (SHGC) Grids (None / <1 / >=1)				Visible Transmittance (VT) Grids (None / <1 / >=1)		Condensation Resistance (CR)		
321	Inswing w/ Kickplate - 4 Horizontal TDLS: ClimaGuard Neutral 70 / Arg / Clr - 24mm(4mm-4mm)											
	0.148	0.630	0.154					ARG90	0.171(#2)	CL	A1-D	T
	U-Factor 0.49			SHGC (>1) 0.28				VT (>1) 0.32		CR 46		
322	Inswing w/ Kickplate - 4 Horizontal TDLS: ClimaGuard Neutral 70 / Arg / Clr - 28mm(6mm-5mm)											
	0.226	0.670	0.185					ARG90	0.171(#2)	CL	A1-D	T
	U-Factor 0.49			SHGC (>1) 0.27				VT (>1) 0.32		CR 46		
323	Inswing w/ Kickplate - 4 Horizontal TDLS: ClimaGuard Neutral 70 / Arg / Clr - 28mm(4mm-4mm)											
	0.226	0.787	0.185					ARG90	0.171(#2)	CL	A1-D	T
	U-Factor 0.50			SHGC (>1) 0.27				VT (>1) 0.32		CR 45		
324	Inswing w/ Kickplate - 4 Horizontal TDLS: SNX 5123 / Arg / 3mmClr-030PVB-3mmIS20 - 28mm (6mm-6mm)											
	0.221	0.625	0.264					ARG90	0.021(#2) / 0.198(#4)	CL	TS-D	T
	U-Factor 0.40			SHGC (>1) 0.12				VT (>1) 0.23		CR 48		
325	Inswing w/ Kickplate - 1 Vertical TDL: SNX 5123 / Arg / Clr - 28mm(6mm-6mm)											
	0.221	0.630	0.224					ARG90	0.021(#2)	CL	A1-D	T
	U-Factor 0.44			SHGC (>1) 0.12				VT (>1) 0.24		CR 46		
326	Inswing w/ Kickplate - 1 Vertical TDL: SNX 6227 / Arg / Clr - 28mm(6mm-6mm)											
	0.221	0.630	0.224					ARG90	0.020(#2)	CL	A1-D	T
	U-Factor 0.44			SHGC (>1) 0.14				VT (>1) 0.29		CR 46		
327	Inswing w/ Kickplate - 1 Vertical TDL: ClimaGuard Premium T / Arg / Clr - 27mm(6mm-5mm)											
	0.230	0.630	0.185					ARG90	0.035(#2)	CL	A1-D	T
	U-Factor 0.45			SHGC (>1) 0.26				VT (>1) 0.36		CR 46		
328	Inswing w/ Kickplate - 1 Vertical TDL: SN 4023 / Arg / Clr - 27mm(6mm-5mm)											
	0.230	0.630	0.185					ARG90	0.026(#2)	CL	A1-D	T
	U-Factor 0.44			SHGC (>1) 0.12				VT (>1) 0.19		CR 46		
329	Inswing w/ Kickplate - 1 Vertical TDL: SN 5128 / Arg / Clr - 27mm(6mm-5mm)											
	0.230	0.630	0.185					ARG90	0.025(#2)	CL	A1-D	T
	U-Factor 0.44			SHGC (>1) 0.14				VT (>1) 0.24		CR 46		
330	Inswing w/ Kickplate - 1 Vertical TDL: SN 6234 / Arg / Clr - 27mm(6mm-5mm)											
	0.230	0.630	0.185					ARG90	0.026(#2)	CL	A1-D	T
	U-Factor 0.44			SHGC (>1) 0.16				VT (>1) 0.29		CR 46		

TEST REPORT FOR NEON ENERGY USA INC.

Report No: K0461.02-301-45 R3

Date: 12/18/20

SECTION 6 (Continued)

SIMULATION RESULTS

TOTAL PRODUCT CALCULATIONS (Ultra Outswing and Inswing Door)												
Option Number	Pane Thickness 1 (in)	Gap Width 1 (in)	Pane Thickness 2 (in)	Gap Width 2 (in)	Pane Thickness 3 (in)	Gap Width 3 (in)	Pane Thickness 4 (in)	Gap Fill	Low-e (Surface #)	Tint	Spacer	Grid Type
	U-Factor (Btu/Hr-Ft2-F)			Solar Heat Gain Coefficient (SHGC) Grids (None / <1 / >=1)				Visible Transmittance (VT) Grids (None / <1 / >=1)		Condensation Resistance (CR)		
331	Inswing w/ Kickplate - 1 Vertical TDL: SN 7037 / Arg / Clr - 27mm(6mm-5mm)											
	0.230	0.630	0.185					ARG90	0.022(#2)	CL	A1-D	T
	U-Factor 0.44			SHGC (>1) 0.18				VT (>1) 0.33		CR 46		
332	Inswing w/ Kickplate - 1 Vertical TDL: ClimaGuard Neutral 70 / Arg / Clr - 27mm(6mm-5mm)											
	0.226	0.630	0.185					ARG90	0.171(#2)	CL	A1-D	T
	U-Factor 0.47			SHGC (>1) 0.27				VT (>1) 0.32		CR 46		
333	Inswing w/ Kickplate - 1 Vertical TDL: SNX 6227 / Arg / Clr - 24mm(4mm-4mm)											
	0.151	0.630	0.154					ARG90	0.020(#2)	CL	A1-D	T
	U-Factor 0.44			SHGC (>1) 0.14				VT (>1) 0.30		CR 47		
334	Inswing w/ Kickplate - 1 Vertical TDL: ClimaGuard Premium T / Arg / Clr - 24mm(4mm-4mm)											
	0.151	0.630	0.154					ARG90	0.035(#2)	CL	A1-D	T
	U-Factor 0.44			SHGC (>1) 0.26				VT (>1) 0.36		CR 47		
335	Inswing w/ Kickplate - 1 Vertical TDL: SN 4023 / Arg / Clr - 24mm(4mm-4mm)											
	0.151	0.630	0.154					ARG90	0.026(#2)	CL	A1-D	T
	U-Factor 0.44			SHGC (>1) 0.12				VT (>1) 0.19		CR 47		
336	Inswing w/ Kickplate - 1 Vertical TDL: SN 5128 / Arg / Clr - 24mm(4mm-4mm)											
	0.151	0.630	0.154					ARG90	0.025(#2)	CL	A1-D	T
	U-Factor 0.44			SHGC (>1) 0.14				VT (>1) 0.24		CR 47		
337	Inswing w/ Kickplate - 1 Vertical TDL: SN 6234 / Arg / Clr - 24mm(4mm-4mm)											
	0.151	0.630	0.154					ARG90	0.026(#2)	CL	A1-D	T
	U-Factor 0.44			SHGC (>1) 0.16				VT (>1) 0.30		CR 47		
338	Inswing w/ Kickplate - 1 Vertical TDL: SN 7037 / Arg / Clr - 24mm(4mm-4mm)											
	0.151	0.630	0.154					ARG90	0.022(#2)	CL	A1-D	T
	U-Factor 0.44			SHGC (>1) 0.18				VT (>1) 0.33		CR 47		
339	Inswing w/ Kickplate - 1 Vertical TDL: ClimaGuard Neutral 70 / Arg / Clr - 24mm(4mm-4mm)											
	0.148	0.630	0.154					ARG90	0.171(#2)	CL	A1-D	T
	U-Factor 0.47			SHGC (>1) 0.28				VT (>1) 0.32		CR 46		
340	Inswing w/ Kickplate - 1 Vertical TDL: ClimaGuard Neutral 70 / Arg / Clr - 28mm(6mm-5mm)											
	0.226	0.670	0.185					ARG90	0.171(#2)	CL	A1-D	T
	U-Factor 0.47			SHGC (>1) 0.27				VT (>1) 0.32		CR 46		

TEST REPORT FOR NEON ENERGY USA INC.

Report No: K0461.02-301-45 R3

Date: 12/18/20

SECTION 6 (Continued)

SIMULATION RESULTS

TOTAL PRODUCT CALCULATIONS (Ultra Outswing and Inswing Door)												
Option Number	Pane Thickness 1 (in)	Gap Width 1 (in)	Pane Thickness 2 (in)	Gap Width 2 (in)	Pane Thickness 3 (in)	Gap Width 3 (in)	Pane Thickness 4 (in)	Gap Fill	Low-e (Surface #)	Tint	Spacer	Grid Type
	U-Factor (Btu/Hr-Ft2-F)			Solar Heat Gain Coefficient (SHGC) Grids (None / <1 / >=1)				Visible Transmittance (VT) Grids (None / <1 / >=1)		Condensation Resistance (CR)		
341	Inswing w/ Kickplate - 1 Vertical TDL: ClimaGuard Neutral 70 / Arg / Clr - 28mm(4mm-4mm)											
	0.226	0.787	0.185					ARG90	0.171(#2)	CL	A1-D	T
	U-Factor 0.48			SHGC (>1) 0.27				VT (>1) 0.32		CR 45		
342	Inswing w/ Kickplate - 1 Vertical TDL: SNX 5123 / Arg / 3mmClr-030PVB-3mmIS20 - 28mm (6mm-6mm)											
	0.221	0.625	0.264					ARG90	0.021(#2) / 0.198(#4)	CL	TS-D	T
	U-Factor 0.39			SHGC (>1) 0.12				VT (>1) 0.23		CR 48		
343	Inswing w/ Kickplate - 2 Vertical TDLs: SNX 5123 / Arg / Clr - 28mm(6mm-6mm)											
	0.221	0.630	0.224					ARG90	0.021(#2)	CL	A1-D	T
	U-Factor 0.48			SHGC (>1) 0.12				VT (>1) 0.24		CR 46		
344	Inswing w/ Kickplate - 2 Vertical TDLs: SNX 6227 / Arg / Clr - 28mm(6mm-6mm)											
	0.221	0.630	0.224					ARG90	0.020(#2)	CL	A1-D	T
	U-Factor 0.48			SHGC (>1) 0.14				VT (>1) 0.29		CR 46		
345	Inswing w/ Kickplate - 2 Vertical TDLs: ClimaGuard Premium T / Arg / Clr - 27mm(6mm-5mm)											
	0.230	0.630	0.185					ARG90	0.035(#2)	CL	A1-D	T
	U-Factor 0.48			SHGC (>1) 0.26				VT (>1) 0.36		CR 46		
346	Inswing w/ Kickplate - 2 Vertical TDLs: SN 4023 / Arg / Clr - 27mm(6mm-5mm)											
	0.230	0.630	0.185					ARG90	0.026(#2)	CL	A1-D	T
	U-Factor 0.48			SHGC (>1) 0.12				VT (>1) 0.19		CR 46		
347	Inswing w/ Kickplate - 2 Vertical TDLs: SN 5128 / Arg / Clr - 27mm(6mm-5mm)											
	0.230	0.630	0.185					ARG90	0.025(#2)	CL	A1-D	T
	U-Factor 0.48			SHGC (>1) 0.14				VT (>1) 0.24		CR 46		
348	Inswing w/ Kickplate - 2 Vertical TDLs: SN 6234 / Arg / Clr - 27mm(6mm-5mm)											
	0.230	0.630	0.185					ARG90	0.026(#2)	CL	A1-D	T
	U-Factor 0.48			SHGC (>1) 0.16				VT (>1) 0.29		CR 46		
349	Inswing w/ Kickplate - 2 Vertical TDLs: SN 7037 / Arg / Clr - 27mm(6mm-5mm)											
	0.230	0.630	0.185					ARG90	0.022(#2)	CL	A1-D	T
	U-Factor 0.48			SHGC (>1) 0.18				VT (>1) 0.33		CR 46		
350	Inswing w/ Kickplate - 2 Vertical TDLs: ClimaGuard Neutral 70 / Arg / Clr - 27mm(6mm-5mm)											
	0.226	0.630	0.185					ARG90	0.171(#2)	CL	A1-D	T
	U-Factor 0.50			SHGC (>1) 0.27				VT (>1) 0.32		CR 46		

TEST REPORT FOR NEON ENERGY USA INC.

Report No: K0461.02-301-45 R3

Date: 12/18/20

SECTION 6 (Continued)

SIMULATION RESULTS

TOTAL PRODUCT CALCULATIONS (Ultra Outswing and Inswing Door)												
Option Number	Pane Thickness 1 (in)	Gap Width 1 (in)	Pane Thickness 2 (in)	Gap Width 2 (in)	Pane Thickness 3 (in)	Gap Width 3 (in)	Pane Thickness 4 (in)	Gap Fill	Low-e (Surface #)	Tint	Spacer	Grid Type
	U-Factor (Btu/Hr-Ft2-F)			Solar Heat Gain Coefficient (SHGC) Grids (None / <1 / >=1)				Visible Transmittance (VT) Grids (None / <1 / >=1)		Condensation Resistance (CR)		
351	Inswing w/ Kickplate - 2 Vertical TDs: SNX 6227 / Arg / Clr - 24mm(4mm-4mm)											
	0.151	0.630	0.154					ARG90	0.020(#2)	CL	A1-D	T
	U-Factor 0.48			SHGC (>1) 0.14				VT (>1) 0.30		CR 47		
352	Inswing w/ Kickplate - 2 Vertical TDs: ClimaGuard Premium T / Arg / Clr - 24mm(4mm-4mm)											
	0.151	0.630	0.154					ARG90	0.035(#2)	CL	A1-D	T
	U-Factor 0.48			SHGC (>1) 0.26				VT (>1) 0.36		CR 47		
353	Inswing w/ Kickplate - 2 Vertical TDs: SN 4023 / Arg / Clr - 24mm(4mm-4mm)											
	0.151	0.630	0.154					ARG90	0.026(#2)	CL	A1-D	T
	U-Factor 0.48			SHGC (>1) 0.12				VT (>1) 0.19		CR 47		
354	Inswing w/ Kickplate - 2 Vertical TDs: SN 5128 / Arg / Clr - 24mm(4mm-4mm)											
	0.151	0.630	0.154					ARG90	0.025(#2)	CL	A1-D	T
	U-Factor 0.48			SHGC (>1) 0.14				VT (>1) 0.24		CR 47		
355	Inswing w/ Kickplate - 2 Vertical TDs: SN 6234 / Arg / Clr - 24mm(4mm-4mm)											
	0.151	0.630	0.154					ARG90	0.026(#2)	CL	A1-D	T
	U-Factor 0.48			SHGC (>1) 0.16				VT (>1) 0.30		CR 47		
356	Inswing w/ Kickplate - 2 Vertical TDs: SN 7037 / Arg / Clr - 24mm(4mm-4mm)											
	0.151	0.630	0.154					ARG90	0.022(#2)	CL	A1-D	T
	U-Factor 0.48			SHGC (>1) 0.18				VT (>1) 0.33		CR 47		
357	Inswing w/ Kickplate - 2 Vertical TDs: ClimaGuard Neutral 70 / Arg / Clr - 24mm(4mm-4mm)											
	0.148	0.630	0.154					ARG90	0.171(#2)	CL	A1-D	T
	U-Factor 0.50			SHGC (>1) 0.28				VT (>1) 0.32		CR 46		
358	Inswing w/ Kickplate - 2 Vertical TDs: ClimaGuard Neutral 70 / Arg / Clr - 28mm(6mm-5mm)											
	0.226	0.670	0.185					ARG90	0.171(#2)	CL	A1-D	T
	U-Factor 0.51			SHGC (>1) 0.27				VT (>1) 0.32		CR 46		
359	Inswing w/ Kickplate - 2 Vertical TDs: ClimaGuard Neutral 70 / Arg / Clr - 28mm(4mm-4mm)											
	0.226	0.787	0.185					ARG90	0.171(#2)	CL	A1-D	T
	U-Factor 0.51			SHGC (>1) 0.27				VT (>1) 0.32		CR 45		
360	Inswing w/ Kickplate - 2 Vertical TDs: SNX 5123 / Arg / 3mmClr-030PVB-3mmIS20 - 28mm (6mm-6mm)											
	0.221	0.625	0.264					ARG90	0.021(#2) / 0.198(#4)	CL	TS-D	T
	U-Factor 0.41			SHGC (>1) 0.12				VT (>1) 0.23		CR 48		

TEST REPORT FOR NEON ENERGY USA INC.

Report No: K0461.02-301-45 R3

Date: 12/18/20

SECTION 6 (Continued) SIMULATION RESULTS

TOTAL PRODUCT CALCULATIONS (Ultra Outswing and Inswing Door)												
Option Number	Pane Thickness 1 (in)	Gap Width 1 (in)	Pane Thickness 2 (in)	Gap Width 2 (in)	Pane Thickness 3 (in)	Gap Width 3 (in)	Pane Thickness 4 (in)	Gap Fill	Low-e (Surface #)	Tint	Spacer	Grid Type
	U-Factor (Btu/Hr-Ft2-F)			Solar Heat Gain Coefficient (SHGC) Grids (None / <1 / >=1)				Visible Transmittance (VT) Grids (None / <1 / >=1)		Condensation Resistance (CR)		
361	Inswing w/ Kickplate - 3 Vertical TDLS: SNX 5123 / Arg / Clr - 28mm(6mm-6mm)											
	0.221	0.630	0.224					ARG90	0.021(#2)	CL	A1-D	T
	U-Factor 0.52			SHGC (>1) 0.12				VT (>1) 0.24		CR 46		
362	Inswing w/ Kickplate - 3 Vertical TDLS: SNX 6227 / Arg / Clr - 28mm(6mm-6mm)											
	0.221	0.630	0.224					ARG90	0.020(#2)	CL	A1-D	T
	U-Factor 0.52			SHGC (>1) 0.14				VT (>1) 0.29		CR 46		
363	Inswing w/ Kickplate - 3 Vertical TDLS: ClimaGuard Premium T / Arg / Clr - 27mm(6mm-5mm)											
	0.230	0.630	0.185					ARG90	0.035(#2)	CL	A1-D	T
	U-Factor 0.52			SHGC (>1) 0.26				VT (>1) 0.36		CR 46		
364	Inswing w/ Kickplate - 3 Vertical TDLS: SN 4023 / Arg / Clr - 27mm(6mm-5mm)											
	0.230	0.630	0.185					ARG90	0.026(#2)	CL	A1-D	T
	U-Factor 0.52			SHGC (>1) 0.12				VT (>1) 0.19		CR 46		
365	Inswing w/ Kickplate - 3 Vertical TDLS: SN 5128 / Arg / Clr - 27mm(6mm-5mm)											
	0.230	0.630	0.185					ARG90	0.025(#2)	CL	A1-D	T
	U-Factor 0.52			SHGC (>1) 0.14				VT (>1) 0.24		CR 46		
366	Inswing w/ Kickplate - 3 Vertical TDLS: SN 6234 / Arg / Clr - 27mm(6mm-5mm)											
	0.230	0.630	0.185					ARG90	0.026(#2)	CL	A1-D	T
	U-Factor 0.52			SHGC (>1) 0.16				VT (>1) 0.29		CR 46		
367	Inswing w/ Kickplate - 3 Vertical TDLS: SN 7037 / Arg / Clr - 27mm(6mm-5mm)											
	0.230	0.630	0.185					ARG90	0.022(#2)	CL	A1-D	T
	U-Factor 0.52			SHGC (>1) 0.18				VT (>1) 0.33		CR 46		
368	Inswing w/ Kickplate - 3 Vertical TDLS: ClimaGuard Neutral 70 / Arg / Clr - 27mm(6mm-5mm)											
	0.226	0.630	0.185					ARG90	0.171(#2)	CL	A1-D	T
	U-Factor 0.54			SHGC (>1) 0.27				VT (>1) 0.32		CR 46		
369	Inswing w/ Kickplate - 3 Vertical TDLS: SNX 6227 / Arg / Clr - 24mm(4mm-4mm)											
	0.151	0.630	0.154					ARG90	0.020(#2)	CL	A1-D	T
	U-Factor 0.51			SHGC (>1) 0.14				VT (>1) 0.30		CR 47		
370	Inswing w/ Kickplate - 3 Vertical TDLS: ClimaGuard Premium T / Arg / Clr - 24mm(4mm-4mm)											
	0.151	0.630	0.154					ARG90	0.035(#2)	CL	A1-D	T
	U-Factor 0.51			SHGC (>1) 0.26				VT (>1) 0.36		CR 47		

TEST REPORT FOR NEON ENERGY USA INC.

Report No: K0461.02-301-45 R3

Date: 12/18/20

SECTION 6 (Continued)

SIMULATION RESULTS

TOTAL PRODUCT CALCULATIONS (Ultra Outswing and Inswing Door)												
Option Number	Pane Thickness 1 (in)	Gap Width 1 (in)	Pane Thickness 2 (in)	Gap Width 2 (in)	Pane Thickness 3 (in)	Gap Width 3 (in)	Pane Thickness 4 (in)	Gap Fill	Low-e (Surface #)	Tint	Spacer	Grid Type
	U-Factor (Btu/Hr-Ft2-F)			Solar Heat Gain Coefficient (SHGC) Grids (None / <1 / >=1)				Visible Transmittance (VT) Grids (None / <1 / >=1)		Condensation Resistance (CR)		
371	Inswing w/ Kickplate - 3 Vertical TDLS: SN 4023 / Arg / Clr - 24mm(4mm-4mm)											
	0.151	0.630	0.154					ARG90	0.026(#2)	CL	A1-D	T
	U-Factor 0.51			SHGC (>1) 0.12				VT (>1) 0.19		CR 47		
372	Inswing w/ Kickplate - 3 Vertical TDLS: SN 5128 / Arg / Clr - 24mm(4mm-4mm)											
	0.151	0.630	0.154					ARG90	0.025(#2)	CL	A1-D	T
	U-Factor 0.51			SHGC (>1) 0.14				VT (>1) 0.24		CR 47		
373	Inswing w/ Kickplate - 3 Vertical TDLS: SN 6234 / Arg / Clr - 24mm(4mm-4mm)											
	0.151	0.630	0.154					ARG90	0.026(#2)	CL	A1-D	T
	U-Factor 0.51			SHGC (>1) 0.16				VT (>1) 0.30		CR 47		
374	Inswing w/ Kickplate - 3 Vertical TDLS: SN 7037 / Arg / Clr - 24mm(4mm-4mm)											
	0.151	0.630	0.154					ARG90	0.022(#2)	CL	A1-D	T
	U-Factor 0.51			SHGC (>1) 0.18				VT (>1) 0.33		CR 47		
375	Inswing w/ Kickplate - 3 Vertical TDLS: ClimaGuard Neutral 70 / Arg / Clr - 24mm(4mm-4mm)											
	0.148	0.630	0.154					ARG90	0.171(#2)	CL	A1-D	T
	U-Factor 0.53			SHGC (>1) 0.28				VT (>1) 0.32		CR 46		
376	Inswing w/ Kickplate - 3 Vertical TDLS: ClimaGuard Neutral 70 / Arg / Clr - 28mm(6mm-5mm)											
	0.226	0.670	0.185					ARG90	0.171(#2)	CL	A1-D	T
	U-Factor 0.54			SHGC (>1) 0.27				VT (>1) 0.32		CR 46		
377	Inswing w/ Kickplate - 3 Vertical TDLS: ClimaGuard Neutral 70 / Arg / Clr - 28mm(4mm-4mm)											
	0.226	0.787	0.185					ARG90	0.171(#2)	CL	A1-D	T
	U-Factor 0.55			SHGC (>1) 0.27				VT (>1) 0.32		CR 45		
378	Inswing w/ Kickplate - 3 Vertical TDLS: SNX 5123 / Arg / 3mmClr-030PVB-3mmIS20 - 28mm (6mm-6mm)											
	0.221	0.625	0.264					ARG90	0.021(#2) / 0.198(#4)	CL	TS-D	T
	U-Factor 0.43			SHGC (>1) 0.12				VT (>1) 0.23		CR 48		
379	Inswing w/ Kickplate - 4 Vertical TDLS: SNX 5123 / Arg / Clr - 28mm(6mm-6mm)											
	0.221	0.630	0.224					ARG90	0.021(#2)	CL	A1-D	T
	U-Factor 0.58			SHGC (>1) 0.12				VT (>1) 0.24		CR 46		
380	Inswing w/ Kickplate - 4 Vertical TDLS: SNX 6227 / Arg / Clr - 28mm(6mm-6mm)											
	0.221	0.630	0.224					ARG90	0.020(#2)	CL	A1-D	T
	U-Factor 0.58			SHGC (>1) 0.14				VT (>1) 0.29		CR 46		

TEST REPORT FOR NEON ENERGY USA INC.

Report No: K0461.02-301-45 R3

Date: 12/18/20

SECTION 6 (Continued)

SIMULATION RESULTS

TOTAL PRODUCT CALCULATIONS (Ultra Outswing and Inswing Door)												
Option Number	Pane Thickness 1 (in)	Gap Width 1 (in)	Pane Thickness 2 (in)	Gap Width 2 (in)	Pane Thickness 3 (in)	Gap Width 3 (in)	Pane Thickness 4 (in)	Gap Fill	Low-e (Surface #)	Tint	Spacer	Grid Type
	U-Factor (Btu/Hr-Ft2-F)			Solar Heat Gain Coefficient (SHGC) Grids (None / <1 / >=1)				Visible Transmittance (VT) Grids (None / <1 / >=1)		Condensation Resistance (CR)		
381	Inswing w/ Kickplate - 4 Vertical TDLS: ClimaGuard Premium T / Arg / Clr - 27mm(6mm-5mm)											
	0.230	0.630	0.185					ARG90	0.035(#2)	CL	A1-D	T
	U-Factor 0.58			SHGC (>1) 0.26				VT (>1) 0.36		CR 46		
382	Inswing w/ Kickplate - 4 Vertical TDLS: SN 4023 / Arg / Clr - 27mm(6mm-5mm)											
	0.230	0.630	0.185					ARG90	0.026(#2)	CL	A1-D	T
	U-Factor 0.58			SHGC (>1) 0.12				VT (>1) 0.19		CR 46		
383	Inswing w/ Kickplate - 4 Vertical TDLS: SN 5128 / Arg / Clr - 27mm(6mm-5mm)											
	0.230	0.630	0.185					ARG90	0.025(#2)	CL	A1-D	T
	U-Factor 0.58			SHGC (>1) 0.14				VT (>1) 0.24		CR 46		
384	Inswing w/ Kickplate - 4 Vertical TDLS: SN 6234 / Arg / Clr - 27mm(6mm-5mm)											
	0.230	0.630	0.185					ARG90	0.026(#2)	CL	A1-D	T
	U-Factor 0.58			SHGC (>1) 0.16				VT (>1) 0.29		CR 46		
385	Inswing w/ Kickplate - 4 Vertical TDLS: SN 7037 / Arg / Clr - 27mm(6mm-5mm)											
	0.230	0.630	0.185					ARG90	0.022(#2)	CL	A1-D	T
	U-Factor 0.58			SHGC (>1) 0.18				VT (>1) 0.33		CR 46		
386	Inswing w/ Kickplate - 4 Vertical TDLS: ClimaGuard Neutral 70 / Arg / Clr - 27mm(6mm-5mm)											
	0.226	0.630	0.185					ARG90	0.171(#2)	CL	A1-D	T
	U-Factor 0.60			SHGC (>1) 0.27				VT (>1) 0.32		CR 46		
387	Inswing w/ Kickplate - 4 Vertical TDLS: SNX 6227 / Arg / Clr - 24mm(4mm-4mm)											
	0.151	0.630	0.154					ARG90	0.020(#2)	CL	A1-D	T
	U-Factor 0.57			SHGC (>1) 0.14				VT (>1) 0.30		CR 47		
388	Inswing w/ Kickplate - 4 Vertical TDLS: ClimaGuard Premium T / Arg / Clr - 24mm(4mm-4mm)											
	0.151	0.630	0.154					ARG90	0.035(#2)	CL	A1-D	T
	U-Factor 0.57			SHGC (>1) 0.26				VT (>1) 0.36		CR 47		
389	Inswing w/ Kickplate - 4 Vertical TDLS: SN 4023 / Arg / Clr - 24mm(4mm-4mm)											
	0.151	0.630	0.154					ARG90	0.026(#2)	CL	A1-D	T
	U-Factor 0.57			SHGC (>1) 0.12				VT (>1) 0.19		CR 47		
390	Inswing w/ Kickplate - 4 Vertical TDLS: SN 5128 / Arg / Clr - 24mm(4mm-4mm)											
	0.151	0.630	0.154					ARG90	0.025(#2)	CL	A1-D	T
	U-Factor 0.57			SHGC (>1) 0.14				VT (>1) 0.24		CR 47		

TEST REPORT FOR NEON ENERGY USA INC.

Report No: K0461.02-301-45 R3

Date: 12/18/20

SECTION 6 (Continued)

SIMULATION RESULTS

TOTAL PRODUCT CALCULATIONS (Ultra Outswing and Inswing Door)												
Option Number	Pane Thickness 1 (in)	Gap Width 1 (in)	Pane Thickness 2 (in)	Gap Width 2 (in)	Pane Thickness 3 (in)	Gap Width 3 (in)	Pane Thickness 4 (in)	Gap Fill	Low-e (Surface #)	Tint	Spacer	Grid Type
	U-Factor (Btu/Hr-Ft2-F)			Solar Heat Gain Coefficient (SHGC) Grids (None / <1 / >=1)				Visible Transmittance (VT) Grids (None / <1 / >=1)		Condensation Resistance (CR)		
391	Inswing w/ Kickplate - 4 Vertical TDLs: SN 6234 / Arg / Clr - 24mm(4mm-4mm)											
	0.151	0.630	0.154					ARG90	0.026(#2)	CL	A1-D	T
	U-Factor 0.57			SHGC (>1) 0.16				VT (>1) 0.30		CR 47		
392	Inswing w/ Kickplate - 4 Vertical TDLs: SN 7037 / Arg / Clr - 24mm(4mm-4mm)											
	0.151	0.630	0.154					ARG90	0.022(#2)	CL	A1-D	T
	U-Factor 0.57			SHGC (>1) 0.18				VT (>1) 0.33		CR 47		
393	Inswing w/ Kickplate - 4 Vertical TDLs: ClimaGuard Neutral 70 / Arg / Clr - 24mm(4mm-4mm)											
	0.148	0.630	0.154					ARG90	0.171(#2)	CL	A1-D	T
	U-Factor 0.59			SHGC (>1) 0.28				VT (>1) 0.32		CR 46		
394	Inswing w/ Kickplate - 4 Vertical TDLs: ClimaGuard Neutral 70 / Arg / Clr - 28mm(6mm-5mm)											
	0.226	0.670	0.185					ARG90	0.171(#2)	CL	A1-D	T
	U-Factor 0.60			SHGC (>1) 0.27				VT (>1) 0.32		CR 46		
395	Inswing w/ Kickplate - 4 Vertical TDLs: ClimaGuard Neutral 70 / Arg / Clr - 28mm(4mm-4mm)											
	0.226	0.787	0.185					ARG90	0.171(#2)	CL	A1-D	T
	U-Factor 0.62			SHGC (>1) 0.27				VT (>1) 0.32		CR 45		
396	Inswing w/ Kickplate - 4 Vertical TDLs: SNX 5123 / Arg / 3mmClr-030PVB-3mmIS20 - 28mm (6mm-6mm)											
	0.221	0.625	0.264					ARG90	0.021(#2) / 0.198(#4)	CL	TS-D	T
	U-Factor 0.48			SHGC (>1) 0.12				VT (>1) 0.23		CR 48		
397	Inswing w/ Kickplate: SN 5128 / Arg / Climaguard Dry - 27mm(6mm-6mm)											
	0.230	0.590	0.230					ARG90	0.025(#2) / 0.200(#4)	CL	TP-D	N
	U-Factor 0.36			SHGC (N) 0.17				VT (N) 0.32		CR 48		
398	Inswing w/ Kickplate - SN 5128 / Arg / ClimaGurad Dry - 27mm(6mm-6mm): SN 5128 / Arg / Climaguard Dry - 27mm(6mm-6mm)											
	0.230	0.590	0.230					ARG90	0.025(#2) / 0.200(#4)	CL	TP-D	T
	U-Factor 0.46			SHGC (>1) 0.13				VT (>1) 0.23		CR 48		
399	Inswing w/ Kickplate - 1 Horizontal TDL: SN 5128 / Arg / Climaguard Dry - 27mm(6mm-6mm)											
	0.230	0.590	0.230					ARG90	0.025(#2) / 0.200(#4)	CL	TP-D	T
	U-Factor 0.37			SHGC (>1) 0.13				VT (>1) 0.23		CR 48		
400	Inswing w/ Kickplate - 2 Horizontal TDLs: SN 5128 / Arg / Climaguard Dry - 27mm(6mm-6mm)											
	0.230	0.590	0.230					ARG90	0.025(#2) / 0.200(#4)	CL	TP-D	T
	U-Factor 0.38			SHGC (>1) 0.13				VT (>1) 0.23		CR 48		

TEST REPORT FOR NEON ENERGY USA INC.

Report No: K0461.02-301-45 R3

Date: 12/18/20

SECTION 6 (Continued)

SIMULATION RESULTS

TOTAL PRODUCT CALCULATIONS (Ultra Outswing and Inswing Door)												
Option Number	Pane Thickness 1 (in)	Gap Width 1 (in)	Pane Thickness 2 (in)	Gap Width 2 (in)	Pane Thickness 3 (in)	Gap Width 3 (in)	Pane Thickness 4 (in)	Gap Fill	Low-e (Surface #)	Tint	Spacer	Grid Type
	U-Factor (Btu/Hr-Ft2-F)			Solar Heat Gain Coefficient (SHGC) Grids (None / <1 / >=1)				Visible Transmittance (VT) Grids (None / <1 / >=1)		Condensation Resistance (CR)		
401	Inswing w/ Kickplate - 3 Horizontal TDLS: SN 5128 / Arg / Climaguard Dry - 27mm(6mm-6mm)											
	0.230	0.590	0.230					ARG90	0.025(#2) / 0.200(#4)	CL	TP-D	T
	U-Factor 0.38			SHGC (>1) 0.13				VT (>1) 0.23		CR 48		
402	Inswing w/ Kickplate - 4 Horizontal TDLS: SN 5128 / Arg / Climaguard Dry - 27mm(6mm-6mm)											
	0.230	0.590	0.230					ARG90	0.025(#2) / 0.200(#4)	CL	TP-D	T
	U-Factor 0.39			SHGC (>1) 0.13				VT (>1) 0.23		CR 48		
403	Inswing w/ Kickplate - 1 Vertical TDLS: SN 5128 / Arg / Climaguard Dry - 27mm(6mm-6mm)											
	0.230	0.590	0.230					ARG90	0.025(#2) / 0.200(#4)	CL	TP-D	T
	U-Factor 0.38			SHGC (>1) 0.13				VT (>1) 0.23		CR 48		
404	Inswing w/ Kickplate - 2 Vertical TDLS: SN 5128 / Arg / Climaguard Dry - 27mm(6mm-6mm)											
	0.230	0.590	0.230					ARG90	0.025(#2) / 0.200(#4)	CL	TP-D	T
	U-Factor 0.40			SHGC (>1) 0.13				VT (>1) 0.23		CR 48		
405	Inswing w/ Kickplate - 3 Vertical TDLS: SN 5128 / Arg / Climaguard Dry - 27mm(6mm-6mm)											
	0.230	0.590	0.230					ARG90	0.025(#2) / 0.200(#4)	CL	TP-D	T
	U-Factor 0.42			SHGC (>1) 0.13				VT (>1) 0.23		CR 48		
406	Inswing w/ Kickplate - 4 Vertical TDLS: SN 5128 / Arg / Climaguard Dry - 27mm(6mm-6mm)											
	0.230	0.590	0.230					ARG90	0.025(#2) / 0.200(#4)	CL	TP-D	T
	U-Factor 0.46			SHGC (>1) 0.13				VT (>1) 0.23		CR 48		
407	Inswing w/ Kickplate: SN 5128 / Arg / IS20 - 27mm(6mm-6mm)											
	0.230	0.590	0.221					ARG90	0.025(#2) / 0.198(#4)	CL	TP-D	N
	U-Factor 0.36			SHGC (N) 0.17				VT (N) 0.31		CR 49		
408	Inswing w/ Kickplate - SN 5128 / Arg / IS20 - 27mm(6mm-6mm): SN 5128 / Arg / IS20 - 27mm(6mm-6mm)											
	0.230	0.590	0.221					ARG90	0.025(#2) / 0.198(#4)	CL	TP-D	T
	U-Factor 0.46			SHGC (>1) 0.13				VT (>1) 0.23		CR 49		
409	Inswing w/ Kickplate - 1 Horizontal TDLS: SN 5128 / Arg / IS20 - 27mm(6mm-6mm)											
	0.230	0.590	0.221					ARG90	0.025(#2) / 0.198(#4)	CL	TP-D	T
	U-Factor 0.37			SHGC (>1) 0.13				VT (>1) 0.23		CR 49		
410	Inswing w/ Kickplate - 2 Horizontal TDLS: SN 5128 / Arg / IS20 - 27mm(6mm-6mm)											
	0.230	0.590	0.221					ARG90	0.025(#2) / 0.198(#4)	CL	TP-D	T
	U-Factor 0.38			SHGC (>1) 0.13				VT (>1) 0.23		CR 49		

TEST REPORT FOR NEON ENERGY USA INC.

Report No: K0461.02-301-45 R3

Date: 12/18/20

SECTION 6 (Continued)

SIMULATION RESULTS

TOTAL PRODUCT CALCULATIONS (Ultra Outswing and Inswing Door)												
Option Number	Pane Thickness 1 (in)	Gap Width 1 (in)	Pane Thickness 2 (in)	Gap Width 2 (in)	Pane Thickness 3 (in)	Gap Width 3 (in)	Pane Thickness 4 (in)	Gap Fill	Low-e (Surface #)	Tint	Spacer	Grid Type
	U-Factor (Btu/Hr-Ft ² -F)			Solar Heat Gain Coefficient (SHGC) Grids (None / <1 / >=1)				Visible Transmittance (VT) Grids (None / <1 / >=1)		Condensation Resistance (CR)		
411	Inswing w/ Kickplate - 3 Horizontal TDLS: SN 5128 / Arg / IS20 - 27mm(6mm-6mm)											
	0.230	0.590	0.221					ARG90	0.025(#2) / 0.198(#4)	CL	TP-D	T
	U-Factor 0.38			SHGC (>1) 0.13				VT (>1) 0.23		CR 49		
412	Inswing w/ Kickplate - 4 Horizontal TDLS: SN 5128 / Arg / IS20 - 27mm(6mm-6mm)											
	0.230	0.590	0.221					ARG90	0.025(#2) / 0.198(#4)	CL	TP-D	T
	U-Factor 0.39			SHGC (>1) 0.13				VT (>1) 0.23		CR 49		
413	Inswing w/ Kickplate - 1 Vertical TDLS: SN 5128 / Arg / IS20 - 27mm(6mm-6mm)											
	0.230	0.590	0.221					ARG90	0.025(#2) / 0.198(#4)	CL	TP-D	T
	U-Factor 0.38			SHGC (>1) 0.13				VT (>1) 0.23		CR 49		
414	Inswing w/ Kickplate - 2 Vertical TDLS: SN 5128 / Arg / IS20 - 27mm(6mm-6mm)											
	0.230	0.590	0.221					ARG90	0.025(#2) / 0.198(#4)	CL	TP-D	T
	U-Factor 0.40			SHGC (>1) 0.13				VT (>1) 0.23		CR 49		
415	Inswing w/ Kickplate - 3 Vertical TDLS: SN 5128 / Arg / IS20 - 27mm(6mm-6mm)											
	0.230	0.590	0.221					ARG90	0.025(#2) / 0.198(#4)	CL	TP-D	T
	U-Factor 0.42			SHGC (>1) 0.13				VT (>1) 0.23		CR 49		
416	Inswing w/ Kickplate - 4 Vertical TDLS: SN 5128 / Arg / IS20 - 27mm(6mm-6mm)											
	0.230	0.590	0.221					ARG90	0.025(#2) / 0.198(#4)	CL	TP-D	T
	U-Factor 0.46			SHGC (>1) 0.13				VT (>1) 0.23		CR 49		
417	Inswing w/ Kickplate: 4mm-076PVB-4mmPlanistar / Arg / 3mmClr-076PVB-3mmClr - 28mm(8mm-6mm)											
	0.384	0.391	0.311					ARG90	0.026(#2)	CL	A1-D	N
	U-Factor 0.40			SHGC (N) 0.22				VT (N) 0.44		CR 47		
418	Inswing w/ Kickplate - 4mm-076PVB-4mmPlanistar / Arg / 3mmClr-076PVB-3mmClr - 28mm(8mm-6mm); 4mm-076PVB-4mmPlanistar / Arg / 3mmClr-076PVB-3mmClr - 28mm(8mm-6mm)											
	0.384	0.391	0.311					ARG90	0.026(#2)	CL	A1-D	T
	U-Factor 0.54			SHGC (>1) 0.17				VT (>1) 0.32		CR 47		
419	Inswing w/ Kickplate - 1 Horizontal TDLS: 4mm-076PVB-4mmPlanistar / Arg / 3mmClr-076PVB-3mmClr - 28mm(8mm-6mm)											
	0.384	0.391	0.311					ARG90	0.026(#2)	CL	A1-D	T
	U-Factor 0.41			SHGC (>1) 0.17				VT (>1) 0.32		CR 47		
420	Inswing w/ Kickplate - 2 Horizontal TDLS: 4mm-076PVB-4mmPlanistar / Arg / 3mmClr-076PVB-3mmClr - 28mm(8mm-6mm)											
	0.384	0.391	0.311					ARG90	0.026(#2)	CL	A1-D	T
	U-Factor 0.42			SHGC (>1) 0.17				VT (>1) 0.32		CR 47		

TEST REPORT FOR NEON ENERGY USA INC.

Report No: K0461.02-301-45 R3

Date: 12/18/20

SECTION 6 (Continued)

SIMULATION RESULTS

TOTAL PRODUCT CALCULATIONS (Ultra Outswing and Inswing Door)												
Option Number	Pane Thickness 1 (in)	Gap Width 1 (in)	Pane Thickness 2 (in)	Gap Width 2 (in)	Pane Thickness 3 (in)	Gap Width 3 (in)	Pane Thickness 4 (in)	Gap Fill	Low-e (Surface #)	Tint	Spacer	Grid Type
	U-Factor (Btu/Hr-Ft ² -F)			Solar Heat Gain Coefficient (SHGC) Grids (None / <1 / >=1)				Visible Transmittance (VT) Grids (None / <1 / >=1)		Condensation Resistance (CR)		
421	Inswing w/ Kickplate - 3 Horizontal TDLS: 4mm-076PVB-4mmPlanistar / Arg / 3mmClr-076PVB-3mmClr - 28mm(8mm-6mm)											
	0.384	0.391	0.311					ARG90	0.026(#2)	CL	A1-D	T
	U-Factor 0.44			SHGC (>1) 0.17				VT (>1) 0.32		CR 47		
422	Inswing w/ Kickplate - 4 Horizontal TDLS: 4mm-076PVB-4mmPlanistar / Arg / 3mmClr-076PVB-3mmClr - 28mm(8mm-6mm)											
	0.384	0.391	0.311					ARG90	0.026(#2)	CL	A1-D	T
	U-Factor 0.45			SHGC (>1) 0.17				VT (>1) 0.32		CR 47		
423	Inswing w/ Kickplate - 1 Vertical TDLS: 4mm-076PVB-4mmPlanistar / Arg / 3mmClr-076PVB-3mmClr - 28mm(8mm-6mm)											
	0.384	0.391	0.311					ARG90	0.026(#2)	CL	A1-D	T
	U-Factor 0.43			SHGC (>1) 0.17				VT (>1) 0.32		CR 47		
424	Inswing w/ Kickplate - 2 Vertical TDLS: 4mm-076PVB-4mmPlanistar / Arg / 3mmClr-076PVB-3mmClr - 28mm(8mm-6mm)											
	0.384	0.391	0.311					ARG90	0.026(#2)	CL	A1-D	T
	U-Factor 0.46			SHGC (>1) 0.17				VT (>1) 0.32		CR 47		
425	Inswing w/ Kickplate - 3 Vertical TDLS: 4mm-076PVB-4mmPlanistar / Arg / 3mmClr-076PVB-3mmClr - 28mm(8mm-6mm)											
	0.384	0.391	0.311					ARG90	0.026(#2)	CL	A1-D	T
	U-Factor 0.49			SHGC (>1) 0.17				VT (>1) 0.32		CR 47		
426	Inswing w/ Kickplate - 4 Vertical TDLS: 4mm-076PVB-4mmPlanistar / Arg / 3mmClr-076PVB-3mmClr - 28mm(8mm-6mm)											
	0.384	0.391	0.311					ARG90	0.026(#2)	CL	A1-D	T
	U-Factor 0.55			SHGC (>1) 0.17				VT (>1) 0.32		CR 47		
427	Outswing: SNX 5123 / Arg / Clr - 28mm(6mm-6mm)											
	0.221	0.630	0.224					ARG90	0.021(#2)	CL	A1-D	N
	U-Factor 0.39			SHGC(N) 0.16				VT(N) 0.32		CR 53		
428	Outswing - NFRC Default: SNX 5123 / Arg / Clr - 28mm(6mm-6mm)											
	0.221	0.630	0.224					ARG90	0.021(#2)	CL	A1-D	T
	U-Factor 0.56			SHGC(>1) 0.12				VT(>1) 0.24		CR 47		
429	Outswing: SNX 6227 / Arg / Clr - 28mm(6mm-6mm)											
	0.221	0.630	0.224					ARG90	0.020(#2)	CL	A1-D	N
	U-Factor 0.39			SHGC(N) 0.18				VT(N) 0.39		CR 53		
430	Outswing - NFRC Default: SNX 6227 / Arg / Clr - 28mm(6mm-6mm)											
	0.221	0.630	0.224					ARG90	0.020(#2)	CL	A1-D	T
	U-Factor 0.56			SHGC(>1) 0.14				VT(>1) 0.28		CR 47		

TEST REPORT FOR NEON ENERGY USA INC.

Report No: K0461.02-301-45 R3

Date: 12/18/20

SECTION 6 (Continued)

SIMULATION RESULTS

TOTAL PRODUCT CALCULATIONS (Ultra Outswing and Inswing Door)												
Option Number	Pane Thickness 1 (in)	Gap Width 1 (in)	Pane Thickness 2 (in)	Gap Width 2 (in)	Pane Thickness 3 (in)	Gap Width 3 (in)	Pane Thickness 4 (in)	Gap Fill	Low-e (Surface #)	Tint	Spacer	Grid Type
	U-Factor (Btu/Hr-Ft2-F)			Solar Heat Gain Coefficient (SHGC) Grids (None / <1 / >=1)				Visible Transmittance (VT) Grids (None / <1 / >=1)		Condensation Resistance (CR)		
431	Outswing: ClimaGuard Premium T / Arg / Clr - 27mm(6mm-5mm)											
	0.230	0.630	0.185					ARG90	0.035(#2)	CL	A1-D	N
	U-Factor 0.40			SHGC(N) 0.33				VT(N) 0.48		CR 53		
432	Outswing - NFRC Default: ClimaGuard Premium T / Arg / Clr - 27mm(6mm-5mm)											
	0.230	0.630	0.185					ARG90	0.035(#2)	CL	A1-D	T
	U-Factor 0.56			SHGC(>1) 0.25				VT(>1) 0.35		CR 47		
433	Outswing: SN 4023 / Arg / Clr - 27mm(6mm-5mm)											
	0.230	0.630	0.185					ARG90	0.026(#2)	CL	A1-D	N
	U-Factor 0.40			SHGC(N) 0.15				VT(N) 0.25		CR 53		
434	Outswing - NFRC Default: SN 4023 / Arg / Clr - 27mm(6mm-5mm)											
	0.230	0.630	0.185					ARG90	0.026(#2)	CL	A1-D	T
	U-Factor 0.56			SHGC(>1) 0.12				VT(>1) 0.18		CR 48		
435	Outswing: SN 5128 / Arg / Clr - 27mm(6mm-5mm)											
	0.230	0.630	0.185					ARG90	0.025(#2)	CL	A1-D	N
	U-Factor 0.40			SHGC(N) 0.18				VT(N) 0.32		CR 53		
436	Outswing - NFRC Default: SN 5128 / Arg / Clr - 27mm(6mm-5mm)											
	0.230	0.630	0.185					ARG90	0.025(#2)	CL	A1-D	T
	U-Factor 0.56			SHGC(>1) 0.14				VT(>1) 0.23		CR 48		
437	Outswing: SN 6234 / Arg / Clr - 27mm(6mm-5mm)											
	0.230	0.630	0.185					ARG90	0.026(#2)	CL	A1-D	N
	U-Factor 0.40			SHGC(N) 0.21				VT(N) 0.39		CR 53		
438	Outswing - NFRC Default: SN 6234 / Arg / Clr - 27mm(6mm-5mm)											
	0.230	0.630	0.185					ARG90	0.026(#2)	CL	A1-D	T
	U-Factor 0.56			SHGC(>1) 0.16				VT(>1) 0.29		CR 48		
439	Outswing: SN 7037 / Arg / Clr - 27mm(6mm-5mm)											
	0.230	0.630	0.185					ARG90	0.022(#2)	CL	A1-D	N
	U-Factor 0.39			SHGC(N) 0.23				VT(N) 0.44		CR 53		
440	Outswing - NFRC Default: SN 7037 / Arg / Clr - 27mm(6mm-5mm)											
	0.230	0.630	0.185					ARG90	0.022(#2)	CL	A1-D	T
	U-Factor 0.56			SHGC(>1) 0.18				VT(>1) 0.32		CR 48		

TEST REPORT FOR NEON ENERGY USA INC.

Report No: K0461.02-301-45 R3

Date: 12/18/20

SECTION 6 (Continued)

SIMULATION RESULTS

TOTAL PRODUCT CALCULATIONS (Ultra Outswing and Inswing Door)												
Option Number	Pane Thickness 1 (in)	Gap Width 1 (in)	Pane Thickness 2 (in)	Gap Width 2 (in)	Pane Thickness 3 (in)	Gap Width 3 (in)	Pane Thickness 4 (in)	Gap Fill	Low-e (Surface #)	Tint	Spacer	Grid Type
	U-Factor (Btu/Hr-Ft ² -F)			Solar Heat Gain Coefficient (SHGC) Grids (None / <1 / >=1)				Visible Transmittance (VT) Grids (None / <1 / >=1)		Condensation Resistance (CR)		
441	Outswing: ClimaGuard Neutral 70 / Arg / Clr - 27mm(6mm-5mm)											
	0.226	0.630	0.185					ARG90	0.171(#2)	CL	A1-D	N
	U-Factor 0.43			SHGC(N) 0.36				VT(N) 0.43		CR 53		
442	Outswing - NFRC Default: ClimaGuard Neutral 70 / Arg / Clr - 27mm(6mm-5mm)											
	0.226	0.630	0.185					ARG90	0.171(#2)	CL	A1-D	T
	U-Factor 0.58			SHGC(>1) 0.27				VT(>1) 0.31		CR 46		
443	Outswing: SNX 6227 / Arg / Clr - 24mm(4mm-4mm)											
	0.151	0.630	0.154					ARG90	0.020(#2)	CL	A1-D	N
	U-Factor 0.40			SHGC(N) 0.18				VT(N) 0.40		CR 53		
444	Outswing - NFRC Default: SNX 6227 / Arg / Clr - 24mm(4mm-4mm)											
	0.151	0.630	0.154					ARG90	0.020(#2)	CL	A1-D	T
	U-Factor 0.56			SHGC(>1) 0.14				VT(>1) 0.29		CR 49		
445	Outswing: ClimaGuard Premium T / Arg / Clr - 24mm(4mm-4mm)											
	0.151	0.630	0.154					ARG90	0.035(#2)	CL	A1-D	N
	U-Factor 0.40			SHGC(N) 0.34				VT(N) 0.49		CR 53		
446	Outswing - NFRC Default: ClimaGuard Premium T / Arg / Clr - 24mm(4mm-4mm)											
	0.151	0.630	0.154					ARG90	0.035(#2)	CL	A1-D	T
	U-Factor 0.56			SHGC(>1) 0.26				VT(>1) 0.36		CR 49		
447	Outswing: SN 4023 / Arg / Clr - 24mm(4mm-4mm)											
	0.151	0.630	0.154					ARG90	0.026(#2)	CL	A1-D	N
	U-Factor 0.40			SHGC(N) 0.15				VT(N) 0.25		CR 53		
448	Outswing - NFRC Default: SN 4023 / Arg / Clr - 24mm(4mm-4mm)											
	0.151	0.630	0.154					ARG90	0.026(#2)	CL	A1-D	T
	U-Factor 0.56			SHGC(>1) 0.12				VT(>1) 0.19		CR 49		
449	Outswing: SN 5128 / Arg / Clr - 24mm(4mm-4mm)											
	0.151	0.630	0.154					ARG90	0.025(#2)	CL	A1-D	N
	U-Factor 0.40			SHGC(N) 0.18				VT(N) 0.32		CR 53		
450	Outswing - NFRC Default: SN 5128 / Arg / Clr - 24mm(4mm-4mm)											
	0.151	0.630	0.154					ARG90	0.025(#2)	CL	A1-D	T
	U-Factor 0.56			SHGC(>1) 0.14				VT(>1) 0.24		CR 49		

TEST REPORT FOR NEON ENERGY USA INC.

Report No: K0461.02-301-45 R3

Date: 12/18/20

SECTION 6 (Continued)

SIMULATION RESULTS

TOTAL PRODUCT CALCULATIONS (Ultra Outswing and Inswing Door)												
Option Number	Pane Thickness 1 (in)	Gap Width 1 (in)	Pane Thickness 2 (in)	Gap Width 2 (in)	Pane Thickness 3 (in)	Gap Width 3 (in)	Pane Thickness 4 (in)	Gap Fill	Low-e (Surface #)	Tint	Spacer	Grid Type
	U-Factor (Btu/Hr-Ft2-F)			Solar Heat Gain Coefficient (SHGC) Grids (None / <1 / >=1)				Visible Transmittance (VT) Grids (None / <1 / >=1)		Condensation Resistance (CR)		
451	Outswing: SN 6234 / Arg / Clr - 24mm(4mm-4mm)											
	0.151	0.630	0.154					ARG90	0.026(#2)	CL	A1-D	N
	U-Factor 0.40			SHGC(N) 0.21				VT(N) 0.40		CR 53		
452	Outswing - NFRC Default: SN 6234 / Arg / Clr - 24mm(4mm-4mm)											
	0.151	0.630	0.154					ARG90	0.026(#2)	CL	A1-D	T
	U-Factor 0.56			SHGC(>1) 0.16				VT(>1) 0.29		CR 49		
453	Outswing: SN 7037 / Arg / Clr - 24mm(4mm-4mm)											
	0.151	0.630	0.154					ARG90	0.022(#2)	CL	A1-D	N
	U-Factor 0.40			SHGC(N) 0.23				VT(N) 0.44		CR 53		
454	Outswing - NFRC Default: SN 7037 / Arg / Clr - 24mm(4mm-4mm)											
	0.151	0.630	0.154					ARG90	0.022(#2)	CL	A1-D	T
	U-Factor 0.56			SHGC(>1) 0.18				VT(>1) 0.32		CR 49		
455	Outswing: ClimaGuard Neutral 70 / Arg / Clr - 24mm(4mm-4mm)											
	0.148	0.630	0.154					ARG90	0.171(#2)	CL	A1-D	N
	U-Factor 0.43			SHGC(N) 0.37				VT(N) 0.44		CR 53		
456	Outswing - NFRC Default: ClimaGuard Neutral 70 / Arg / Clr - 24mm(4mm-4mm)											
	0.148	0.630	0.154					ARG90	0.171(#2)	CL	A1-D	T
	U-Factor 0.57			SHGC(>1) 0.28				VT(>1) 0.32		CR 48		
457	Outswing: ClimaGuard Neutral 70 / Arg / Clr - 28mm(6mm-5mm)											
	0.226	0.670	0.185					ARG90	0.171(#2)	CL	A1-D	N
	U-Factor 0.43			SHGC(N) 0.36				VT(N) 0.43		CR 53		
458	Outswing - NFRC Default: ClimaGuard Neutral 70 / Arg / Clr - 28mm(6mm-5mm)											
	0.226	0.670	0.185					ARG90	0.171(#2)	CL	A1-D	T
	U-Factor 0.59			SHGC(>1) 0.27				VT(>1) 0.31		CR 46		
459	Outswing: ClimaGuard Neutral 70 / Arg / Clr - 28mm(4mm-4mm)											
	0.226	0.787	0.185					ARG90	0.171(#2)	CL	A1-D	N
	U-Factor 0.43			SHGC(N) 0.35				VT(N) 0.43		CR 51		
460	Outswing - NFRC Default: ClimaGuard Neutral 70 / Arg / Clr - 28mm(4mm-4mm)											
	0.226	0.787	0.185					ARG90	0.171(#2)	CL	A1-D	T
	U-Factor 0.60			SHGC(>1) 0.27				VT(>1) 0.31		CR 44		

TEST REPORT FOR NEON ENERGY USA INC.

Report No: K0461.02-301-45 R3

Date: 12/18/20

SECTION 6 (Continued)

SIMULATION RESULTS

TOTAL PRODUCT CALCULATIONS (Ultra Outswing and Inswing Door)												
Option Number	Pane Thickness 1 (in)	Gap Width 1 (in)	Pane Thickness 2 (in)	Gap Width 2 (in)	Pane Thickness 3 (in)	Gap Width 3 (in)	Pane Thickness 4 (in)	Gap Fill	Low-e (Surface #)	Tint	Spacer	Grid Type
	U-Factor (Btu/Hr-Ft ² -F)		Solar Heat Gain Coefficient (SHGC) Grids (None / <1 / >=1)				Visible Transmittance (VT) Grids (None / <1 / >=1)		Condensation Resistance (CR)			
461	Outswing: SNX 6227 / Arg / SNX 6227 / Arg / Clr - 36mm(4mm-4mm-4mm)											
	0.151	0.470	0.151	0.470	0.154			ARG90	0.020(#2) / 0.020(#4)	CL	TS-D	N
	U-Factor 0.29		SHGC(N) 0.14				VT(N) 0.28		CR 55			
462	Outswing: SNX 6227 / Arg / SNX 6227 / Arg / Clr - 41mm(6mm-6mm-5mm)											
	0.221	0.470	0.221	0.470	0.185			ARG90	0.020(#2) / 0.020(#4)	CL	TS-D	N
	U-Factor 0.29		SHGC(N) 0.14				VT(N) 0.27		CR 55			
463	Outswing: SNX 5123 / Arg / SNX 5123 / Arg / Clr - 41mm(6mm-6mm-5mm)											
	0.221	0.470	0.221	0.470	0.185			ARG90	0.021(#2) / 0.021(#4)	CL	TS-D	N
	U-Factor 0.29		SHGC(N) 0.11				VT(N) 0.19		CR 55			
464	Outswing: SNX 5123 / Arg / 3mmClr-030PVB-3mmIS20 - 28mm (6mm-6mm)											
	0.221	0.625	0.264					ARG90	0.021(#2) / 0.198(#4)	CL	TS-D	N
	U-Factor 0.35		SHGC(N) 0.15				VT(N) 0.31		CR 51			
465	Outswing - NFRC Default: SNX 5123 / Arg / 3mmClr-030PVB-3mmIS20 - 28mm (6mm-6mm)											
	0.221	0.625	0.264					ARG90	0.021(#2) / 0.198(#4)	CL	TS-D	T
	U-Factor 0.47		SHGC(>1) 0.12				VT(>1) 0.23		CR 51			
466	Outswing - 1 Horizontal TDL: SNX 5123 / Arg / Clr - 28mm(6mm-6mm)											
	0.221	0.630	0.224					ARG90	0.021(#2)	CL	A1-D	T
	U-Factor 0.41		SHGC(>1) 0.12				VT(>1) 0.24		CR 53			
467	Outswing - 1 Horizontal TDL: SNX 6227 / Arg / Clr - 28mm(6mm-6mm)											
	0.221	0.630	0.224					ARG90	0.020(#2)	CL	A1-D	T
	U-Factor 0.41		SHGC(>1) 0.14				VT(>1) 0.28		CR 53			
468	Outswing - 1 Horizontal TDL: ClimaGuard Premium T / Arg / Clr - 27mm(6mm-5mm)											
	0.230	0.630	0.185					ARG90	0.035(#2)	CL	A1-D	T
	U-Factor 0.41		SHGC(>1) 0.25				VT(>1) 0.35		CR 53			
469	Outswing - 1 Horizontal TDL: SN 4023 / Arg / Clr - 27mm(6mm-5mm)											
	0.230	0.630	0.185					ARG90	0.026(#2)	CL	A1-D	T
	U-Factor 0.41		SHGC(>1) 0.12				VT(>1) 0.18		CR 53			
470	Outswing - 1 Horizontal TDL: SN 5128 / Arg / Clr - 27mm(6mm-5mm)											
	0.230	0.630	0.185					ARG90	0.025(#2)	CL	A1-D	T
	U-Factor 0.41		SHGC(>1) 0.14				VT(>1) 0.23		CR 53			

TEST REPORT FOR NEON ENERGY USA INC.

Report No: K0461.02-301-45 R3

Date: 12/18/20

SECTION 6 (Continued)

SIMULATION RESULTS

TOTAL PRODUCT CALCULATIONS (Ultra Outswing and Inswing Door)												
Option Number	Pane Thickness 1 (in)	Gap Width 1 (in)	Pane Thickness 2 (in)	Gap Width 2 (in)	Pane Thickness 3 (in)	Gap Width 3 (in)	Pane Thickness 4 (in)	Gap Fill	Low-e (Surface #)	Tint	Spacer	Grid Type
	U-Factor (Btu/Hr-Ft ² -F)			Solar Heat Gain Coefficient (SHGC) Grids (None / <1 / >=1)				Visible Transmittance (VT) Grids (None / <1 / >=1)		Condensation Resistance (CR)		
471	Outswing - 1 Horizontal TDL: SN 6234 / Arg / Clr - 27mm(6mm-5mm)											
	0.230	0.630	0.185					ARG90	0.026(#2)	CL	A1-D	T
	U-Factor 0.41			SHGC(>1) 0.16				VT(>1) 0.29		CR 53		
472	Outswing - 1 Horizontal TDL: SN 7037 / Arg / Clr - 27mm(6mm-5mm)											
	0.230	0.630	0.185					ARG90	0.022(#2)	CL	A1-D	T
	U-Factor 0.41			SHGC(>1) 0.18				VT(>1) 0.32		CR 53		
473	Outswing - 1 Horizontal TDL: ClimaGuard Neutral 70 / Arg / Clr - 27mm(6mm-5mm)											
	0.226	0.630	0.185					ARG90	0.171(#2)	CL	A1-D	T
	U-Factor 0.44			SHGC(>1) 0.27				VT(>1) 0.31		CR 53		
474	Outswing - 1 Horizontal TDL: SNX 6227 / Arg / Clr - 24mm(4mm-4mm)											
	0.151	0.630	0.154					ARG90	0.020(#2)	CL	A1-D	T
	U-Factor 0.41			SHGC(>1) 0.14				VT(>1) 0.29		CR 53		
475	Outswing - 1 Horizontal TDL: ClimaGuard Premium T / Arg / Clr - 24mm(4mm-4mm)											
	0.151	0.630	0.154					ARG90	0.035(#2)	CL	A1-D	T
	U-Factor 0.41			SHGC(>1) 0.26				VT(>1) 0.36		CR 53		
476	Outswing - 1 Horizontal TDL: SN 4023 / Arg / Clr - 24mm(4mm-4mm)											
	0.151	0.630	0.154					ARG90	0.026(#2)	CL	A1-D	T
	U-Factor 0.41			SHGC(>1) 0.12				VT(>1) 0.19		CR 53		
477	Outswing - 1 Horizontal TDL: SN 5128 / Arg / Clr - 24mm(4mm-4mm)											
	0.151	0.630	0.154					ARG90	0.025(#2)	CL	A1-D	T
	U-Factor 0.41			SHGC(>1) 0.14				VT(>1) 0.24		CR 53		
478	Outswing - 1 Horizontal TDL: SN 6234 / Arg / Clr - 24mm(4mm-4mm)											
	0.151	0.630	0.154					ARG90	0.026(#2)	CL	A1-D	T
	U-Factor 0.41			SHGC(>1) 0.16				VT(>1) 0.29		CR 53		
479	Outswing - 1 Horizontal TDL: SN 7037 / Arg / Clr - 24mm(4mm-4mm)											
	0.151	0.630	0.154					ARG90	0.022(#2)	CL	A1-D	T
	U-Factor 0.41			SHGC(>1) 0.18				VT(>1) 0.32		CR 53		
480	Outswing - 1 Horizontal TDL: ClimaGuard Neutral 70 / Arg / Clr - 24mm(4mm-4mm)											
	0.148	0.630	0.154					ARG90	0.171(#2)	CL	A1-D	T
	U-Factor 0.44			SHGC(>1) 0.28				VT(>1) 0.32		CR 53		

TEST REPORT FOR NEON ENERGY USA INC.

Report No: K0461.02-301-45 R3

Date: 12/18/20

SECTION 6 (Continued)

SIMULATION RESULTS

TOTAL PRODUCT CALCULATIONS (Ultra Outswing and Inswing Door)												
Option Number	Pane Thickness 1 (in)	Gap Width 1 (in)	Pane Thickness 2 (in)	Gap Width 2 (in)	Pane Thickness 3 (in)	Gap Width 3 (in)	Pane Thickness 4 (in)	Gap Fill	Low-e (Surface #)	Tint	Spacer	Grid Type
	U-Factor (Btu/Hr-Ft2-F)		Solar Heat Gain Coefficient (SHGC) Grids (None / <1 / >=1)				Visible Transmittance (VT) Grids (None / <1 / >=1)		Condensation Resistance (CR)			
481	Outswing - 1 Horizontal TDL: ClimaGuard Neutral 70 / Arg / Clr - 28mm(6mm-5mm)											
	0.226	0.670	0.185					ARG90	0.171(#2)	CL	A1-D	T
	U-Factor 0.44		SHGC(>1) 0.27				VT(>1) 0.31		CR 53			
482	Outswing - 1 Horizontal TDL: ClimaGuard Neutral 70 / Arg / Clr - 28mm(4mm-4mm)											
	0.226	0.787	0.185					ARG90	0.171(#2)	CL	A1-D	T
	U-Factor 0.45		SHGC(>1) 0.27				VT(>1) 0.31		CR 51			
483	Outswing - 1 Horizontal TDL: SNX 5123 / Arg / 3mmClr-030PVB-3mmIS20 - 28mm (6mm-6mm)											
	0.221	0.625	0.264					ARG90	0.021(#2) / 0.198(#4)	CL	TS-D	T
	U-Factor 0.36		SHGC(>1) 0.12				VT(>1) 0.23		CR 51			
484	Outswing - 2 Horizontal TDLS: SNX 5123 / Arg / Clr - 28mm(6mm-6mm)											
	0.221	0.630	0.224					ARG90	0.021(#2)	CL	A1-D	T
	U-Factor 0.42		SHGC(>1) 0.12				VT(>1) 0.24		CR 53			
485	Outswing - 2 Horizontal TDLS: SNX 6227 / Arg / Clr - 28mm(6mm-6mm)											
	0.221	0.630	0.224					ARG90	0.020(#2)	CL	A1-D	T
	U-Factor 0.42		SHGC(>1) 0.14				VT(>1) 0.28		CR 53			
486	Outswing - 2 Horizontal TDLS: ClimaGuard Premium T / Arg / Clr - 27mm(6mm-5mm)											
	0.230	0.630	0.185					ARG90	0.035(#2)	CL	A1-D	T
	U-Factor 0.43		SHGC(>1) 0.25				VT(>1) 0.35		CR 53			
487	Outswing - 2 Horizontal TDLS: SN 4023 / Arg / Clr - 27mm(6mm-5mm)											
	0.230	0.630	0.185					ARG90	0.026(#2)	CL	A1-D	T
	U-Factor 0.42		SHGC(>1) 0.12				VT(>1) 0.18		CR 53			
488	Outswing - 2 Horizontal TDLS: SN 5128 / Arg / Clr - 27mm(6mm-5mm)											
	0.230	0.630	0.185					ARG90	0.025(#2)	CL	A1-D	T
	U-Factor 0.42		SHGC(>1) 0.14				VT(>1) 0.23		CR 53			
489	Outswing - 2 Horizontal TDLS: SN 6234 / Arg / Clr - 27mm(6mm-5mm)											
	0.230	0.630	0.185					ARG90	0.026(#2)	CL	A1-D	T
	U-Factor 0.42		SHGC(>1) 0.16				VT(>1) 0.29		CR 53			
490	Outswing - 2 Horizontal TDLS: SN 7037 / Arg / Clr - 27mm(6mm-5mm)											
	0.230	0.630	0.185					ARG90	0.022(#2)	CL	A1-D	T
	U-Factor 0.42		SHGC(>1) 0.18				VT(>1) 0.32		CR 53			

TEST REPORT FOR NEON ENERGY USA INC.

Report No: K0461.02-301-45 R3

Date: 12/18/20

SECTION 6 (Continued) SIMULATION RESULTS

TOTAL PRODUCT CALCULATIONS (Ultra Outswing and Inswing Door)												
Option Number	Pane Thickness 1 (in)	Gap Width 1 (in)	Pane Thickness 2 (in)	Gap Width 2 (in)	Pane Thickness 3 (in)	Gap Width 3 (in)	Pane Thickness 4 (in)	Gap Fill	Low-e (Surface #)	Tint	Spacer	Grid Type
	U-Factor (Btu/Hr-Ft2-F)			Solar Heat Gain Coefficient (SHGC) Grids (None / <1 / >=1)				Visible Transmittance (VT) Grids (None / <1 / >=1)		Condensation Resistance (CR)		
491	Outswing - 2 Horizontal TDs: ClimaGuard Neutral 70 / Arg / Clr - 27mm(6mm-5mm)											
	0.226	0.630	0.185					ARG90	0.171(#2)	CL	A1-D	T
	U-Factor 0.45			SHGC(>1) 0.27				VT(>1) 0.31		CR 53		
492	Outswing - 2 Horizontal TDs: SNX 6227 / Arg / Clr - 24mm(4mm-4mm)											
	0.151	0.630	0.154					ARG90	0.020(#2)	CL	A1-D	T
	U-Factor 0.42			SHGC(>1) 0.14				VT(>1) 0.29		CR 53		
493	Outswing - 2 Horizontal TDs: ClimaGuard Premium T / Arg / Clr - 24mm(4mm-4mm)											
	0.151	0.630	0.154					ARG90	0.035(#2)	CL	A1-D	T
	U-Factor 0.43			SHGC(>1) 0.26				VT(>1) 0.36		CR 53		
494	Outswing - 2 Horizontal TDs: SN 4023 / Arg / Clr - 24mm(4mm-4mm)											
	0.151	0.630	0.154					ARG90	0.026(#2)	CL	A1-D	T
	U-Factor 0.43			SHGC(>1) 0.12				VT(>1) 0.19		CR 53		
495	Outswing - 2 Horizontal TDs: SN 5128 / Arg / Clr - 24mm(4mm-4mm)											
	0.151	0.630	0.154					ARG90	0.025(#2)	CL	A1-D	T
	U-Factor 0.43			SHGC(>1) 0.14				VT(>1) 0.24		CR 53		
496	Outswing - 2 Horizontal TDs: SN 6234 / Arg / Clr - 24mm(4mm-4mm)											
	0.151	0.630	0.154					ARG90	0.026(#2)	CL	A1-D	T
	U-Factor 0.43			SHGC(>1) 0.16				VT(>1) 0.29		CR 53		
497	Outswing - 2 Horizontal TDs: SN 7037 / Arg / Clr - 24mm(4mm-4mm)											
	0.151	0.630	0.154					ARG90	0.022(#2)	CL	A1-D	T
	U-Factor 0.43			SHGC(>1) 0.18				VT(>1) 0.32		CR 53		
498	Outswing - 2 Horizontal TDs: ClimaGuard Neutral 70 / Arg / Clr - 24mm(4mm-4mm)											
	0.148	0.630	0.154					ARG90	0.171(#2)	CL	A1-D	T
	U-Factor 0.46			SHGC(>1) 0.28				VT(>1) 0.32		CR 53		
499	Outswing - 2 Horizontal TDs: ClimaGuard Neutral 70 / Arg / Clr - 28mm(6mm-5mm)											
	0.226	0.670	0.185					ARG90	0.171(#2)	CL	A1-D	T
	U-Factor 0.46			SHGC(>1) 0.27				VT(>1) 0.31		CR 53		
500	Outswing - 2 Horizontal TDs: ClimaGuard Neutral 70 / Arg / Clr - 28mm(4mm-4mm)											
	0.226	0.787	0.185					ARG90	0.171(#2)	CL	A1-D	T
	U-Factor 0.46			SHGC(>1) 0.27				VT(>1) 0.31		CR 51		

TEST REPORT FOR NEON ENERGY USA INC.

Report No: K0461.02-301-45 R3

Date: 12/18/20

SECTION 6 (Continued)

SIMULATION RESULTS

TOTAL PRODUCT CALCULATIONS (Ultra Outswing and Inswing Door)												
Option Number	Pane Thickness 1 (in)	Gap Width 1 (in)	Pane Thickness 2 (in)	Gap Width 2 (in)	Pane Thickness 3 (in)	Gap Width 3 (in)	Pane Thickness 4 (in)	Gap Fill	Low-e (Surface #)	Tint	Spacer	Grid Type
	U-Factor (Btu/Hr-Ft ² -F)			Solar Heat Gain Coefficient (SHGC) Grids (None / <1 / >=1)				Visible Transmittance (VT) Grids (None / <1 / >=1)		Condensation Resistance (CR)		
501	Outswing - 2 Horizontal TDs: SNX 5123 / Arg / 3mmClr-030PVB-3mmI520 - 28mm (6mm-6mm)											
	0.221	0.625	0.264					ARG90	0.021(#2) / 0.198(#4)	CL	TS-D	T
	U-Factor 0.37			SHGC(>1) 0.12				VT(>1) 0.23		CR 51		
502	Outswing - 3 Horizontal TDs: SNX 5123 / Arg / Clr - 28mm(6mm-6mm)											
	0.221	0.630	0.224					ARG90	0.021(#2)	CL	A1-D	T
	U-Factor 0.44			SHGC(>1) 0.12				VT(>1) 0.24		CR 53		
503	Outswing - 3 Horizontal TDs: SNX 6227 / Arg / Clr - 28mm(6mm-6mm)											
	0.221	0.630	0.224					ARG90	0.020(#2)	CL	A1-D	T
	U-Factor 0.44			SHGC(>1) 0.14				VT(>1) 0.28		CR 53		
504	Outswing - 3 Horizontal TDs: ClimaGuard Premium T / Arg / Clr - 27mm(6mm-5mm)											
	0.230	0.630	0.185					ARG90	0.035(#2)	CL	A1-D	T
	U-Factor 0.44			SHGC(>1) 0.25				VT(>1) 0.35		CR 53		
505	Outswing - 3 Horizontal TDs: SN 4023 / Arg / Clr - 27mm(6mm-5mm)											
	0.230	0.630	0.185					ARG90	0.026(#2)	CL	A1-D	T
	U-Factor 0.44			SHGC(>1) 0.12				VT(>1) 0.18		CR 53		
506	Outswing - 3 Horizontal TDs: SN 5128 / Arg / Clr - 27mm(6mm-5mm)											
	0.230	0.630	0.185					ARG90	0.025(#2)	CL	A1-D	T
	U-Factor 0.44			SHGC(>1) 0.14				VT(>1) 0.23		CR 53		
507	Outswing - 3 Horizontal TDs: SN 6234 / Arg / Clr - 27mm(6mm-5mm)											
	0.230	0.630	0.185					ARG90	0.026(#2)	CL	A1-D	T
	U-Factor 0.44			SHGC(>1) 0.16				VT(>1) 0.29		CR 53		
508	Outswing - 3 Horizontal TDs: SN 7037 / Arg / Clr - 27mm(6mm-5mm)											
	0.230	0.630	0.185					ARG90	0.022(#2)	CL	A1-D	T
	U-Factor 0.44			SHGC(>1) 0.18				VT(>1) 0.32		CR 53		
509	Outswing - 3 Horizontal TDs: ClimaGuard Neutral 70 / Arg / Clr - 27mm(6mm-5mm)											
	0.226	0.630	0.185					ARG90	0.171(#2)	CL	A1-D	T
	U-Factor 0.47			SHGC(>1) 0.27				VT(>1) 0.31		CR 53		
510	Outswing - 3 Horizontal TDs: SNX 6227 / Arg / Clr - 24mm(4mm-4mm)											
	0.151	0.630	0.154					ARG90	0.020(#2)	CL	A1-D	T
	U-Factor 0.44			SHGC(>1) 0.14				VT(>1) 0.29		CR 53		

TEST REPORT FOR NEON ENERGY USA INC.

Report No: K0461.02-301-45 R3

Date: 12/18/20

SECTION 6 (Continued)

SIMULATION RESULTS

TOTAL PRODUCT CALCULATIONS (Ultra Outswing and Inswing Door)												
Option Number	Pane Thickness 1 (in)	Gap Width 1 (in)	Pane Thickness 2 (in)	Gap Width 2 (in)	Pane Thickness 3 (in)	Gap Width 3 (in)	Pane Thickness 4 (in)	Gap Fill	Low-e (Surface #)	Tint	Spacer	Grid Type
	U-Factor (Btu/Hr-Ft ² -F)			Solar Heat Gain Coefficient (SHGC) Grids (None / <1 / >=1)				Visible Transmittance (VT) Grids (None / <1 / >=1)		Condensation Resistance (CR)		
511	Outswing - 3 Horizontal TDs: ClimaGuard Premium T / Arg / Clr - 24mm(4mm-4mm)											
	0.151	0.630	0.154					ARG90	0.035(#2)	CL	A1-D	T
	U-Factor 0.44			SHGC(>1) 0.26				VT(>1) 0.36		CR 53		
512	Outswing - 3 Horizontal TDs: SN 4023 / Arg / Clr - 24mm(4mm-4mm)											
	0.151	0.630	0.154					ARG90	0.026(#2)	CL	A1-D	T
	U-Factor 0.44			SHGC(>1) 0.12				VT(>1) 0.19		CR 53		
513	Outswing - 3 Horizontal TDs: SN 5128 / Arg / Clr - 24mm(4mm-4mm)											
	0.151	0.630	0.154					ARG90	0.025(#2)	CL	A1-D	T
	U-Factor 0.44			SHGC(>1) 0.14				VT(>1) 0.24		CR 53		
514	Outswing - 3 Horizontal TDs: SN 6234 / Arg / Clr - 24mm(4mm-4mm)											
	0.151	0.630	0.154					ARG90	0.026(#2)	CL	A1-D	T
	U-Factor 0.44			SHGC(>1) 0.16				VT(>1) 0.29		CR 53		
515	Outswing - 3 Horizontal TDs: SN 7037 / Arg / Clr - 24mm(4mm-4mm)											
	0.151	0.630	0.154					ARG90	0.022(#2)	CL	A1-D	T
	U-Factor 0.44			SHGC(>1) 0.18				VT(>1) 0.32		CR 53		
516	Outswing - 3 Horizontal TDs: ClimaGuard Neutral 70 / Arg / Clr - 24mm(4mm-4mm)											
	0.148	0.630	0.154					ARG90	0.171(#2)	CL	A1-D	T
	U-Factor 0.47			SHGC(>1) 0.28				VT(>1) 0.32		CR 53		
517	Outswing - 3 Horizontal TDs: ClimaGuard Neutral 70 / Arg / Clr - 28mm(6mm-5mm)											
	0.226	0.670	0.185					ARG90	0.171(#2)	CL	A1-D	T
	U-Factor 0.47			SHGC(>1) 0.27				VT(>1) 0.31		CR 53		
518	Outswing - 3 Horizontal TDs: ClimaGuard Neutral 70 / Arg / Clr - 28mm(4mm-4mm)											
	0.226	0.787	0.185					ARG90	0.171(#2)	CL	A1-D	T
	U-Factor 0.48			SHGC(>1) 0.27				VT(>1) 0.31		CR 51		
519	Outswing - 3 Horizontal TDs: SNX 5123 / Arg / 3mmClr-030PVB-3mmIS20 - 28mm (6mm-6mm)											
	0.221	0.625	0.264					ARG90	0.021(#2) / 0.198(#4)	CL	TS-D	T
	U-Factor 0.38			SHGC(>1) 0.12				VT(>1) 0.23		CR 51		
520	Outswing - 4 Horizontal TDs: SNX 5123 / Arg / Clr - 28mm(6mm-6mm)											
	0.221	0.630	0.224					ARG90	0.021(#2)	CL	A1-D	T
	U-Factor 0.45			SHGC(>1) 0.12				VT(>1) 0.24		CR 53		

TEST REPORT FOR NEON ENERGY USA INC.

Report No: K0461.02-301-45 R3

Date: 12/18/20

SECTION 6 (Continued)

SIMULATION RESULTS

TOTAL PRODUCT CALCULATIONS (Ultra Outswing and Inswing Door)												
Option Number	Pane Thickness 1 (in)	Gap Width 1 (in)	Pane Thickness 2 (in)	Gap Width 2 (in)	Pane Thickness 3 (in)	Gap Width 3 (in)	Pane Thickness 4 (in)	Gap Fill	Low-e (Surface #)	Tint	Spacer	Grid Type
	U-Factor (Btu/Hr-Ft2-F)			Solar Heat Gain Coefficient (SHGC) Grids (None / <1 / >=1)				Visible Transmittance (VT) Grids (None / <1 / >=1)		Condensation Resistance (CR)		
521	Outswing - 4 Horizontal TDs: SNX 6227 / Arg / Clr - 28mm(6mm-6mm)											
	0.221	0.630	0.224					ARG90	0.020(#2)	CL	A1-D	T
	U-Factor 0.45			SHGC(>1) 0.14				VT(>1) 0.28		CR 53		
522	Outswing - 4 Horizontal TDs: ClimaGuard Premium T / Arg / Clr - 27mm(6mm-5mm)											
	0.230	0.630	0.185					ARG90	0.035(#2)	CL	A1-D	T
	U-Factor 0.46			SHGC(>1) 0.25				VT(>1) 0.35		CR 53		
523	Outswing - 4 Horizontal TDs: SN 4023 / Arg / Clr - 27mm(6mm-5mm)											
	0.230	0.630	0.185					ARG90	0.026(#2)	CL	A1-D	T
	U-Factor 0.45			SHGC(>1) 0.12				VT(>1) 0.18		CR 53		
524	Outswing - 4 Horizontal TDs: SN 5128 / Arg / Clr - 27mm(6mm-5mm)											
	0.230	0.630	0.185					ARG90	0.025(#2)	CL	A1-D	T
	U-Factor 0.45			SHGC(>1) 0.14				VT(>1) 0.23		CR 53		
525	Outswing - 4 Horizontal TDs: SN 6234 / Arg / Clr - 27mm(6mm-5mm)											
	0.230	0.630	0.185					ARG90	0.026(#2)	CL	A1-D	T
	U-Factor 0.45			SHGC(>1) 0.16				VT(>1) 0.29		CR 53		
526	Outswing - 4 Horizontal TDs: SN 7037 / Arg / Clr - 27mm(6mm-5mm)											
	0.230	0.630	0.185					ARG90	0.022(#2)	CL	A1-D	T
	U-Factor 0.45			SHGC(>1) 0.18				VT(>1) 0.32		CR 53		
527	Outswing - 4 Horizontal TDs: ClimaGuard Neutral 70 / Arg / Clr - 27mm(6mm-5mm)											
	0.226	0.630	0.185					ARG90	0.171(#2)	CL	A1-D	T
	U-Factor 0.48			SHGC(>1) 0.27				VT(>1) 0.31		CR 53		
528	Outswing - 4 Horizontal TDs: SNX 6227 / Arg / Clr - 24mm(4mm-4mm)											
	0.151	0.630	0.154					ARG90	0.020(#2)	CL	A1-D	T
	U-Factor 0.45			SHGC(>1) 0.14				VT(>1) 0.29		CR 53		
529	Outswing - 4 Horizontal TDs: ClimaGuard Premium T / Arg / Clr - 24mm(4mm-4mm)											
	0.151	0.630	0.154					ARG90	0.035(#2)	CL	A1-D	T
	U-Factor 0.46			SHGC(>1) 0.26				VT(>1) 0.36		CR 53		
530	Outswing - 4 Horizontal TDs: SN 4023 / Arg / Clr - 24mm(4mm-4mm)											
	0.151	0.630	0.154					ARG90	0.026(#2)	CL	A1-D	T
	U-Factor 0.45			SHGC(>1) 0.12				VT(>1) 0.19		CR 53		

TEST REPORT FOR NEON ENERGY USA INC.

Report No: K0461.02-301-45 R3

Date: 12/18/20

SECTION 6 (Continued)

SIMULATION RESULTS

TOTAL PRODUCT CALCULATIONS (Ultra Outswing and Inswing Door)												
Option Number	Pane Thickness 1 (in)	Gap Width 1 (in)	Pane Thickness 2 (in)	Gap Width 2 (in)	Pane Thickness 3 (in)	Gap Width 3 (in)	Pane Thickness 4 (in)	Gap Fill	Low-e (Surface #)	Tint	Spacer	Grid Type
	U-Factor (Btu/Hr-Ft2-F)			Solar Heat Gain Coefficient (SHGC) Grids (None / <1 / >=1)				Visible Transmittance (VT) Grids (None / <1 / >=1)		Condensation Resistance (CR)		
531	Outswing - 4 Horizontal TDs: SN 5128 / Arg / Clr - 24mm(4mm-4mm)											
	0.151	0.630	0.154					ARG90	0.025(#2)	CL	A1-D	T
	U-Factor 0.45			SHGC(>1) 0.14				VT(>1) 0.24		CR 53		
532	Outswing - 4 Horizontal TDs: SN 6234 / Arg / Clr - 24mm(4mm-4mm)											
	0.151	0.630	0.154					ARG90	0.026(#2)	CL	A1-D	T
	U-Factor 0.45			SHGC(>1) 0.16				VT(>1) 0.29		CR 53		
533	Outswing - 4 Horizontal TDs: SN 7037 / Arg / Clr - 24mm(4mm-4mm)											
	0.151	0.630	0.154					ARG90	0.022(#2)	CL	A1-D	T
	U-Factor 0.45			SHGC(>1) 0.18				VT(>1) 0.32		CR 53		
534	Outswing - 4 Horizontal TDs: ClimaGuard Neutral 70 / Arg / Clr - 24mm(4mm-4mm)											
	0.148	0.630	0.154					ARG90	0.171(#2)	CL	A1-D	T
	U-Factor 0.48			SHGC(>1) 0.28				VT(>1) 0.32		CR 53		
535	Outswing - 4 Horizontal TDs: ClimaGuard Neutral 70 / Arg / Clr - 28mm(6mm-5mm)											
	0.226	0.670	0.185					ARG90	0.171(#2)	CL	A1-D	T
	U-Factor 0.48			SHGC(>1) 0.27				VT(>1) 0.31		CR 53		
536	Outswing - 4 Horizontal TDs: ClimaGuard Neutral 70 / Arg / Clr - 28mm(4mm-4mm)											
	0.226	0.787	0.185					ARG90	0.171(#2)	CL	A1-D	T
	U-Factor 0.49			SHGC(>1) 0.27				VT(>1) 0.31		CR 51		
537	Outswing - 4 Horizontal TDs: SNX 5123 / Arg / 3mmClr-030PVB-3mmIS20 - 28mm (6mm-6mm)											
	0.221	0.625	0.264					ARG90	0.021(#2) / 0.198(#4)	CL	TS-D	T
	U-Factor 0.39			SHGC(>1) 0.12				VT(>1) 0.23		CR 51		
538	Outswing - 1 Vertical TD: SNX 5123 / Arg / Clr - 28mm(6mm-6mm)											
	0.221	0.630	0.224					ARG90	0.021(#2)	CL	A1-D	T
	U-Factor 0.43			SHGC(>1) 0.12				VT(>1) 0.24		CR 53		
539	Outswing - 1 Vertical TD: SNX 6227 / Arg / Clr - 28mm(6mm-6mm)											
	0.221	0.630	0.224					ARG90	0.020(#2)	CL	A1-D	T
	U-Factor 0.43			SHGC(>1) 0.14				VT(>1) 0.28		CR 53		
540	Outswing - 1 Vertical TD: ClimaGuard Premium T / Arg / Clr - 27mm(6mm-5mm)											
	0.230	0.630	0.185					ARG90	0.035(#2)	CL	A1-D	T
	U-Factor 0.44			SHGC(>1) 0.25				VT(>1) 0.35		CR 53		

TEST REPORT FOR NEON ENERGY USA INC.

Report No: K0461.02-301-45 R3

Date: 12/18/20

SECTION 6 (Continued) SIMULATION RESULTS

TOTAL PRODUCT CALCULATIONS (Ultra Outswing and Inswing Door)												
Option Number	Pane Thickness 1 (in)	Gap Width 1 (in)	Pane Thickness 2 (in)	Gap Width 2 (in)	Pane Thickness 3 (in)	Gap Width 3 (in)	Pane Thickness 4 (in)	Gap Fill	Low-e (Surface #)	Tint	Spacer	Grid Type
	U-Factor (Btu/Hr-Ft2-F)			Solar Heat Gain Coefficient (SHGC) Grids (None / <1 / >=1)				Visible Transmittance (VT) Grids (None / <1 / >=1)		Condensation Resistance (CR)		
541	Outswing - 1 Vertical TDL: SN 4023 / Arg / Clr - 27mm(6mm-5mm)											
	0.230	0.630	0.185					ARG90	0.026(#2)	CL	A1-D	T
	U-Factor 0.44			SHGC(>1) 0.12				VT(>1) 0.18		CR 53		
542	Outswing - 1 Vertical TDL: SN 5128 / Arg / Clr - 27mm(6mm-5mm)											
	0.230	0.630	0.185					ARG90	0.025(#2)	CL	A1-D	T
	U-Factor 0.43			SHGC(>1) 0.14				VT(>1) 0.23		CR 53		
543	Outswing - 1 Vertical TDL: SN 6234 / Arg / Clr - 27mm(6mm-5mm)											
	0.230	0.630	0.185					ARG90	0.026(#2)	CL	A1-D	T
	U-Factor 0.43			SHGC(>1) 0.16				VT(>1) 0.29		CR 53		
544	Outswing - 1 Vertical TDL: SN 7037 / Arg / Clr - 27mm(6mm-5mm)											
	0.230	0.630	0.185					ARG90	0.022(#2)	CL	A1-D	T
	U-Factor 0.43			SHGC(>1) 0.18				VT(>1) 0.32		CR 53		
545	Outswing - 1 Vertical TDL: ClimaGuard Neutral 70 / Arg / Clr - 27mm(6mm-5mm)											
	0.226	0.630	0.185					ARG90	0.171(#2)	CL	A1-D	T
	U-Factor 0.46			SHGC(>1) 0.27				VT(>1) 0.31		CR 53		
546	Outswing - 1 Vertical TDL: SNX 6227 / Arg / Clr - 24mm(4mm-4mm)											
	0.151	0.630	0.154					ARG90	0.020(#2)	CL	A1-D	T
	U-Factor 0.43			SHGC(>1) 0.14				VT(>1) 0.29		CR 53		
547	Outswing - 1 Vertical TDL: ClimaGuard Premium T / Arg / Clr - 24mm(4mm-4mm)											
	0.151	0.630	0.154					ARG90	0.035(#2)	CL	A1-D	T
	U-Factor 0.44			SHGC(>1) 0.26				VT(>1) 0.36		CR 53		
548	Outswing - 1 Vertical TDL: SN 4023 / Arg / Clr - 24mm(4mm-4mm)											
	0.151	0.630	0.154					ARG90	0.026(#2)	CL	A1-D	T
	U-Factor 0.44			SHGC(>1) 0.12				VT(>1) 0.19		CR 53		
549	Outswing - 1 Vertical TDL: SN 5128 / Arg / Clr - 24mm(4mm-4mm)											
	0.151	0.630	0.154					ARG90	0.025(#2)	CL	A1-D	T
	U-Factor 0.44			SHGC(>1) 0.14				VT(>1) 0.24		CR 53		
550	Outswing - 1 Vertical TDL: SN 6234 / Arg / Clr - 24mm(4mm-4mm)											
	0.151	0.630	0.154					ARG90	0.026(#2)	CL	A1-D	T
	U-Factor 0.44			SHGC(>1) 0.16				VT(>1) 0.29		CR 53		

TEST REPORT FOR NEON ENERGY USA INC.

Report No: K0461.02-301-45 R3

Date: 12/18/20

SECTION 6 (Continued)

SIMULATION RESULTS

TOTAL PRODUCT CALCULATIONS (Ultra Outswing and Inswing Door)												
Option Number	Pane Thickness 1 (in)	Gap Width 1 (in)	Pane Thickness 2 (in)	Gap Width 2 (in)	Pane Thickness 3 (in)	Gap Width 3 (in)	Pane Thickness 4 (in)	Gap Fill	Low-e (Surface #)	Tint	Spacer	Grid Type
	U-Factor (Btu/Hr-Ft2-F)			Solar Heat Gain Coefficient (SHGC) Grids (None / <1 / >=1)				Visible Transmittance (VT) Grids (None / <1 / >=1)		Condensation Resistance (CR)		
551	Outswing - 1 Vertical TDL: SN 7037 / Arg / Clr - 24mm(4mm-4mm)											
	0.151	0.630	0.154					ARG90	0.022(#2)	CL	A1-D	T
	U-Factor 0.43			SHGC(>1) 0.18				VT(>1) 0.32		CR 53		
552	Outswing - 1 Vertical TDL: ClimaGuard Neutral 70 / Arg / Clr - 24mm(4mm-4mm)											
	0.148	0.630	0.154					ARG90	0.171(#2)	CL	A1-D	T
	U-Factor 0.46			SHGC(>1) 0.28				VT(>1) 0.32		CR 53		
553	Outswing - 1 Vertical TDL: ClimaGuard Neutral 70 / Arg / Clr - 28mm(6mm-5mm)											
	0.226	0.670	0.185					ARG90	0.171(#2)	CL	A1-D	T
	U-Factor 0.46			SHGC(>1) 0.27				VT(>1) 0.31		CR 53		
554	Outswing - 1 Vertical TDL: ClimaGuard Neutral 70 / Arg / Clr - 28mm(4mm-4mm)											
	0.226	0.787	0.185					ARG90	0.171(#2)	CL	A1-D	T
	U-Factor 0.47			SHGC(>1) 0.27				VT(>1) 0.31		CR 51		
555	Outswing - 1 Vertical TDL: SNX 5123 / Arg / 3mmClr-030PVB-3mmIS20 - 28mm (6mm-6mm)											
	0.221	0.625	0.264					ARG90	0.021(#2) / 0.198(#4)	CL	TS-D	T
	U-Factor 0.37			SHGC(>1) 0.12				VT(>1) 0.23		CR 51		
556	Outswing - 2 Vertical TDLS: SNX 5123 / Arg / Clr - 28mm(6mm-6mm)											
	0.221	0.630	0.224					ARG90	0.021(#2)	CL	A1-D	T
	U-Factor 0.48			SHGC(>1) 0.12				VT(>1) 0.24		CR 53		
557	Outswing - 2 Vertical TDLS: SNX 6227 / Arg / Clr - 28mm(6mm-6mm)											
	0.221	0.630	0.224					ARG90	0.020(#2)	CL	A1-D	T
	U-Factor 0.48			SHGC(>1) 0.14				VT(>1) 0.28		CR 53		
558	Outswing - 2 Vertical TDLS: ClimaGuard Premium T / Arg / Clr - 27mm(6mm-5mm)											
	0.230	0.630	0.185					ARG90	0.035(#2)	CL	A1-D	T
	U-Factor 0.48			SHGC(>1) 0.25				VT(>1) 0.35		CR 53		
559	Outswing - 2 Vertical TDLS: SN 4023 / Arg / Clr - 27mm(6mm-5mm)											
	0.230	0.630	0.185					ARG90	0.026(#2)	CL	A1-D	T
	U-Factor 0.47			SHGC(>1) 0.12				VT(>1) 0.18		CR 53		
560	Outswing - 2 Vertical TDLS: SN 5128 / Arg / Clr - 27mm(6mm-5mm)											
	0.230	0.630	0.185					ARG90	0.025(#2)	CL	A1-D	T
	U-Factor 0.47			SHGC(>1) 0.14				VT(>1) 0.23		CR 53		

TEST REPORT FOR NEON ENERGY USA INC.

Report No: K0461.02-301-45 R3

Date: 12/18/20

SECTION 6 (Continued)

SIMULATION RESULTS

TOTAL PRODUCT CALCULATIONS (Ultra Outswing and Inswing Door)												
Option Number	Pane Thickness 1 (in)	Gap Width 1 (in)	Pane Thickness 2 (in)	Gap Width 2 (in)	Pane Thickness 3 (in)	Gap Width 3 (in)	Pane Thickness 4 (in)	Gap Fill	Low-e (Surface #)	Tint	Spacer	Grid Type
	U-Factor (Btu/Hr-Ft2-F)			Solar Heat Gain Coefficient (SHGC) Grids (None / <1 / >=1)				Visible Transmittance (VT) Grids (None / <1 / >=1)		Condensation Resistance (CR)		
561	Outswing - 2 Vertical TDs: SN 6234 / Arg / Clr - 27mm(6mm-5mm)											
	0.230	0.630	0.185					ARG90	0.026(#2)	CL	A1-D	T
	U-Factor 0.47			SHGC(>1) 0.16				VT(>1) 0.29		CR 53		
562	Outswing - 2 Vertical TDs: SN 7037 / Arg / Clr - 27mm(6mm-5mm)											
	0.230	0.630	0.185					ARG90	0.022(#2)	CL	A1-D	T
	U-Factor 0.47			SHGC(>1) 0.18				VT(>1) 0.32		CR 53		
563	Outswing - 2 Vertical TDs: ClimaGuard Neutral 70 / Arg / Clr - 27mm(6mm-5mm)											
	0.226	0.630	0.185					ARG90	0.171(#2)	CL	A1-D	T
	U-Factor 0.50			SHGC(>1) 0.27				VT(>1) 0.31		CR 52		
564	Outswing - 2 Vertical TDs: SNX 6227 / Arg / Clr - 24mm(4mm-4mm)											
	0.151	0.630	0.154					ARG90	0.020(#2)	CL	A1-D	T
	U-Factor 0.47			SHGC(>1) 0.14				VT(>1) 0.29		CR 53		
565	Outswing - 2 Vertical TDs: ClimaGuard Premium T / Arg / Clr - 24mm(4mm-4mm)											
	0.151	0.630	0.154					ARG90	0.035(#2)	CL	A1-D	T
	U-Factor 0.47			SHGC(>1) 0.26				VT(>1) 0.36		CR 53		
566	Outswing - 2 Vertical TDs: SN 4023 / Arg / Clr - 24mm(4mm-4mm)											
	0.151	0.630	0.154					ARG90	0.026(#2)	CL	A1-D	T
	U-Factor 0.47			SHGC(>1) 0.12				VT(>1) 0.19		CR 53		
567	Outswing - 2 Vertical TDs: SN 5128 / Arg / Clr - 24mm(4mm-4mm)											
	0.151	0.630	0.154					ARG90	0.025(#2)	CL	A1-D	T
	U-Factor 0.47			SHGC(>1) 0.14				VT(>1) 0.24		CR 53		
568	Outswing - 2 Vertical TDs: SN 6234 / Arg / Clr - 24mm(4mm-4mm)											
	0.151	0.630	0.154					ARG90	0.026(#2)	CL	A1-D	T
	U-Factor 0.47			SHGC(>1) 0.16				VT(>1) 0.29		CR 53		
569	Outswing - 2 Vertical TDs: SN 7037 / Arg / Clr - 24mm(4mm-4mm)											
	0.151	0.630	0.154					ARG90	0.022(#2)	CL	A1-D	T
	U-Factor 0.47			SHGC(>1) 0.18				VT(>1) 0.32		CR 53		
570	Outswing - 2 Vertical TDs: ClimaGuard Neutral 70 / Arg / Clr - 24mm(4mm-4mm)											
	0.148	0.630	0.154					ARG90	0.171(#2)	CL	A1-D	T
	U-Factor 0.50			SHGC(>1) 0.28				VT(>1) 0.32		CR 53		

TEST REPORT FOR NEON ENERGY USA INC.

Report No: K0461.02-301-45 R3

Date: 12/18/20

SECTION 6 (Continued) SIMULATION RESULTS

TOTAL PRODUCT CALCULATIONS (Ultra Outswing and Inswing Door)												
Option Number	Pane Thickness 1 (in)	Gap Width 1 (in)	Pane Thickness 2 (in)	Gap Width 2 (in)	Pane Thickness 3 (in)	Gap Width 3 (in)	Pane Thickness 4 (in)	Gap Fill	Low-e (Surface #)	Tint	Spacer	Grid Type
	U-Factor (Btu/Hr-Ft2-F)			Solar Heat Gain Coefficient (SHGC) Grids (None / <1 / >=1)				Visible Transmittance (VT) Grids (None / <1 / >=1)		Condensation Resistance (CR)		
571	Outswing - 2 Vertical TDs: ClimaGuard Neutral 70 / Arg / Clr - 28mm(6mm-5mm)											
	0.226	0.670	0.185					ARG90	0.171(#2)	CL	A1-D	T
	U-Factor 0.50			SHGC(>1) 0.27				VT(>1) 0.31		CR 52		
572	Outswing - 2 Vertical TDs: ClimaGuard Neutral 70 / Arg / Clr - 28mm(4mm-4mm)											
	0.226	0.787	0.185					ARG90	0.171(#2)	CL	A1-D	T
	U-Factor 0.51			SHGC(>1) 0.27				VT(>1) 0.31		CR 51		
573	Outswing - 2 Vertical TDs: SNX 5123 / Arg / 3mmClr-030PVB-3mmIS20 - 28mm (6mm-6mm)											
	0.221	0.625	0.264					ARG90	0.021(#2) / 0.198(#4)	CL	TS-D	T
	U-Factor 0.40			SHGC(>1) 0.12				VT(>1) 0.23		CR 51		
574	Outswing - 3 Vertical TDs: SNX 5123 / Arg / Clr - 28mm(6mm-6mm)											
	0.221	0.630	0.224					ARG90	0.021(#2)	CL	A1-D	T
	U-Factor 0.52			SHGC(>1) 0.12				VT(>1) 0.24		CR 49		
575	Outswing - 3 Vertical TDs: SNX 6227 / Arg / Clr - 28mm(6mm-6mm)											
	0.221	0.630	0.224					ARG90	0.020(#2)	CL	A1-D	T
	U-Factor 0.52			SHGC(>1) 0.14				VT(>1) 0.28		CR 49		
576	Outswing - 3 Vertical TDs: ClimaGuard Premium T / Arg / Clr - 27mm(6mm-5mm)											
	0.230	0.630	0.185					ARG90	0.035(#2)	CL	A1-D	T
	U-Factor 0.52			SHGC(>1) 0.25				VT(>1) 0.35		CR 49		
577	Outswing - 3 Vertical TDs: SN 4023 / Arg / Clr - 27mm(6mm-5mm)											
	0.230	0.630	0.185					ARG90	0.026(#2)	CL	A1-D	T
	U-Factor 0.51			SHGC(>1) 0.12				VT(>1) 0.18		CR 49		
578	Outswing - 3 Vertical TDs: SN 5128 / Arg / Clr - 27mm(6mm-5mm)											
	0.230	0.630	0.185					ARG90	0.025(#2)	CL	A1-D	T
	U-Factor 0.51			SHGC(>1) 0.14				VT(>1) 0.23		CR 49		
579	Outswing - 3 Vertical TDs: SN 6234 / Arg / Clr - 27mm(6mm-5mm)											
	0.230	0.630	0.185					ARG90	0.026(#2)	CL	A1-D	T
	U-Factor 0.51			SHGC(>1) 0.16				VT(>1) 0.29		CR 49		
580	Outswing - 3 Vertical TDs: SN 7037 / Arg / Clr - 27mm(6mm-5mm)											
	0.230	0.630	0.185					ARG90	0.022(#2)	CL	A1-D	T
	U-Factor 0.51			SHGC(>1) 0.18				VT(>1) 0.32		CR 49		

TEST REPORT FOR NEON ENERGY USA INC.

Report No: K0461.02-301-45 R3

Date: 12/18/20

SECTION 6 (Continued) SIMULATION RESULTS

TOTAL PRODUCT CALCULATIONS (Ultra Outswing and Inswing Door)												
Option Number	Pane Thickness 1 (in)	Gap Width 1 (in)	Pane Thickness 2 (in)	Gap Width 2 (in)	Pane Thickness 3 (in)	Gap Width 3 (in)	Pane Thickness 4 (in)	Gap Fill	Low-e (Surface #)	Tint	Spacer	Grid Type
	U-Factor (Btu/Hr-Ft2-F)			Solar Heat Gain Coefficient (SHGC) Grids (None / <1 / >=1)				Visible Transmittance (VT) Grids (None / <1 / >=1)		Condensation Resistance (CR)		
581	Outswing - 3 Vertical TDLs: ClimaGuard Neutral 70 / Arg / Clr - 27mm(6mm-5mm)											
	0.226	0.630	0.185					ARG90	0.171(#2)	CL	A1-D	T
	U-Factor 0.53			SHGC(>1) 0.27				VT(>1) 0.31		CR 47		
582	Outswing - 3 Vertical TDLs: SNX 6227 / Arg / Clr - 24mm(4mm-4mm)											
	0.151	0.630	0.154					ARG90	0.020(#2)	CL	A1-D	T
	U-Factor 0.51			SHGC(>1) 0.14				VT(>1) 0.29		CR 50		
583	Outswing - 3 Vertical TDLs: ClimaGuard Premium T / Arg / Clr - 24mm(4mm-4mm)											
	0.151	0.630	0.154					ARG90	0.035(#2)	CL	A1-D	T
	U-Factor 0.51			SHGC(>1) 0.26				VT(>1) 0.36		CR 50		
584	Outswing - 3 Vertical TDLs: SN 4023 / Arg / Clr - 24mm(4mm-4mm)											
	0.151	0.630	0.154					ARG90	0.026(#2)	CL	A1-D	T
	U-Factor 0.51			SHGC(>1) 0.12				VT(>1) 0.19		CR 50		
585	Outswing - 3 Vertical TDLs: SN 5128 / Arg / Clr - 24mm(4mm-4mm)											
	0.151	0.630	0.154					ARG90	0.025(#2)	CL	A1-D	T
	U-Factor 0.51			SHGC(>1) 0.14				VT(>1) 0.24		CR 50		
586	Outswing - 3 Vertical TDLs: SN 6234 / Arg / Clr - 24mm(4mm-4mm)											
	0.151	0.630	0.154					ARG90	0.026(#2)	CL	A1-D	T
	U-Factor 0.51			SHGC(>1) 0.16				VT(>1) 0.29		CR 50		
587	Outswing - 3 Vertical TDLs: SN 7037 / Arg / Clr - 24mm(4mm-4mm)											
	0.151	0.630	0.154					ARG90	0.022(#2)	CL	A1-D	T
	U-Factor 0.51			SHGC(>1) 0.18				VT(>1) 0.32		CR 50		
588	Outswing - 3 Vertical TDLs: ClimaGuard Neutral 70 / Arg / Clr - 24mm(4mm-4mm)											
	0.148	0.630	0.154					ARG90	0.171(#2)	CL	A1-D	T
	U-Factor 0.53			SHGC(>1) 0.28				VT(>1) 0.32		CR 49		
589	Outswing - 3 Vertical TDLs: ClimaGuard Neutral 70 / Arg / Clr - 28mm(6mm-5mm)											
	0.226	0.670	0.185					ARG90	0.171(#2)	CL	A1-D	T
	U-Factor 0.54			SHGC(>1) 0.27				VT(>1) 0.31		CR 47		
590	Outswing - 3 Vertical TDLs: ClimaGuard Neutral 70 / Arg / Clr - 28mm(4mm-4mm)											
	0.226	0.787	0.185					ARG90	0.171(#2)	CL	A1-D	T
	U-Factor 0.55			SHGC(>1) 0.27				VT(>1) 0.31		CR 46		

TEST REPORT FOR NEON ENERGY USA INC.

Report No: K0461.02-301-45 R3

Date: 12/18/20

SECTION 6 (Continued)

SIMULATION RESULTS

TOTAL PRODUCT CALCULATIONS (Ultra Outswing and Inswing Door)												
Option Number	Pane Thickness 1 (in)	Gap Width 1 (in)	Pane Thickness 2 (in)	Gap Width 2 (in)	Pane Thickness 3 (in)	Gap Width 3 (in)	Pane Thickness 4 (in)	Gap Fill	Low-e (Surface #)	Tint	Spacer	Grid Type
	U-Factor (Btu/Hr-Ft ² -F)			Solar Heat Gain Coefficient (SHGC) Grids (None / <1 / >=1)				Visible Transmittance (VT) Grids (None / <1 / >=1)		Condensation Resistance (CR)		
591	Outswing - 3 Vertical TDs: SNX 5123 / Arg / 3mmClr-030PVB-3mmIS20 - 28mm (6mm-6mm)											
	0.221	0.625	0.264					ARG90	0.021(#2) / 0.198(#4)	CL	TS-D	T
	U-Factor 0.43			SHGC(>1) 0.12				VT(>1) 0.23		CR 51		
592	Outswing - 4 Vertical TDs: SNX 5123 / Arg / Clr - 28mm(6mm-6mm)											
	0.221	0.630	0.224					ARG90	0.021(#2)	CL	A1-D	T
	U-Factor 0.59			SHGC(>1) 0.12				VT(>1) 0.24		CR 48		
593	Outswing - 4 Vertical TDs: SNX 6227 / Arg / Clr - 28mm(6mm-6mm)											
	0.221	0.630	0.224					ARG90	0.020(#2)	CL	A1-D	T
	U-Factor 0.59			SHGC(>1) 0.14				VT(>1) 0.28		CR 48		
594	Outswing - 4 Vertical TDs: ClimaGuard Premium T / Arg / Clr - 27mm(6mm-5mm)											
	0.230	0.630	0.185					ARG90	0.035(#2)	CL	A1-D	T
	U-Factor 0.59			SHGC(>1) 0.25				VT(>1) 0.35		CR 48		
595	Outswing - 4 Vertical TDs: SN 4023 / Arg / Clr - 27mm(6mm-5mm)											
	0.230	0.630	0.185					ARG90	0.026(#2)	CL	A1-D	T
	U-Factor 0.58			SHGC(>1) 0.12				VT(>1) 0.18		CR 48		
596	Outswing - 4 Vertical TDs: SN 5128 / Arg / Clr - 27mm(6mm-5mm)											
	0.230	0.630	0.185					ARG90	0.025(#2)	CL	A1-D	T
	U-Factor 0.58			SHGC(>1) 0.14				VT(>1) 0.23		CR 48		
597	Outswing - 4 Vertical TDs: SN 6234 / Arg / Clr - 27mm(6mm-5mm)											
	0.230	0.630	0.185					ARG90	0.026(#2)	CL	A1-D	T
	U-Factor 0.58			SHGC(>1) 0.16				VT(>1) 0.29		CR 48		
598	Outswing - 4 Vertical TDs: SN 7037 / Arg / Clr - 27mm(6mm-5mm)											
	0.230	0.630	0.185					ARG90	0.022(#2)	CL	A1-D	T
	U-Factor 0.58			SHGC(>1) 0.18				VT(>1) 0.32		CR 49		
599	Outswing - 4 Vertical TDs: ClimaGuard Neutral 70 / Arg / Clr - 27mm(6mm-5mm)											
	0.226	0.630	0.185					ARG90	0.171(#2)	CL	A1-D	T
	U-Factor 0.61			SHGC(>1) 0.27				VT(>1) 0.31		CR 47		
600	Outswing - 4 Vertical TDs: SNX 6227 / Arg / Clr - 24mm(4mm-4mm)											
	0.151	0.630	0.154					ARG90	0.020(#2)	CL	A1-D	T
	U-Factor 0.58			SHGC(>1) 0.14				VT(>1) 0.29		CR 50		

TEST REPORT FOR NEON ENERGY USA INC.

Report No: K0461.02-301-45 R3

Date: 12/18/20

SECTION 6 (Continued)

SIMULATION RESULTS

TOTAL PRODUCT CALCULATIONS (Ultra Outswing and Inswing Door)												
Option Number	Pane Thickness 1 (in)	Gap Width 1 (in)	Pane Thickness 2 (in)	Gap Width 2 (in)	Pane Thickness 3 (in)	Gap Width 3 (in)	Pane Thickness 4 (in)	Gap Fill	Low-e (Surface #)	Tint	Spacer	Grid Type
	U-Factor (Btu/Hr-Ft2-F)			Solar Heat Gain Coefficient (SHGC) Grids (None / <1 / >=1)				Visible Transmittance (VT) Grids (None / <1 / >=1)		Condensation Resistance (CR)		
601	Outswing - 4 Vertical TDs: ClimaGuard Premium T / Arg / Clr - 24mm(4mm-4mm)											
	0.151	0.630	0.154					ARG90	0.035(#2)	CL	A1-D	T
	U-Factor 0.58			SHGC(>1) 0.26				VT(>1) 0.36		CR 50		
602	Outswing - 4 Vertical TDs: SN 4023 / Arg / Clr - 24mm(4mm-4mm)											
	0.151	0.630	0.154					ARG90	0.026(#2)	CL	A1-D	T
	U-Factor 0.58			SHGC(>1) 0.12				VT(>1) 0.19		CR 50		
603	Outswing - 4 Vertical TDs: SN 5128 / Arg / Clr - 24mm(4mm-4mm)											
	0.151	0.630	0.154					ARG90	0.025(#2)	CL	A1-D	T
	U-Factor 0.58			SHGC(>1) 0.14				VT(>1) 0.24		CR 50		
604	Outswing - 4 Vertical TDs: SN 6234 / Arg / Clr - 24mm(4mm-4mm)											
	0.151	0.630	0.154					ARG90	0.026(#2)	CL	A1-D	T
	U-Factor 0.58			SHGC(>1) 0.16				VT(>1) 0.29		CR 50		
605	Outswing - 4 Vertical TDs: SN 7037 / Arg / Clr - 24mm(4mm-4mm)											
	0.151	0.630	0.154					ARG90	0.022(#2)	CL	A1-D	T
	U-Factor 0.58			SHGC(>1) 0.18				VT(>1) 0.32		CR 50		
606	Outswing - 4 Vertical TDs: ClimaGuard Neutral 70 / Arg / Clr - 24mm(4mm-4mm)											
	0.148	0.630	0.154					ARG90	0.171(#2)	CL	A1-D	T
	U-Factor 0.60			SHGC(>1) 0.28				VT(>1) 0.32		CR 48		
607	Outswing - 4 Vertical TDs: ClimaGuard Neutral 70 / Arg / Clr - 28mm(6mm-5mm)											
	0.226	0.670	0.185					ARG90	0.171(#2)	CL	A1-D	T
	U-Factor 0.61			SHGC(>1) 0.27				VT(>1) 0.31		CR 47		
608	Outswing - 4 Vertical TDs: ClimaGuard Neutral 70 / Arg / Clr - 28mm(4mm-4mm)											
	0.226	0.787	0.185					ARG90	0.171(#2)	CL	A1-D	T
	U-Factor 0.63			SHGC(>1) 0.27				VT(>1) 0.31		CR 45		
609	Outswing - 4 Vertical TDs: SNX 5123 / Arg / 3mmClr-030PVB-3mmIS20 - 28mm (6mm-6mm)											
	0.221	0.625	0.264					ARG90	0.021(#2) / 0.198(#4)	CL	TS-D	T
	U-Factor 0.48			SHGC(>1) 0.12				VT(>1) 0.23		CR 51		
610	Outswing: SN 5128 / Arg / Climaguard Dry - 27mm(6mm-6mm)											
	0.230	0.590	0.230					ARG90	0.025(#2) / 0.200(#4)	CL	TP-D	N
	U-Factor 0.35			SHGC(N) 0.17				VT(N) 0.31		CR 51		

TEST REPORT FOR NEON ENERGY USA INC.

Report No: K0461.02-301-45 R3

Date: 12/18/20

SECTION 6 (Continued)

SIMULATION RESULTS

TOTAL PRODUCT CALCULATIONS (Ultra Outswing and Inswing Door)												
Option Number	Pane Thickness 1 (in)	Gap Width 1 (in)	Pane Thickness 2 (in)	Gap Width 2 (in)	Pane Thickness 3 (in)	Gap Width 3 (in)	Pane Thickness 4 (in)	Gap Fill	Low-e (Surface #)	Tint	Spacer	Grid Type
	U-Factor (Btu/Hr-Ft ² -F)			Solar Heat Gain Coefficient (SHGC) Grids (None / <1 / >=1)				Visible Transmittance (VT) Grids (None / <1 / >=1)		Condensation Resistance (CR)		
611	Outswing - SN 5128 / Arg / ClimaGurad Dry - 27mm(6mm-6mm): SN 5128 / Arg / ClimaGuard Dry - 27mm(6mm-6mm)											
	0.230	0.590	0.230					ARG90	0.025(#2) / 0.200(#4)	CL	TP-D	T
	U-Factor 0.45			SHGC(>1) 0.13				VT(>1) 0.23		CR 51		
612	Outswing - 1 Horizontal TDL: SN 5128 / Arg / ClimaGuard Dry - 27mm(6mm-6mm)											
	0.230	0.590	0.230					ARG90	0.025(#2) / 0.200(#4)	CL	TP-D	T
	U-Factor 0.35			SHGC(>1) 0.13				VT(>1) 0.23		CR 51		
613	Outswing - 2 Horizontal TDLs: SN 5128 / Arg / ClimaGuard Dry - 27mm(6mm-6mm)											
	0.230	0.590	0.230					ARG90	0.025(#2) / 0.200(#4)	CL	TP-D	T
	U-Factor 0.36			SHGC(>1) 0.13				VT(>1) 0.23		CR 51		
614	Outswing - 3 Horizontal TDLs: SN 5128 / Arg / ClimaGuard Dry - 27mm(6mm-6mm)											
	0.230	0.590	0.230					ARG90	0.025(#2) / 0.200(#4)	CL	TP-D	T
	U-Factor 0.37			SHGC(>1) 0.13				VT(>1) 0.23		CR 51		
615	Outswing - 4 Horizontal TDLs: SN 5128 / Arg / ClimaGuard Dry - 27mm(6mm-6mm)											
	0.230	0.590	0.230					ARG90	0.025(#2) / 0.200(#4)	CL	TP-D	T
	U-Factor 0.38			SHGC(>1) 0.13				VT(>1) 0.23		CR 51		
616	Outswing - 1 Vertical TDL: SN 5128 / Arg / ClimaGuard Dry - 27mm(6mm-6mm)											
	0.230	0.590	0.230					ARG90	0.025(#2) / 0.200(#4)	CL	TP-D	T
	U-Factor 0.37			SHGC(>1) 0.13				VT(>1) 0.23		CR 51		
617	Outswing - 2 Vertical TDLs: SN 5128 / Arg / ClimaGuard Dry - 27mm(6mm-6mm)											
	0.230	0.590	0.230					ARG90	0.025(#2) / 0.200(#4)	CL	TP-D	T
	U-Factor 0.39			SHGC(>1) 0.13				VT(>1) 0.23		CR 51		
618	Outswing - 3 Vertical TDLs: SN 5128 / Arg / ClimaGuard Dry - 27mm(6mm-6mm)											
	0.230	0.590	0.230					ARG90	0.025(#2) / 0.200(#4)	CL	TP-D	T
	U-Factor 0.41			SHGC(>1) 0.13				VT(>1) 0.23		CR 51		
619	Outswing - 4 Vertical TDLs: SN 5128 / Arg / ClimaGuard Dry - 27mm(6mm-6mm)											
	0.230	0.590	0.230					ARG90	0.025(#2) / 0.200(#4)	CL	TP-D	T
	U-Factor 0.46			SHGC(>1) 0.13				VT(>1) 0.23		CR 51		
620	Outswing: SN 5128 / Arg / IS20 - 27mm(6mm-6mm)											
	0.230	0.590	0.221					ARG90	0.025(#2) / 0.198(#4)	CL	TP-D	N
	U-Factor 0.34			SHGC(N) 0.17				VT(N) 0.31		CR 51		

TEST REPORT FOR NEON ENERGY USA INC.

Report No: K0461.02-301-45 R3

Date: 12/18/20

SECTION 6 (Continued)

SIMULATION RESULTS

TOTAL PRODUCT CALCULATIONS (Ultra Outswing and Inswing Door)												
Option Number	Pane Thickness 1 (in)	Gap Width 1 (in)	Pane Thickness 2 (in)	Gap Width 2 (in)	Pane Thickness 3 (in)	Gap Width 3 (in)	Pane Thickness 4 (in)	Gap Fill	Low-e (Surface #)	Tint	Spacer	Grid Type
	U-Factor (Btu/Hr-Ft ² -F)			Solar Heat Gain Coefficient (SHGC) Grids (None / <1 / >=1)				Visible Transmittance (VT) Grids (None / <1 / >=1)		Condensation Resistance (CR)		
621	Outswing - SN 5128 / Arg / IS20 - 27mm(6mm-6mm): SN 5128 / Arg / IS20 - 27mm(6mm-6mm)											
	0.230	0.590	0.221					ARG90	0.025(#2) / 0.198(#4)	CL	TP-D	T
	U-Factor 0.45			SHGC(>1) 0.13				VT(>1) 0.23		CR 51		
622	Outswing - 1 Horizontal TD: SN 5128 / Arg / IS20 - 27mm(6mm-6mm)											
	0.230	0.590	0.221					ARG90	0.025(#2) / 0.198(#4)	CL	TP-D	T
	U-Factor 0.35			SHGC(>1) 0.13				VT(>1) 0.23		CR 51		
623	Outswing - 2 Horizontal TDs: SN 5128 / Arg / IS20 - 27mm(6mm-6mm)											
	0.230	0.590	0.221					ARG90	0.025(#2) / 0.198(#4)	CL	TP-D	T
	U-Factor 0.36			SHGC(>1) 0.13				VT(>1) 0.23		CR 51		
624	Outswing - 3 Horizontal TDs: SN 5128 / Arg / IS20 - 27mm(6mm-6mm)											
	0.230	0.590	0.221					ARG90	0.025(#2) / 0.198(#4)	CL	TP-D	T
	U-Factor 0.37			SHGC(>1) 0.13				VT(>1) 0.23		CR 51		
625	Outswing - 4 Horizontal TDs: SN 5128 / Arg / IS20 - 27mm(6mm-6mm)											
	0.230	0.590	0.221					ARG90	0.025(#2) / 0.198(#4)	CL	TP-D	T
	U-Factor 0.38			SHGC(>1) 0.13				VT(>1) 0.23		CR 51		
626	Outswing - 1 Vertical TD: SN 5128 / Arg / IS20 - 27mm(6mm-6mm)											
	0.230	0.590	0.221					ARG90	0.025(#2) / 0.198(#4)	CL	TP-D	T
	U-Factor 0.37			SHGC(>1) 0.13				VT(>1) 0.23		CR 51		
627	Outswing - 2 Vertical TDs: SN 5128 / Arg / IS20 - 27mm(6mm-6mm)											
	0.230	0.590	0.221					ARG90	0.025(#2) / 0.198(#4)	CL	TP-D	T
	U-Factor 0.39			SHGC(>1) 0.13				VT(>1) 0.23		CR 51		
628	Outswing - 3 Vertical TDs: SN 5128 / Arg / IS20 - 27mm(6mm-6mm)											
	0.230	0.590	0.221					ARG90	0.025(#2) / 0.198(#4)	CL	TP-D	T
	U-Factor 0.41			SHGC(>1) 0.13				VT(>1) 0.23		CR 51		
629	Outswing - 4 Vertical TDs: SN 5128 / Arg / IS20 - 27mm(6mm-6mm)											
	0.230	0.590	0.221					ARG90	0.025(#2) / 0.198(#4)	CL	TP-D	T
	U-Factor 0.46			SHGC(>1) 0.13				VT(>1) 0.23		CR 51		
630	Outswing: 4mm-076PVB-4mmPlanistar / Arg / 3mmClr-076PVB-3mmClr - 28mm(8mm-6mm)											
	0.384	0.391	0.311					ARG90	0.026(#2)	CL	A1-D	N
	U-Factor 0.38			SHGC(N) 0.22				VT(N) 0.43		CR 53		

TEST REPORT FOR NEON ENERGY USA INC.

Report No: K0461.02-301-45 R3

Date: 12/18/20

SECTION 6 (Continued)

SIMULATION RESULTS

TOTAL PRODUCT CALCULATIONS (Ultra Outswing and Inswing Door)												
Option Number	Pane Thickness 1 (in)	Gap Width 1 (in)	Pane Thickness 2 (in)	Gap Width 2 (in)	Pane Thickness 3 (in)	Gap Width 3 (in)	Pane Thickness 4 (in)	Gap Fill	Low-e (Surface #)	Tint	Spacer	Grid Type
	U-Factor (Btu/Hr-Ft2-F)			Solar Heat Gain Coefficient (SHGC) Grids (None / <1 / >=1)				Visible Transmittance (VT) Grids (None / <1 / >=1)		Condensation Resistance (CR)		
631	Outswing - 4mm-076PVB-4mmPlanistar / Arg / 3mmClr-076PVB-3mmClr - 28mm(8mm-6mm): 4mm-076PVB-4mmPlanistar / Arg / 3mmClr-076PVB-3mmClr - 28mm(8mm-6mm)											
	0.384	0.391	0.311					ARG90	0.026(#2)	CL	A1-D	T
	U-Factor 0.53			SHGC(>1) 0.17				VT(>1) 0.31		CR 51		
632	Outswing - 1 Horizontal TDL: 4mm-076PVB-4mmPlanistar / Arg / 3mmClr-076PVB-3mmClr - 28mm(8mm-6mm)											
	0.384	0.391	0.311					ARG90	0.026(#2)	CL	A1-D	T
	U-Factor 0.40			SHGC(>1) 0.17				VT(>1) 0.31		CR 53		
633	Outswing - 2 Horizontal TDLS: 4mm-076PVB-4mmPlanistar / Arg / 3mmClr-076PVB-3mmClr - 28mm(8mm-6mm)											
	0.384	0.391	0.311					ARG90	0.026(#2)	CL	A1-D	T
	U-Factor 0.41			SHGC(>1) 0.17				VT(>1) 0.31		CR 53		
634	Outswing - 3 Horizontal TDLS: 4mm-076PVB-4mmPlanistar / Arg / 3mmClr-076PVB-3mmClr - 28mm(8mm-6mm)											
	0.384	0.391	0.311					ARG90	0.026(#2)	CL	A1-D	T
	U-Factor 0.42			SHGC(>1) 0.17				VT(>1) 0.31		CR 53		
635	Outswing - 4 Horizontal TDLS: 4mm-076PVB-4mmPlanistar / Arg / 3mmClr-076PVB-3mmClr - 28mm(8mm-6mm)											
	0.384	0.391	0.311					ARG90	0.026(#2)	CL	A1-D	T
	U-Factor 0.44			SHGC(>1) 0.17				VT(>1) 0.31		CR 53		
636	Outswing - 1 Vertical TDL: 4mm-076PVB-4mmPlanistar / Arg / 3mmClr-076PVB-3mmClr - 28mm(8mm-6mm)											
	0.384	0.391	0.311					ARG90	0.026(#2)	CL	A1-D	T
	U-Factor 0.42			SHGC(>1) 0.17				VT(>1) 0.31		CR 53		
637	Outswing - 2 Vertical TDLS: 4mm-076PVB-4mmPlanistar / Arg / 3mmClr-076PVB-3mmClr - 28mm(8mm-6mm)											
	0.384	0.391	0.311					ARG90	0.026(#2)	CL	A1-D	T
	U-Factor 0.45			SHGC(>1) 0.17				VT(>1) 0.31		CR 53		
638	Outswing - 3 Vertical TDLS: 4mm-076PVB-4mmPlanistar / Arg / 3mmClr-076PVB-3mmClr - 28mm(8mm-6mm)											
	0.384	0.391	0.311					ARG90	0.026(#2)	CL	A1-D	T
	U-Factor 0.49			SHGC(>1) 0.17				VT(>1) 0.31		CR 53		
639	Outswing - 4 Vertical TDLS: 4mm-076PVB-4mmPlanistar / Arg / 3mmClr-076PVB-3mmClr - 28mm(8mm-6mm)											
	0.384	0.391	0.311					ARG90	0.026(#2)	CL	A1-D	T
	U-Factor 0.55			SHGC(>1) 0.17				VT(>1) 0.31		CR 52		
640	Outswing w/ Kickplate: SNX 5123 / Arg / Clr - 28mm(6mm-6mm)											
	0.221	0.630	0.224					ARG90	0.021(#2)	CL	A1-D	N
	U-Factor 0.42			SHGC(N) 0.15				VT(N) 0.29		CR 50		

TEST REPORT FOR NEON ENERGY USA INC.

Report No: K0461.02-301-45 R3

Date: 12/18/20

SECTION 6 (Continued)

SIMULATION RESULTS

TOTAL PRODUCT CALCULATIONS (Ultra Outswing and Inswing Door)												
Option Number	Pane Thickness 1 (in)	Gap Width 1 (in)	Pane Thickness 2 (in)	Gap Width 2 (in)	Pane Thickness 3 (in)	Gap Width 3 (in)	Pane Thickness 4 (in)	Gap Fill	Low-e (Surface #)	Tint	Spacer	Grid Type
	U-Factor (Btu/Hr-Ft ² -F)			Solar Heat Gain Coefficient (SHGC) Grids (None / <1 / >=1)				Visible Transmittance (VT) Grids (None / <1 / >=1)		Condensation Resistance (CR)		
641	Outswing w/ Kickplate - NFRC Default: SNX 5123 / Arg / Clr - 28mm(6mm-6mm)											
	0.221	0.630	0.224					ARG90	0.021(#2)	CL	A1-D	T
	U-Factor 0.58			SHGC(>1) 0.12				VT(>1) 0.21		CR 47		
642	Outswing w/ Kickplate: SNX 6227 / Arg / Clr - 28mm(6mm-6mm)											
	0.221	0.630	0.224					ARG90	0.020(#2)	CL	A1-D	N
	U-Factor 0.42			SHGC(N) 0.17				VT(N) 0.36		CR 50		
643	Outswing w/ Kickplate - NFRC Default: SNX 6227 / Arg / Clr - 28mm(6mm-6mm)											
	0.221	0.630	0.224					ARG90	0.020(#2)	CL	A1-D	T
	U-Factor 0.58			SHGC(>1) 0.13				VT(>1) 0.26		CR 47		
644	Outswing w/ Kickplate: ClimaGuard Premium T / Arg / Clr - 27mm(6mm-5mm)											
	0.230	0.630	0.185					ARG90	0.035(#2)	CL	A1-D	N
	U-Factor 0.43			SHGC(N) 0.31				VT(N) 0.44		CR 50		
645	Outswing w/ Kickplate - NFRC Default: ClimaGuard Premium T / Arg / Clr - 27mm(6mm-5mm)											
	0.230	0.630	0.185					ARG90	0.035(#2)	CL	A1-D	T
	U-Factor 0.58			SHGC(>1) 0.23				VT(>1) 0.32		CR 47		
646	Outswing w/ Kickplate: SN 4023 / Arg / Clr - 27mm(6mm-5mm)											
	0.230	0.630	0.185					ARG90	0.026(#2)	CL	A1-D	N
	U-Factor 0.42			SHGC(N) 0.14				VT(N) 0.23		CR 50		
647	Outswing w/ Kickplate - NFRC Default: SN 4023 / Arg / Clr - 27mm(6mm-5mm)											
	0.230	0.630	0.185					ARG90	0.026(#2)	CL	A1-D	T
	U-Factor 0.58			SHGC(>1) 0.11				VT(>1) 0.16		CR 47		
648	Outswing w/ Kickplate: SN 5128 / Arg / Clr - 27mm(6mm-5mm)											
	0.230	0.630	0.185					ARG90	0.025(#2)	CL	A1-D	N
	U-Factor 0.42			SHGC(N) 0.16				VT(N) 0.29		CR 50		
649	Outswing w/ Kickplate - NFRC Default: SN 5128 / Arg / Clr - 27mm(6mm-5mm)											
	0.230	0.630	0.185					ARG90	0.025(#2)	CL	A1-D	T
	U-Factor 0.58			SHGC(>1) 0.13				VT(>1) 0.21		CR 48		
650	Outswing w/ Kickplate: SN 6234 / Arg / Clr - 27mm(6mm-5mm)											
	0.230	0.630	0.185					ARG90	0.026(#2)	CL	A1-D	N
	U-Factor 0.42			SHGC(N) 0.19				VT(N) 0.36		CR 50		

TEST REPORT FOR NEON ENERGY USA INC.

Report No: K0461.02-301-45 R3

Date: 12/18/20

SECTION 6 (Continued)

SIMULATION RESULTS

TOTAL PRODUCT CALCULATIONS (Ultra Outswing and Inswing Door)												
Option Number	Pane Thickness 1 (in)	Gap Width 1 (in)	Pane Thickness 2 (in)	Gap Width 2 (in)	Pane Thickness 3 (in)	Gap Width 3 (in)	Pane Thickness 4 (in)	Gap Fill	Low-e (Surface #)	Tint	Spacer	Grid Type
	U-Factor (Btu/Hr-Ft2-F)			Solar Heat Gain Coefficient (SHGC) Grids (None / <1 / >=1)				Visible Transmittance (VT) Grids (None / <1 / >=1)		Condensation Resistance (CR)		
651	Outswing w/ Kickplate - NFRC Default: SN 6234 / Arg / Clr - 27mm(6mm-5mm)											
	0.230	0.630	0.185					ARG90	0.026(#2)	CL	A1-D	T
	U-Factor 0.58			SHGC(>1) 0.15				VT(>1) 0.26		CR 47		
652	Outswing w/ Kickplate: SN 7037 / Arg / Clr - 27mm(6mm-5mm)											
	0.230	0.630	0.185					ARG90	0.022(#2)	CL	A1-D	N
	U-Factor 0.42			SHGC(N) 0.21				VT(N) 0.40		CR 50		
653	Outswing w/ Kickplate - NFRC Default: SN 7037 / Arg / Clr - 27mm(6mm-5mm)											
	0.230	0.630	0.185					ARG90	0.022(#2)	CL	A1-D	T
	U-Factor 0.58			SHGC(>1) 0.17				VT(>1) 0.29		CR 48		
654	Outswing w/ Kickplate: ClimaGuard Neutral 70 / Arg / Clr - 27mm(6mm-5mm)											
	0.226	0.630	0.185					ARG90	0.171(#2)	CL	A1-D	N
	U-Factor 0.45			SHGC(N) 0.33				VT(N) 0.39		CR 49		
655	Outswing w/ Kickplate - NFRC Default: ClimaGuard Neutral 70 / Arg / Clr - 27mm(6mm-5mm)											
	0.226	0.630	0.185					ARG90	0.171(#2)	CL	A1-D	T
	U-Factor 0.60			SHGC(>1) 0.25				VT(>1) 0.28		CR 46		
656	Outswing w/ Kickplate: SNX 6227 / Arg / Clr - 24mm(4mm-4mm)											
	0.151	0.630	0.154					ARG90	0.020(#2)	CL	A1-D	N
	U-Factor 0.43			SHGC(N) 0.17				VT(N) 0.36		CR 50		
657	Outswing w/ Kickplate - NFRC Default: SNX 6227 / Arg / Clr - 24mm(4mm-4mm)											
	0.151	0.630	0.154					ARG90	0.020(#2)	CL	A1-D	T
	U-Factor 0.58			SHGC(>1) 0.13				VT(>1) 0.26		CR 49		
658	Outswing w/ Kickplate: ClimaGuard Premium T / Arg / Clr - 24mm(4mm-4mm)											
	0.151	0.630	0.154					ARG90	0.035(#2)	CL	A1-D	N
	U-Factor 0.43			SHGC(N) 0.31				VT(N) 0.44		CR 49		
659	Outswing w/ Kickplate - NFRC Default: ClimaGuard Premium T / Arg / Clr - 24mm(4mm-4mm)											
	0.151	0.630	0.154					ARG90	0.035(#2)	CL	A1-D	T
	U-Factor 0.58			SHGC(>1) 0.24				VT(>1) 0.32		CR 49		
660	Outswing w/ Kickplate: SN 4023 / Arg / Clr - 24mm(4mm-4mm)											
	0.151	0.630	0.154					ARG90	0.026(#2)	CL	A1-D	N
	U-Factor 0.43			SHGC(N) 0.14				VT(N) 0.23		CR 50		

TEST REPORT FOR NEON ENERGY USA INC.

Report No: K0461.02-301-45 R3

Date: 12/18/20

SECTION 6 (Continued)

SIMULATION RESULTS

TOTAL PRODUCT CALCULATIONS (Ultra Outswing and Inswing Door)												
Option Number	Pane Thickness 1 (in)	Gap Width 1 (in)	Pane Thickness 2 (in)	Gap Width 2 (in)	Pane Thickness 3 (in)	Gap Width 3 (in)	Pane Thickness 4 (in)	Gap Fill	Low-e (Surface #)	Tint	Spacer	Grid Type
	U-Factor (Btu/Hr-Ft2-F)			Solar Heat Gain Coefficient (SHGC) Grids (None / <1 / >=1)				Visible Transmittance (VT) Grids (None / <1 / >=1)		Condensation Resistance (CR)		
661	Outswing w/ Kickplate - NFRC Default: SN 4023 / Arg / Clr - 24mm(4mm-4mm)											
	0.151	0.630	0.154					ARG90	0.026(#2)	CL	A1-D	T
	U-Factor 0.58			SHGC(>1) 0.11				VT(>1) 0.17		CR 49		
662	Outswing w/ Kickplate: SN 5128 / Arg / Clr - 24mm(4mm-4mm)											
	0.151	0.630	0.154					ARG90	0.025(#2)	CL	A1-D	N
	U-Factor 0.43			SHGC(N) 0.16				VT(N) 0.29		CR 50		
663	Outswing w/ Kickplate - NFRC Default: SN 5128 / Arg / Clr - 24mm(4mm-4mm)											
	0.151	0.630	0.154					ARG90	0.025(#2)	CL	A1-D	T
	U-Factor 0.58			SHGC(>1) 0.13				VT(>1) 0.21		CR 49		
664	Outswing w/ Kickplate: SN 6234 / Arg / Clr - 24mm(4mm-4mm)											
	0.151	0.630	0.154					ARG90	0.026(#2)	CL	A1-D	N
	U-Factor 0.43			SHGC(N) 0.19				VT(N) 0.36		CR 50		
665	Outswing w/ Kickplate - NFRC Default: SN 6234 / Arg / Clr - 24mm(4mm-4mm)											
	0.151	0.630	0.154					ARG90	0.026(#2)	CL	A1-D	T
	U-Factor 0.58			SHGC(>1) 0.15				VT(>1) 0.26		CR 49		
666	Outswing w/ Kickplate: SN 7037 / Arg / Clr - 24mm(4mm-4mm)											
	0.151	0.630	0.154					ARG90	0.022(#2)	CL	A1-D	N
	U-Factor 0.43			SHGC(N) 0.22				VT(N) 0.41		CR 50		
667	Outswing w/ Kickplate - NFRC Default: SN 7037 / Arg / Clr - 24mm(4mm-4mm)											
	0.151	0.630	0.154					ARG90	0.022(#2)	CL	A1-D	T
	U-Factor 0.58			SHGC(>1) 0.17				VT(>1) 0.29		CR 49		
668	Outswing w/ Kickplate: ClimaGuard Neutral 70 / Arg / Clr - 24mm(4mm-4mm)											
	0.148	0.630	0.154					ARG90	0.171(#2)	CL	A1-D	N
	U-Factor 0.46			SHGC(N) 0.34				VT(N) 0.40		CR 49		
669	Outswing w/ Kickplate - NFRC Default: ClimaGuard Neutral 70 / Arg / Clr - 24mm(4mm-4mm)											
	0.148	0.630	0.154					ARG90	0.171(#2)	CL	A1-D	T
	U-Factor 0.59			SHGC(>1) 0.25				VT(>1) 0.29		CR 48		
670	Outswing w/ Kickplate: ClimaGuard Neutral 70 / Arg / Clr - 28mm(6mm-5mm)											
	0.226	0.670	0.185					ARG90	0.171(#2)	CL	A1-D	N
	U-Factor 0.45			SHGC(N) 0.33				VT(N) 0.39		CR 49		

TEST REPORT FOR NEON ENERGY USA INC.

Report No: K0461.02-301-45 R3

Date: 12/18/20

SECTION 6 (Continued)

SIMULATION RESULTS

TOTAL PRODUCT CALCULATIONS (Ultra Outswing and Inswing Door)												
Option Number	Pane Thickness 1 (in)	Gap Width 1 (in)	Pane Thickness 2 (in)	Gap Width 2 (in)	Pane Thickness 3 (in)	Gap Width 3 (in)	Pane Thickness 4 (in)	Gap Fill	Low-e (Surface #)	Tint	Spacer	Grid Type
	U-Factor (Btu/Hr-Ft2-F)		Solar Heat Gain Coefficient (SHGC) Grids (None / <1 / >=1)				Visible Transmittance (VT) Grids (None / <1 / >=1)		Condensation Resistance (CR)			
671	Outswing w/ Kickplate - NFRC Default: ClimaGuard Neutral 70 / Arg / Clr - 28mm(6mm-5mm)											
	0.226	0.670	0.185					ARG90	0.171(#2)	CL	A1-D	T
	U-Factor 0.60		SHGC(>1) 0.25				VT(>1) 0.28		CR 46			
672	Outswing w/ Kickplate: ClimaGuard Neutral 70 / Arg / Clr - 28mm(4mm-4mm)											
	0.226	0.787	0.185					ARG90	0.171(#2)	CL	A1-D	N
	U-Factor 0.46		SHGC(N) 0.33				VT(N) 0.39		CR 48			
673	Outswing w/ Kickplate - NFRC Default: ClimaGuard Neutral 70 / Arg / Clr - 28mm(4mm-4mm)											
	0.226	0.787	0.185					ARG90	0.171(#2)	CL	A1-D	T
	U-Factor 0.61		SHGC(>1) 0.25				VT(>1) 0.28		CR 44			
674	Outswing w/ Kickplate: SNX 6227 / Arg / SNX 6227 / Arg / Clr - 36mm(4mm-4mm-4mm)											
	0.151	0.470	0.151	0.470	0.154			ARG90	0.020(#2) / 0.020(#4)	CL	TS-D	N
	U-Factor 0.33		SHGC(N) 0.13				VT(N) 0.25		CR 51			
675	Outswing w/ Kickplate: SNX 6227 / Arg / SNX 6227 / Arg / Clr - 41mm(6mm-6mm-5mm)											
	0.221	0.470	0.221	0.470	0.185			ARG90	0.020(#2) / 0.020(#4)	CL	TS-D	N
	U-Factor 0.33		SHGC(N) 0.13				VT(N) 0.25		CR 51			
676	Outswing w/ Kickplate: SNX 5123 / Arg / SNX 5123 / Arg / Clr - 41mm(6mm-6mm-5mm)											
	0.221	0.470	0.221	0.470	0.185			ARG90	0.021(#2) / 0.021(#4)	CL	TS-D	N
	U-Factor 0.33		SHGC(N) 0.11				VT(N) 0.17		CR 51			
677	Outswing w/ Kickplate: SNX 5123 / Arg / 3mmClr-030PVB-3mmIS20 - 28mm (6mm-6mm)											
	0.221	0.625	0.264					ARG90	0.021(#2) / 0.198(#4)	CL	TS-D	N
	U-Factor 0.38		SHGC(N) 0.14				VT(N) 0.28		CR 51			
678	Outswing w/ Kickplate - NFRC Default: SNX 5123 / Arg / 3mmClr-030PVB-3mmIS20 - 28mm (6mm-6mm)											
	0.221	0.625	0.264					ARG90	0.021(#2) / 0.198(#4)	CL	TS-D	T
	U-Factor 0.50		SHGC(>1) 0.11				VT(>1) 0.20		CR 51			
679	Outswing w/ Kickplate - 1 Horizontal TDL: SNX 5123 / Arg / Clr - 28mm(6mm-6mm)											
	0.221	0.630	0.224					ARG90	0.021(#2)	CL	A1-D	T
	U-Factor 0.44		SHGC(>1) 0.12				VT(>1) 0.21		CR 50			
680	Outswing w/ Kickplate - 1 Horizontal TDL: SNX 6227 / Arg / Clr - 28mm(6mm-6mm)											
	0.221	0.630	0.224					ARG90	0.020(#2)	CL	A1-D	T
	U-Factor 0.44		SHGC(>1) 0.13				VT(>1) 0.26		CR 50			

TEST REPORT FOR NEON ENERGY USA INC.

Report No: K0461.02-301-45 R3

Date: 12/18/20

SECTION 6 (Continued)

SIMULATION RESULTS

TOTAL PRODUCT CALCULATIONS (Ultra Outswing and Inswing Door)												
Option Number	Pane Thickness 1 (in)	Gap Width 1 (in)	Pane Thickness 2 (in)	Gap Width 2 (in)	Pane Thickness 3 (in)	Gap Width 3 (in)	Pane Thickness 4 (in)	Gap Fill	Low-e (Surface #)	Tint	Spacer	Grid Type
	U-Factor (Btu/Hr-Ft2-F)			Solar Heat Gain Coefficient (SHGC) Grids (None / <1 / >=1)				Visible Transmittance (VT) Grids (None / <1 / >=1)		Condensation Resistance (CR)		
681	Outswing w/ Kickplate - 1 Horizontal TDL: ClimaGuard Premium T / Arg / Clr - 27mm(6mm-5mm)											
	0.230	0.630	0.185					ARG90	0.035(#2)	CL	A1-D	T
	U-Factor 0.44			SHGC(>1) 0.23				VT(>1) 0.32		CR 50		
682	Outswing w/ Kickplate - 1 Horizontal TDL: SN 4023 / Arg / Clr - 27mm(6mm-5mm)											
	0.230	0.630	0.185					ARG90	0.026(#2)	CL	A1-D	T
	U-Factor 0.44			SHGC(>1) 0.11				VT(>1) 0.16		CR 50		
683	Outswing w/ Kickplate - 1 Horizontal TDL: SN 5128 / Arg / Clr - 27mm(6mm-5mm)											
	0.230	0.630	0.185					ARG90	0.025(#2)	CL	A1-D	T
	U-Factor 0.44			SHGC(>1) 0.13				VT(>1) 0.21		CR 50		
684	Outswing w/ Kickplate - 1 Horizontal TDL: SN 6234 / Arg / Clr - 27mm(6mm-5mm)											
	0.230	0.630	0.185					ARG90	0.026(#2)	CL	A1-D	T
	U-Factor 0.44			SHGC(>1) 0.15				VT(>1) 0.26		CR 50		
685	Outswing w/ Kickplate - 1 Horizontal TDL: SN 7037 / Arg / Clr - 27mm(6mm-5mm)											
	0.230	0.630	0.185					ARG90	0.022(#2)	CL	A1-D	T
	U-Factor 0.44			SHGC(>1) 0.17				VT(>1) 0.29		CR 50		
686	Outswing w/ Kickplate - 1 Horizontal TDL: ClimaGuard Neutral 70 / Arg / Clr - 27mm(6mm-5mm)											
	0.226	0.630	0.185					ARG90	0.171(#2)	CL	A1-D	T
	U-Factor 0.47			SHGC(>1) 0.25				VT(>1) 0.28		CR 49		
687	Outswing w/ Kickplate - 1 Horizontal TDL: SNX 6227 / Arg / Clr - 24mm(4mm-4mm)											
	0.151	0.630	0.154					ARG90	0.020(#2)	CL	A1-D	T
	U-Factor 0.44			SHGC(>1) 0.13				VT(>1) 0.26		CR 50		
688	Outswing w/ Kickplate - 1 Horizontal TDL: ClimaGuard Premium T / Arg / Clr - 24mm(4mm-4mm)											
	0.151	0.630	0.154					ARG90	0.035(#2)	CL	A1-D	T
	U-Factor 0.44			SHGC(>1) 0.24				VT(>1) 0.32		CR 49		
689	Outswing w/ Kickplate - 1 Horizontal TDL: SN 4023 / Arg / Clr - 24mm(4mm-4mm)											
	0.151	0.630	0.154					ARG90	0.026(#2)	CL	A1-D	T
	U-Factor 0.44			SHGC(>1) 0.11				VT(>1) 0.17		CR 50		
690	Outswing w/ Kickplate - 1 Horizontal TDL: SN 5128 / Arg / Clr - 24mm(4mm-4mm)											
	0.151	0.630	0.154					ARG90	0.025(#2)	CL	A1-D	T
	U-Factor 0.44			SHGC(>1) 0.13				VT(>1) 0.21		CR 50		

TEST REPORT FOR NEON ENERGY USA INC.

Report No: K0461.02-301-45 R3

Date: 12/18/20

SECTION 6 (Continued)

SIMULATION RESULTS

TOTAL PRODUCT CALCULATIONS (Ultra Outswing and Inswing Door)												
Option Number	Pane Thickness 1 (in)	Gap Width 1 (in)	Pane Thickness 2 (in)	Gap Width 2 (in)	Pane Thickness 3 (in)	Gap Width 3 (in)	Pane Thickness 4 (in)	Gap Fill	Low-e (Surface #)	Tint	Spacer	Grid Type
	U-Factor (Btu/Hr-Ft ² -F)			Solar Heat Gain Coefficient (SHGC) Grids (None / <1 / >=1)				Visible Transmittance (VT) Grids (None / <1 / >=1)		Condensation Resistance (CR)		
691	Outswing w/ Kickplate - 1 Horizontal TDL: SN 6234 / Arg / Clr - 24mm(4mm-4mm)											
	0.151	0.630	0.154					ARG90	0.026(#2)	CL	A1-D	T
	U-Factor 0.44			SHGC(>1) 0.15				VT(>1) 0.26		CR 50		
692	Outswing w/ Kickplate - 1 Horizontal TDL: SN 7037 / Arg / Clr - 24mm(4mm-4mm)											
	0.151	0.630	0.154					ARG90	0.022(#2)	CL	A1-D	T
	U-Factor 0.44			SHGC(>1) 0.17				VT(>1) 0.29		CR 50		
693	Outswing w/ Kickplate - 1 Horizontal TDL: ClimaGuard Neutral 70 / Arg / Clr - 24mm(4mm-4mm)											
	0.148	0.630	0.154					ARG90	0.171(#2)	CL	A1-D	T
	U-Factor 0.47			SHGC(>1) 0.25				VT(>1) 0.29		CR 49		
694	Outswing w/ Kickplate - 1 Horizontal TDL: ClimaGuard Neutral 70 / Arg / Clr - 28mm(6mm-5mm)											
	0.226	0.670	0.185					ARG90	0.171(#2)	CL	A1-D	T
	U-Factor 0.47			SHGC(>1) 0.25				VT(>1) 0.28		CR 49		
695	Outswing w/ Kickplate - 1 Horizontal TDL: ClimaGuard Neutral 70 / Arg / Clr - 28mm(4mm-4mm)											
	0.226	0.787	0.185					ARG90	0.171(#2)	CL	A1-D	T
	U-Factor 0.47			SHGC(>1) 0.25				VT(>1) 0.28		CR 48		
696	Outswing w/ Kickplate - 1 Horizontal TDL: SNX 5123 / Arg / 3mmClr-030PVB-3mmIS20 - 28mm (6mm-6mm)											
	0.221	0.625	0.264					ARG90	0.021(#2) / 0.198(#4)	CL	TS-D	T
	U-Factor 0.39			SHGC(>1) 0.11				VT(>1) 0.20		CR 51		
697	Outswing w/ Kickplate - 2 Horizontal TDLs: SNX 5123 / Arg / Clr - 28mm(6mm-6mm)											
	0.221	0.630	0.224					ARG90	0.021(#2)	CL	A1-D	T
	U-Factor 0.45			SHGC(>1) 0.12				VT(>1) 0.21		CR 50		
698	Outswing w/ Kickplate - 2 Horizontal TDLs: SNX 6227 / Arg / Clr - 28mm(6mm-6mm)											
	0.221	0.630	0.224					ARG90	0.020(#2)	CL	A1-D	T
	U-Factor 0.45			SHGC(>1) 0.13				VT(>1) 0.26		CR 50		
699	Outswing w/ Kickplate - 2 Horizontal TDLs: ClimaGuard Premium T / Arg / Clr - 27mm(6mm-5mm)											
	0.230	0.630	0.185					ARG90	0.035(#2)	CL	A1-D	T
	U-Factor 0.46			SHGC(>1) 0.23				VT(>1) 0.32		CR 50		
700	Outswing w/ Kickplate - 2 Horizontal TDLs: SN 4023 / Arg / Clr - 27mm(6mm-5mm)											
	0.230	0.630	0.185					ARG90	0.026(#2)	CL	A1-D	T
	U-Factor 0.45			SHGC(>1) 0.11				VT(>1) 0.16		CR 50		

TEST REPORT FOR NEON ENERGY USA INC.

Report No: K0461.02-301-45 R3

Date: 12/18/20

SECTION 6 (Continued)
SIMULATION RESULTS

TOTAL PRODUCT CALCULATIONS (Ultra Outswing and Inswing Door)												
Option Number	Pane Thickness 1 (in)	Gap Width 1 (in)	Pane Thickness 2 (in)	Gap Width 2 (in)	Pane Thickness 3 (in)	Gap Width 3 (in)	Pane Thickness 4 (in)	Gap Fill	Low-e (Surface #)	Tint	Spacer	Grid Type
	U-Factor (Btu/Hr-Ft2-F)			Solar Heat Gain Coefficient (SHGC) Grids (None / <1 / >=1)				Visible Transmittance (VT) Grids (None / <1 / >=1)		Condensation Resistance (CR)		
701	Outswing w/ Kickplate - 2 Horizontal TDs: SN 5128 / Arg / Clr - 27mm(6mm-5mm)											
	0.230	0.630	0.185					ARG90	0.025(#2)	CL	A1-D	T
	U-Factor 0.45			SHGC(>1) 0.13				VT(>1) 0.21		CR 50		
702	Outswing w/ Kickplate - 2 Horizontal TDs: SN 6234 / Arg / Clr - 27mm(6mm-5mm)											
	0.230	0.630	0.185					ARG90	0.026(#2)	CL	A1-D	T
	U-Factor 0.45			SHGC(>1) 0.15				VT(>1) 0.26		CR 50		
703	Outswing w/ Kickplate - 2 Horizontal TDs: SN 7037 / Arg / Clr - 27mm(6mm-5mm)											
	0.230	0.630	0.185					ARG90	0.022(#2)	CL	A1-D	T
	U-Factor 0.45			SHGC(>1) 0.17				VT(>1) 0.29		CR 50		
704	Outswing w/ Kickplate - 2 Horizontal TDs: ClimaGuard Neutral 70 / Arg / Clr - 27mm(6mm-5mm)											
	0.226	0.630	0.185					ARG90	0.171(#2)	CL	A1-D	T
	U-Factor 0.48			SHGC(>1) 0.25				VT(>1) 0.28		CR 49		
705	Outswing w/ Kickplate - 2 Horizontal TDs: SNX 6227 / Arg / Clr - 24mm(4mm-4mm)											
	0.151	0.630	0.154					ARG90	0.020(#2)	CL	A1-D	T
	U-Factor 0.45			SHGC(>1) 0.13				VT(>1) 0.26		CR 50		
706	Outswing w/ Kickplate - 2 Horizontal TDs: ClimaGuard Premium T / Arg / Clr - 24mm(4mm-4mm)											
	0.151	0.630	0.154					ARG90	0.035(#2)	CL	A1-D	T
	U-Factor 0.46			SHGC(>1) 0.24				VT(>1) 0.32		CR 49		
707	Outswing w/ Kickplate - 2 Horizontal TDs: SN 4023 / Arg / Clr - 24mm(4mm-4mm)											
	0.151	0.630	0.154					ARG90	0.026(#2)	CL	A1-D	T
	U-Factor 0.46			SHGC(>1) 0.11				VT(>1) 0.17		CR 50		
708	Outswing w/ Kickplate - 2 Horizontal TDs: SN 5128 / Arg / Clr - 24mm(4mm-4mm)											
	0.151	0.630	0.154					ARG90	0.025(#2)	CL	A1-D	T
	U-Factor 0.46			SHGC(>1) 0.13				VT(>1) 0.21		CR 50		
709	Outswing w/ Kickplate - 2 Horizontal TDs: SN 6234 / Arg / Clr - 24mm(4mm-4mm)											
	0.151	0.630	0.154					ARG90	0.026(#2)	CL	A1-D	T
	U-Factor 0.46			SHGC(>1) 0.15				VT(>1) 0.26		CR 50		
710	Outswing w/ Kickplate - 2 Horizontal TDs: SN 7037 / Arg / Clr - 24mm(4mm-4mm)											
	0.151	0.630	0.154					ARG90	0.022(#2)	CL	A1-D	T
	U-Factor 0.45			SHGC(>1) 0.17				VT(>1) 0.29		CR 50		

TEST REPORT FOR NEON ENERGY USA INC.

Report No: K0461.02-301-45 R3

Date: 12/18/20

SECTION 6 (Continued)

SIMULATION RESULTS

TOTAL PRODUCT CALCULATIONS (Ultra Outswing and Inswing Door)												
Option Number	Pane Thickness 1 (in)	Gap Width 1 (in)	Pane Thickness 2 (in)	Gap Width 2 (in)	Pane Thickness 3 (in)	Gap Width 3 (in)	Pane Thickness 4 (in)	Gap Fill	Low-e (Surface #)	Tint	Spacer	Grid Type
	U-Factor (Btu/Hr-Ft2-F)			Solar Heat Gain Coefficient (SHGC) Grids (None / <1 / >=1)				Visible Transmittance (VT) Grids (None / <1 / >=1)		Condensation Resistance (CR)		
711	Outswing w/ Kickplate - 2 Horizontal TDs: ClimaGuard Neutral 70 / Arg / Clr - 24mm(4mm-4mm)											
	0.148	0.630	0.154					ARG90	0.171(#2)	CL	A1-D	T
	U-Factor 0.48			SHGC(>1) 0.25				VT(>1) 0.29		CR 49		
712	Outswing w/ Kickplate - 2 Horizontal TDs: ClimaGuard Neutral 70 / Arg / Clr - 28mm(6mm-5mm)											
	0.226	0.670	0.185					ARG90	0.171(#2)	CL	A1-D	T
	U-Factor 0.48			SHGC(>1) 0.25				VT(>1) 0.28		CR 49		
713	Outswing w/ Kickplate - 2 Horizontal TDs: ClimaGuard Neutral 70 / Arg / Clr - 28mm(4mm-4mm)											
	0.226	0.787	0.185					ARG90	0.171(#2)	CL	A1-D	T
	U-Factor 0.49			SHGC(>1) 0.25				VT(>1) 0.28		CR 48		
714	Outswing w/ Kickplate - 2 Horizontal TDs: SNX 5123 / Arg / 3mmClr-030PVB-3mmIS20 - 28mm (6mm-6mm)											
	0.221	0.625	0.264					ARG90	0.021(#2) / 0.198(#4)	CL	TS-D	T
	U-Factor 0.40			SHGC(>1) 0.11				VT(>1) 0.20		CR 51		
715	Outswing w/ Kickplate - 3 Horizontal TDs: SNX 5123 / Arg / Clr - 28mm(6mm-6mm)											
	0.221	0.630	0.224					ARG90	0.021(#2)	CL	A1-D	T
	U-Factor 0.47			SHGC(>1) 0.12				VT(>1) 0.21		CR 50		
716	Outswing w/ Kickplate - 3 Horizontal TDs: SNX 6227 / Arg / Clr - 28mm(6mm-6mm)											
	0.221	0.630	0.224					ARG90	0.020(#2)	CL	A1-D	T
	U-Factor 0.47			SHGC(>1) 0.13				VT(>1) 0.26		CR 50		
717	Outswing w/ Kickplate - 3 Horizontal TDs: ClimaGuard Premium T / Arg / Clr - 27mm(6mm-5mm)											
	0.230	0.630	0.185					ARG90	0.035(#2)	CL	A1-D	T
	U-Factor 0.47			SHGC(>1) 0.23				VT(>1) 0.32		CR 50		
718	Outswing w/ Kickplate - 3 Horizontal TDs: SN 4023 / Arg / Clr - 27mm(6mm-5mm)											
	0.230	0.630	0.185					ARG90	0.026(#2)	CL	A1-D	T
	U-Factor 0.47			SHGC(>1) 0.11				VT(>1) 0.16		CR 50		
719	Outswing w/ Kickplate - 3 Horizontal TDs: SN 5128 / Arg / Clr - 27mm(6mm-5mm)											
	0.230	0.630	0.185					ARG90	0.025(#2)	CL	A1-D	T
	U-Factor 0.47			SHGC(>1) 0.13				VT(>1) 0.21		CR 50		
720	Outswing w/ Kickplate - 3 Horizontal TDs: SN 6234 / Arg / Clr - 27mm(6mm-5mm)											
	0.230	0.630	0.185					ARG90	0.026(#2)	CL	A1-D	T
	U-Factor 0.47			SHGC(>1) 0.15				VT(>1) 0.26		CR 50		

TEST REPORT FOR NEON ENERGY USA INC.

Report No: K0461.02-301-45 R3

Date: 12/18/20

SECTION 6 (Continued)

SIMULATION RESULTS

TOTAL PRODUCT CALCULATIONS (Ultra Outswing and Inswing Door)												
Option Number	Pane Thickness 1 (in)	Gap Width 1 (in)	Pane Thickness 2 (in)	Gap Width 2 (in)	Pane Thickness 3 (in)	Gap Width 3 (in)	Pane Thickness 4 (in)	Gap Fill	Low-e (Surface #)	Tint	Spacer	Grid Type
	U-Factor (Btu/Hr-Ft ² -F)			Solar Heat Gain Coefficient (SHGC) Grids (None / <1 / >=1)				Visible Transmittance (VT) Grids (None / <1 / >=1)		Condensation Resistance (CR)		
721	Outswing w/ Kickplate - 3 Horizontal TDs: SN 7037 / Arg / Clr - 27mm(6mm-5mm)											
	0.230	0.630	0.185					ARG90	0.022(#2)	CL	A1-D	T
	U-Factor 0.47			SHGC(>1) 0.17				VT(>1) 0.29		CR 50		
722	Outswing w/ Kickplate - 3 Horizontal TDs: ClimaGuard Neutral 70 / Arg / Clr - 27mm(6mm-5mm)											
	0.226	0.630	0.185					ARG90	0.171(#2)	CL	A1-D	T
	U-Factor 0.49			SHGC(>1) 0.25				VT(>1) 0.28		CR 49		
723	Outswing w/ Kickplate - 3 Horizontal TDs: SNX 6227 / Arg / Clr - 24mm(4mm-4mm)											
	0.151	0.630	0.154					ARG90	0.020(#2)	CL	A1-D	T
	U-Factor 0.47			SHGC(>1) 0.13				VT(>1) 0.26		CR 50		
724	Outswing w/ Kickplate - 3 Horizontal TDs: ClimaGuard Premium T / Arg / Clr - 24mm(4mm-4mm)											
	0.151	0.630	0.154					ARG90	0.035(#2)	CL	A1-D	T
	U-Factor 0.47			SHGC(>1) 0.24				VT(>1) 0.32		CR 49		
725	Outswing w/ Kickplate - 3 Horizontal TDs: SN 4023 / Arg / Clr - 24mm(4mm-4mm)											
	0.151	0.630	0.154					ARG90	0.026(#2)	CL	A1-D	T
	U-Factor 0.47			SHGC(>1) 0.11				VT(>1) 0.17		CR 50		
726	Outswing w/ Kickplate - 3 Horizontal TDs: SN 5128 / Arg / Clr - 24mm(4mm-4mm)											
	0.151	0.630	0.154					ARG90	0.025(#2)	CL	A1-D	T
	U-Factor 0.47			SHGC(>1) 0.13				VT(>1) 0.21		CR 50		
727	Outswing w/ Kickplate - 3 Horizontal TDs: SN 6234 / Arg / Clr - 24mm(4mm-4mm)											
	0.151	0.630	0.154					ARG90	0.026(#2)	CL	A1-D	T
	U-Factor 0.47			SHGC(>1) 0.15				VT(>1) 0.26		CR 50		
728	Outswing w/ Kickplate - 3 Horizontal TDs: SN 7037 / Arg / Clr - 24mm(4mm-4mm)											
	0.151	0.630	0.154					ARG90	0.022(#2)	CL	A1-D	T
	U-Factor 0.47			SHGC(>1) 0.17				VT(>1) 0.29		CR 50		
729	Outswing w/ Kickplate - 3 Horizontal TDs: ClimaGuard Neutral 70 / Arg / Clr - 24mm(4mm-4mm)											
	0.148	0.630	0.154					ARG90	0.171(#2)	CL	A1-D	T
	U-Factor 0.49			SHGC(>1) 0.25				VT(>1) 0.29		CR 49		
730	Outswing w/ Kickplate - 3 Horizontal TDs: ClimaGuard Neutral 70 / Arg / Clr - 28mm(6mm-5mm)											
	0.226	0.670	0.185					ARG90	0.171(#2)	CL	A1-D	T
	U-Factor 0.50			SHGC(>1) 0.25				VT(>1) 0.28		CR 49		

TEST REPORT FOR NEON ENERGY USA INC.

Report No: K0461.02-301-45 R3

Date: 12/18/20

SECTION 6 (Continued) SIMULATION RESULTS

TOTAL PRODUCT CALCULATIONS (Ultra Outswing and Inswing Door)												
Option Number	Pane Thickness 1 (in)	Gap Width 1 (in)	Pane Thickness 2 (in)	Gap Width 2 (in)	Pane Thickness 3 (in)	Gap Width 3 (in)	Pane Thickness 4 (in)	Gap Fill	Low-e (Surface #)	Tint	Spacer	Grid Type
	U-Factor (Btu/Hr-Ft2-F)		Solar Heat Gain Coefficient (SHGC) Grids (None / <1 / >=1)				Visible Transmittance (VT) Grids (None / <1 / >=1)		Condensation Resistance (CR)			
731	Outswing w/ Kickplate - 3 Horizontal TDs: ClimaGuard Neutral 70 / Arg / Clr - 28mm(4mm-4mm)											
	0.226	0.787	0.185					ARG90	0.171(#2)	CL	A1-D	T
	U-Factor 0.50		SHGC(>1) 0.25				VT(>1) 0.28		CR 48			
732	Outswing w/ Kickplate - 3 Horizontal TDs: SNX 5123 / Arg / 3mmClr-030PVB-3mmIS20 - 28mm (6mm-6mm)											
	0.221	0.625	0.264					ARG90	0.021(#2) / 0.198(#4)	CL	TS-D	T
	U-Factor 0.41		SHGC(>1) 0.11				VT(>1) 0.20		CR 51			
733	Outswing w/ Kickplate - 4 Horizontal TDs: SNX 5123 / Arg / Clr - 28mm(6mm-6mm)											
	0.221	0.630	0.224					ARG90	0.021(#2)	CL	A1-D	T
	U-Factor 0.48		SHGC(>1) 0.12				VT(>1) 0.21		CR 50			
734	Outswing w/ Kickplate - 4 Horizontal TDs: SNX 6227 / Arg / Clr - 28mm(6mm-6mm)											
	0.221	0.630	0.224					ARG90	0.020(#2)	CL	A1-D	T
	U-Factor 0.48		SHGC(>1) 0.13				VT(>1) 0.26		CR 50			
735	Outswing w/ Kickplate - 4 Horizontal TDs: ClimaGuard Premium T / Arg / Clr - 27mm(6mm-5mm)											
	0.230	0.630	0.185					ARG90	0.035(#2)	CL	A1-D	T
	U-Factor 0.48		SHGC(>1) 0.23				VT(>1) 0.32		CR 50			
736	Outswing w/ Kickplate - 4 Horizontal TDs: SN 4023 / Arg / Clr - 27mm(6mm-5mm)											
	0.230	0.630	0.185					ARG90	0.026(#2)	CL	A1-D	T
	U-Factor 0.48		SHGC(>1) 0.11				VT(>1) 0.16		CR 50			
737	Outswing w/ Kickplate - 4 Horizontal TDs: SN 5128 / Arg / Clr - 27mm(6mm-5mm)											
	0.230	0.630	0.185					ARG90	0.025(#2)	CL	A1-D	T
	U-Factor 0.48		SHGC(>1) 0.13				VT(>1) 0.21		CR 50			
738	Outswing w/ Kickplate - 4 Horizontal TDs: SN 6234 / Arg / Clr - 27mm(6mm-5mm)											
	0.230	0.630	0.185					ARG90	0.026(#2)	CL	A1-D	T
	U-Factor 0.48		SHGC(>1) 0.15				VT(>1) 0.26		CR 50			
739	Outswing w/ Kickplate - 4 Horizontal TDs: SN 7037 / Arg / Clr - 27mm(6mm-5mm)											
	0.230	0.630	0.185					ARG90	0.022(#2)	CL	A1-D	T
	U-Factor 0.48		SHGC(>1) 0.17				VT(>1) 0.29		CR 50			
740	Outswing w/ Kickplate - 4 Horizontal TDs: ClimaGuard Neutral 70 / Arg / Clr - 27mm(6mm-5mm)											
	0.226	0.630	0.185					ARG90	0.171(#2)	CL	A1-D	T
	U-Factor 0.51		SHGC(>1) 0.25				VT(>1) 0.28		CR 49			

TEST REPORT FOR NEON ENERGY USA INC.

Report No: K0461.02-301-45 R3

Date: 12/18/20

SECTION 6 (Continued)

SIMULATION RESULTS

TOTAL PRODUCT CALCULATIONS (Ultra Outswing and Inswing Door)												
Option Number	Pane Thickness 1 (in)	Gap Width 1 (in)	Pane Thickness 2 (in)	Gap Width 2 (in)	Pane Thickness 3 (in)	Gap Width 3 (in)	Pane Thickness 4 (in)	Gap Fill	Low-e (Surface #)	Tint	Spacer	Grid Type
	U-Factor (Btu/Hr-Ft ² -F)			Solar Heat Gain Coefficient (SHGC) Grids (None / <1 / >=1)				Visible Transmittance (VT) Grids (None / <1 / >=1)		Condensation Resistance (CR)		
741	Outswing w/ Kickplate - 4 Horizontal TDs: SNX 6227 / Arg / Clr - 24mm(4mm-4mm)											
	0.151	0.630	0.154					ARG90	0.020(#2)	CL	A1-D	T
	U-Factor 0.48			SHGC(>1) 0.13				VT(>1) 0.26		CR 50		
742	Outswing w/ Kickplate - 4 Horizontal TDs: ClimaGuard Premium T / Arg / Clr - 24mm(4mm-4mm)											
	0.151	0.630	0.154					ARG90	0.035(#2)	CL	A1-D	T
	U-Factor 0.48			SHGC(>1) 0.24				VT(>1) 0.32		CR 49		
743	Outswing w/ Kickplate - 4 Horizontal TDs: SN 4023 / Arg / Clr - 24mm(4mm-4mm)											
	0.151	0.630	0.154					ARG90	0.026(#2)	CL	A1-D	T
	U-Factor 0.48			SHGC(>1) 0.11				VT(>1) 0.17		CR 50		
744	Outswing w/ Kickplate - 4 Horizontal TDs: SN 5128 / Arg / Clr - 24mm(4mm-4mm)											
	0.151	0.630	0.154					ARG90	0.025(#2)	CL	A1-D	T
	U-Factor 0.48			SHGC(>1) 0.13				VT(>1) 0.21		CR 50		
745	Outswing w/ Kickplate - 4 Horizontal TDs: SN 6234 / Arg / Clr - 24mm(4mm-4mm)											
	0.151	0.630	0.154					ARG90	0.026(#2)	CL	A1-D	T
	U-Factor 0.48			SHGC(>1) 0.15				VT(>1) 0.26		CR 50		
746	Outswing w/ Kickplate - 4 Horizontal TDs: SN 7037 / Arg / Clr - 24mm(4mm-4mm)											
	0.151	0.630	0.154					ARG90	0.022(#2)	CL	A1-D	T
	U-Factor 0.48			SHGC(>1) 0.17				VT(>1) 0.29		CR 50		
747	Outswing w/ Kickplate - 4 Horizontal TDs: ClimaGuard Neutral 70 / Arg / Clr - 24mm(4mm-4mm)											
	0.148	0.630	0.154					ARG90	0.171(#2)	CL	A1-D	T
	U-Factor 0.51			SHGC(>1) 0.25				VT(>1) 0.29		CR 49		
748	Outswing w/ Kickplate - 4 Horizontal TDs: ClimaGuard Neutral 70 / Arg / Clr - 28mm(6mm-5mm)											
	0.226	0.670	0.185					ARG90	0.171(#2)	CL	A1-D	T
	U-Factor 0.51			SHGC(>1) 0.25				VT(>1) 0.28		CR 49		
749	Outswing w/ Kickplate - 4 Horizontal TDs: ClimaGuard Neutral 70 / Arg / Clr - 28mm(4mm-4mm)											
	0.226	0.787	0.185					ARG90	0.171(#2)	CL	A1-D	T
	U-Factor 0.52			SHGC(>1) 0.25				VT(>1) 0.28		CR 48		
750	Outswing w/ Kickplate - 4 Horizontal TDs: SNX 5123 / Arg / 3mmClr-030PVB-3mmIS20 - 28mm (6mm-6mm)											
	0.221	0.625	0.264					ARG90	0.021(#2) / 0.198(#4)	CL	TS-D	T
	U-Factor 0.42			SHGC(>1) 0.11				VT(>1) 0.20		CR 51		

TEST REPORT FOR NEON ENERGY USA INC.

Report No: K0461.02-301-45 R3

Date: 12/18/20

SECTION 6 (Continued)

SIMULATION RESULTS

TOTAL PRODUCT CALCULATIONS (Ultra Outswing and Inswing Door)												
Option Number	Pane Thickness 1 (in)	Gap Width 1 (in)	Pane Thickness 2 (in)	Gap Width 2 (in)	Pane Thickness 3 (in)	Gap Width 3 (in)	Pane Thickness 4 (in)	Gap Fill	Low-e (Surface #)	Tint	Spacer	Grid Type
	U-Factor (Btu/Hr-Ft2-F)			Solar Heat Gain Coefficient (SHGC) Grids (None / <1 / >=1)				Visible Transmittance (VT) Grids (None / <1 / >=1)		Condensation Resistance (CR)		
751	Outswing w/ Kickplate - 1 Vertical TDL: SNX 5123 / Arg / Clr - 28mm(6mm-6mm)											
	0.221	0.630	0.224					ARG90	0.021(#2)	CL	A1-D	T
	U-Factor 0.46			SHGC(>1) 0.12				VT(>1) 0.21		CR 50		
752	Outswing w/ Kickplate - 1 Vertical TDL: SNX 6227 / Arg / Clr - 28mm(6mm-6mm)											
	0.221	0.630	0.224					ARG90	0.020(#2)	CL	A1-D	T
	U-Factor 0.46			SHGC(>1) 0.13				VT(>1) 0.26		CR 50		
753	Outswing w/ Kickplate - 1 Vertical TDL: ClimaGuard Premium T / Arg / Clr - 27mm(6mm-5mm)											
	0.230	0.630	0.185					ARG90	0.035(#2)	CL	A1-D	T
	U-Factor 0.46			SHGC(>1) 0.23				VT(>1) 0.32		CR 50		
754	Outswing w/ Kickplate - 1 Vertical TDL: SN 4023 / Arg / Clr - 27mm(6mm-5mm)											
	0.230	0.630	0.185					ARG90	0.026(#2)	CL	A1-D	T
	U-Factor 0.46			SHGC(>1) 0.11				VT(>1) 0.16		CR 50		
755	Outswing w/ Kickplate - 1 Vertical TDL: SN 5128 / Arg / Clr - 27mm(6mm-5mm)											
	0.230	0.630	0.185					ARG90	0.025(#2)	CL	A1-D	T
	U-Factor 0.46			SHGC(>1) 0.13				VT(>1) 0.21		CR 50		
756	Outswing w/ Kickplate - 1 Vertical TDL: SN 6234 / Arg / Clr - 27mm(6mm-5mm)											
	0.230	0.630	0.185					ARG90	0.026(#2)	CL	A1-D	T
	U-Factor 0.46			SHGC(>1) 0.15				VT(>1) 0.26		CR 50		
757	Outswing w/ Kickplate - 1 Vertical TDL: SN 7037 / Arg / Clr - 27mm(6mm-5mm)											
	0.230	0.630	0.185					ARG90	0.022(#2)	CL	A1-D	T
	U-Factor 0.46			SHGC(>1) 0.17				VT(>1) 0.29		CR 50		
758	Outswing w/ Kickplate - 1 Vertical TDL: ClimaGuard Neutral 70 / Arg / Clr - 27mm(6mm-5mm)											
	0.226	0.630	0.185					ARG90	0.171(#2)	CL	A1-D	T
	U-Factor 0.49			SHGC(>1) 0.25				VT(>1) 0.28		CR 49		
759	Outswing w/ Kickplate - 1 Vertical TDL: SNX 6227 / Arg / Clr - 24mm(4mm-4mm)											
	0.151	0.630	0.154					ARG90	0.020(#2)	CL	A1-D	T
	U-Factor 0.46			SHGC(>1) 0.13				VT(>1) 0.26		CR 50		
760	Outswing w/ Kickplate - 1 Vertical TDL: ClimaGuard Premium T / Arg / Clr - 24mm(4mm-4mm)											
	0.151	0.630	0.154					ARG90	0.035(#2)	CL	A1-D	T
	U-Factor 0.46			SHGC(>1) 0.24				VT(>1) 0.32		CR 49		

TEST REPORT FOR NEON ENERGY USA INC.

Report No: K0461.02-301-45 R3

Date: 12/18/20

SECTION 6 (Continued) SIMULATION RESULTS

TOTAL PRODUCT CALCULATIONS (Ultra Outswing and Inswing Door)												
Option Number	Pane Thickness 1 (in)	Gap Width 1 (in)	Pane Thickness 2 (in)	Gap Width 2 (in)	Pane Thickness 3 (in)	Gap Width 3 (in)	Pane Thickness 4 (in)	Gap Fill	Low-e (Surface #)	Tint	Spacer	Grid Type
	U-Factor (Btu/Hr-Ft2-F)			Solar Heat Gain Coefficient (SHGC) Grids (None / <1 / >=1)				Visible Transmittance (VT) Grids (None / <1 / >=1)		Condensation Resistance (CR)		
761	Outswing w/ Kickplate - 1 Vertical TDL: SN 4023 / Arg / Clr - 24mm(4mm-4mm)											
	0.151	0.630	0.154					ARG90	0.026(#2)	CL	A1-D	T
	U-Factor 0.46			SHGC(>1) 0.11				VT(>1) 0.17		CR 50		
762	Outswing w/ Kickplate - 1 Vertical TDL: SN 5128 / Arg / Clr - 24mm(4mm-4mm)											
	0.151	0.630	0.154					ARG90	0.025(#2)	CL	A1-D	T
	U-Factor 0.46			SHGC(>1) 0.13				VT(>1) 0.21		CR 50		
763	Outswing w/ Kickplate - 1 Vertical TDL: SN 6234 / Arg / Clr - 24mm(4mm-4mm)											
	0.151	0.630	0.154					ARG90	0.026(#2)	CL	A1-D	T
	U-Factor 0.46			SHGC(>1) 0.15				VT(>1) 0.26		CR 50		
764	Outswing w/ Kickplate - 1 Vertical TDL: SN 7037 / Arg / Clr - 24mm(4mm-4mm)											
	0.151	0.630	0.154					ARG90	0.022(#2)	CL	A1-D	T
	U-Factor 0.46			SHGC(>1) 0.17				VT(>1) 0.29		CR 50		
765	Outswing w/ Kickplate - 1 Vertical TDL: ClimaGuard Neutral 70 / Arg / Clr - 24mm(4mm-4mm)											
	0.148	0.630	0.154					ARG90	0.171(#2)	CL	A1-D	T
	U-Factor 0.49			SHGC(>1) 0.25				VT(>1) 0.29		CR 49		
766	Outswing w/ Kickplate - 1 Vertical TDL: ClimaGuard Neutral 70 / Arg / Clr - 28mm(6mm-5mm)											
	0.226	0.670	0.185					ARG90	0.171(#2)	CL	A1-D	T
	U-Factor 0.49			SHGC(>1) 0.25				VT(>1) 0.28		CR 49		
767	Outswing w/ Kickplate - 1 Vertical TDL: ClimaGuard Neutral 70 / Arg / Clr - 28mm(4mm-4mm)											
	0.226	0.787	0.185					ARG90	0.171(#2)	CL	A1-D	T
	U-Factor 0.49			SHGC(>1) 0.25				VT(>1) 0.28		CR 48		
768	Outswing w/ Kickplate - 1 Vertical TDL: SNX 5123 / Arg / 3mmClr-030PVB-3mmIS20 - 28mm (6mm-6mm)											
	0.221	0.625	0.264					ARG90	0.021(#2) / 0.198(#4)	CL	TS-D	T
	U-Factor 0.40			SHGC(>1) 0.11				VT(>1) 0.20		CR 51		
769	Outswing w/ Kickplate - 2 Vertical TDLS: SNX 5123 / Arg / Clr - 28mm(6mm-6mm)											
	0.221	0.630	0.224					ARG90	0.021(#2)	CL	A1-D	T
	U-Factor 0.50			SHGC(>1) 0.12				VT(>1) 0.21		CR 50		
770	Outswing w/ Kickplate - 2 Vertical TDLS: SNX 6227 / Arg / Clr - 28mm(6mm-6mm)											
	0.221	0.630	0.224					ARG90	0.020(#2)	CL	A1-D	T
	U-Factor 0.50			SHGC(>1) 0.13				VT(>1) 0.26		CR 50		

TEST REPORT FOR NEON ENERGY USA INC.

Report No: K0461.02-301-45 R3

Date: 12/18/20

SECTION 6 (Continued)

SIMULATION RESULTS

TOTAL PRODUCT CALCULATIONS (Ultra Outswing and Inswing Door)												
Option Number	Pane Thickness 1 (in)	Gap Width 1 (in)	Pane Thickness 2 (in)	Gap Width 2 (in)	Pane Thickness 3 (in)	Gap Width 3 (in)	Pane Thickness 4 (in)	Gap Fill	Low-e (Surface #)	Tint	Spacer	Grid Type
	U-Factor (Btu/Hr-Ft ² -F)			Solar Heat Gain Coefficient (SHGC) Grids (None / <1 / >=1)				Visible Transmittance (VT) Grids (None / <1 / >=1)		Condensation Resistance (CR)		
771	Outswing w/ Kickplate - 2 Vertical TDs: ClimaGuard Premium T / Arg / Clr - 27mm(6mm-5mm)											
	0.230	0.630	0.185					ARG90	0.035(#2)	CL	A1-D	T
	U-Factor 0.50			SHGC(>1) 0.23				VT(>1) 0.32		CR 50		
772	Outswing w/ Kickplate - 2 Vertical TDs: SN 4023 / Arg / Clr - 27mm(6mm-5mm)											
	0.230	0.630	0.185					ARG90	0.026(#2)	CL	A1-D	T
	U-Factor 0.50			SHGC(>1) 0.11				VT(>1) 0.16		CR 50		
773	Outswing w/ Kickplate - 2 Vertical TDs: SN 5128 / Arg / Clr - 27mm(6mm-5mm)											
	0.230	0.630	0.185					ARG90	0.025(#2)	CL	A1-D	T
	U-Factor 0.50			SHGC(>1) 0.13				VT(>1) 0.21		CR 50		
774	Outswing w/ Kickplate - 2 Vertical TDs: SN 6234 / Arg / Clr - 27mm(6mm-5mm)											
	0.230	0.630	0.185					ARG90	0.026(#2)	CL	A1-D	T
	U-Factor 0.50			SHGC(>1) 0.15				VT(>1) 0.26		CR 50		
775	Outswing w/ Kickplate - 2 Vertical TDs: SN 7037 / Arg / Clr - 27mm(6mm-5mm)											
	0.230	0.630	0.185					ARG90	0.022(#2)	CL	A1-D	T
	U-Factor 0.50			SHGC(>1) 0.17				VT(>1) 0.29		CR 50		
776	Outswing w/ Kickplate - 2 Vertical TDs: ClimaGuard Neutral 70 / Arg / Clr - 27mm(6mm-5mm)											
	0.226	0.630	0.185					ARG90	0.171(#2)	CL	A1-D	T
	U-Factor 0.52			SHGC(>1) 0.25				VT(>1) 0.28		CR 49		
777	Outswing w/ Kickplate - 2 Vertical TDs: SNX 6227 / Arg / Clr - 24mm(4mm-4mm)											
	0.151	0.630	0.154					ARG90	0.020(#2)	CL	A1-D	T
	U-Factor 0.49			SHGC(>1) 0.13				VT(>1) 0.26		CR 50		
778	Outswing w/ Kickplate - 2 Vertical TDs: ClimaGuard Premium T / Arg / Clr - 24mm(4mm-4mm)											
	0.151	0.630	0.154					ARG90	0.035(#2)	CL	A1-D	T
	U-Factor 0.50			SHGC(>1) 0.24				VT(>1) 0.32		CR 49		
779	Outswing w/ Kickplate - 2 Vertical TDs: SN 4023 / Arg / Clr - 24mm(4mm-4mm)											
	0.151	0.630	0.154					ARG90	0.026(#2)	CL	A1-D	T
	U-Factor 0.50			SHGC(>1) 0.11				VT(>1) 0.17		CR 50		
780	Outswing w/ Kickplate - 2 Vertical TDs: SN 5128 / Arg / Clr - 24mm(4mm-4mm)											
	0.151	0.630	0.154					ARG90	0.025(#2)	CL	A1-D	T
	U-Factor 0.50			SHGC(>1) 0.13				VT(>1) 0.21		CR 50		

TEST REPORT FOR NEON ENERGY USA INC.

Report No: K0461.02-301-45 R3

Date: 12/18/20

SECTION 6 (Continued)
SIMULATION RESULTS

TOTAL PRODUCT CALCULATIONS (Ultra Outswing and Inswing Door)												
Option Number	Pane Thickness 1 (in)	Gap Width 1 (in)	Pane Thickness 2 (in)	Gap Width 2 (in)	Pane Thickness 3 (in)	Gap Width 3 (in)	Pane Thickness 4 (in)	Gap Fill	Low-e (Surface #)	Tint	Spacer	Grid Type
	U-Factor (Btu/Hr-Ft2-F)			Solar Heat Gain Coefficient (SHGC) Grids (None / <1 / >=1)				Visible Transmittance (VT) Grids (None / <1 / >=1)		Condensation Resistance (CR)		
781	Outswing w/ Kickplate - 2 Vertical TDs: SN 6234 / Arg / Clr - 24mm(4mm-4mm)											
	0.151	0.630	0.154					ARG90	0.026(#2)	CL	A1-D	T
	U-Factor 0.50			SHGC(>1) 0.15				VT(>1) 0.26		CR 50		
782	Outswing w/ Kickplate - 2 Vertical TDs: SN 7037 / Arg / Clr - 24mm(4mm-4mm)											
	0.151	0.630	0.154					ARG90	0.022(#2)	CL	A1-D	T
	U-Factor 0.49			SHGC(>1) 0.17				VT(>1) 0.29		CR 50		
783	Outswing w/ Kickplate - 2 Vertical TDs: ClimaGuard Neutral 70 / Arg / Clr - 24mm(4mm-4mm)											
	0.148	0.630	0.154					ARG90	0.171(#2)	CL	A1-D	T
	U-Factor 0.52			SHGC(>1) 0.25				VT(>1) 0.29		CR 49		
784	Outswing w/ Kickplate - 2 Vertical TDs: ClimaGuard Neutral 70 / Arg / Clr - 28mm(6mm-5mm)											
	0.226	0.670	0.185					ARG90	0.171(#2)	CL	A1-D	T
	U-Factor 0.52			SHGC(>1) 0.25				VT(>1) 0.28		CR 49		
785	Outswing w/ Kickplate - 2 Vertical TDs: ClimaGuard Neutral 70 / Arg / Clr - 28mm(4mm-4mm)											
	0.226	0.787	0.185					ARG90	0.171(#2)	CL	A1-D	T
	U-Factor 0.53			SHGC(>1) 0.25				VT(>1) 0.28		CR 48		
786	Outswing w/ Kickplate - 2 Vertical TDs: SNX 5123 / Arg / 3mmClr-030PVB-3mmIS20 - 28mm (6mm-6mm)											
	0.221	0.625	0.264					ARG90	0.021(#2) / 0.198(#4)	CL	TS-D	T
	U-Factor 0.43			SHGC(>1) 0.11				VT(>1) 0.20		CR 51		
787	Outswing w/ Kickplate - 3 Vertical TDs: SNX 5123 / Arg / Clr - 28mm(6mm-6mm)											
	0.221	0.630	0.224					ARG90	0.021(#2)	CL	A1-D	T
	U-Factor 0.53			SHGC(>1) 0.12				VT(>1) 0.21		CR 49		
788	Outswing w/ Kickplate - 3 Vertical TDs: SNX 6227 / Arg / Clr - 28mm(6mm-6mm)											
	0.221	0.630	0.224					ARG90	0.020(#2)	CL	A1-D	T
	U-Factor 0.53			SHGC(>1) 0.13				VT(>1) 0.26		CR 49		
789	Outswing w/ Kickplate - 3 Vertical TDs: ClimaGuard Premium T / Arg / Clr - 27mm(6mm-5mm)											
	0.230	0.630	0.185					ARG90	0.035(#2)	CL	A1-D	T
	U-Factor 0.53			SHGC(>1) 0.23				VT(>1) 0.32		CR 49		
790	Outswing w/ Kickplate - 3 Vertical TDs: SN 4023 / Arg / Clr - 27mm(6mm-5mm)											
	0.230	0.630	0.185					ARG90	0.026(#2)	CL	A1-D	T
	U-Factor 0.53			SHGC(>1) 0.11				VT(>1) 0.16		CR 49		

TEST REPORT FOR NEON ENERGY USA INC.

Report No: K0461.02-301-45 R3

Date: 12/18/20

SECTION 6 (Continued)
SIMULATION RESULTS

TOTAL PRODUCT CALCULATIONS (Ultra Outswing and Inswing Door)												
Option Number	Pane Thickness 1 (in)	Gap Width 1 (in)	Pane Thickness 2 (in)	Gap Width 2 (in)	Pane Thickness 3 (in)	Gap Width 3 (in)	Pane Thickness 4 (in)	Gap Fill	Low-e (Surface #)	Tint	Spacer	Grid Type
	U-Factor (Btu/Hr-Ft2-F)			Solar Heat Gain Coefficient (SHGC) Grids (None / <1 / >=1)				Visible Transmittance (VT) Grids (None / <1 / >=1)		Condensation Resistance (CR)		
791	Outswing w/ Kickplate - 3 Vertical TDLS: SN 5128 / Arg / Clr - 27mm(6mm-5mm)											
	0.230	0.630	0.185					ARG90	0.025(#2)	CL	A1-D	T
	U-Factor 0.53			SHGC(>1) 0.13				VT(>1) 0.21		CR 49		
792	Outswing w/ Kickplate - 3 Vertical TDLS: SN 6234 / Arg / Clr - 27mm(6mm-5mm)											
	0.230	0.630	0.185					ARG90	0.026(#2)	CL	A1-D	T
	U-Factor 0.53			SHGC(>1) 0.15				VT(>1) 0.26		CR 49		
793	Outswing w/ Kickplate - 3 Vertical TDLS: SN 7037 / Arg / Clr - 27mm(6mm-5mm)											
	0.230	0.630	0.185					ARG90	0.022(#2)	CL	A1-D	T
	U-Factor 0.53			SHGC(>1) 0.17				VT(>1) 0.29		CR 49		
794	Outswing w/ Kickplate - 3 Vertical TDLS: ClimaGuard Neutral 70 / Arg / Clr - 27mm(6mm-5mm)											
	0.226	0.630	0.185					ARG90	0.171(#2)	CL	A1-D	T
	U-Factor 0.55			SHGC(>1) 0.25				VT(>1) 0.28		CR 47		
795	Outswing w/ Kickplate - 3 Vertical TDLS: SNX 6227 / Arg / Clr - 24mm(4mm-4mm)											
	0.151	0.630	0.154					ARG90	0.020(#2)	CL	A1-D	T
	U-Factor 0.53			SHGC(>1) 0.13				VT(>1) 0.26		CR 50		
796	Outswing w/ Kickplate - 3 Vertical TDLS: ClimaGuard Premium T / Arg / Clr - 24mm(4mm-4mm)											
	0.151	0.630	0.154					ARG90	0.035(#2)	CL	A1-D	T
	U-Factor 0.53			SHGC(>1) 0.24				VT(>1) 0.32		CR 49		
797	Outswing w/ Kickplate - 3 Vertical TDLS: SN 4023 / Arg / Clr - 24mm(4mm-4mm)											
	0.151	0.630	0.154					ARG90	0.026(#2)	CL	A1-D	T
	U-Factor 0.53			SHGC(>1) 0.11				VT(>1) 0.17		CR 50		
798	Outswing w/ Kickplate - 3 Vertical TDLS: SN 5128 / Arg / Clr - 24mm(4mm-4mm)											
	0.151	0.630	0.154					ARG90	0.025(#2)	CL	A1-D	T
	U-Factor 0.53			SHGC(>1) 0.13				VT(>1) 0.21		CR 50		
799	Outswing w/ Kickplate - 3 Vertical TDLS: SN 6234 / Arg / Clr - 24mm(4mm-4mm)											
	0.151	0.630	0.154					ARG90	0.026(#2)	CL	A1-D	T
	U-Factor 0.53			SHGC(>1) 0.15				VT(>1) 0.26		CR 50		
800	Outswing w/ Kickplate - 3 Vertical TDLS: SN 7037 / Arg / Clr - 24mm(4mm-4mm)											
	0.151	0.630	0.154					ARG90	0.022(#2)	CL	A1-D	T
	U-Factor 0.53			SHGC(>1) 0.17				VT(>1) 0.29		CR 50		

TEST REPORT FOR NEON ENERGY USA INC.

Report No: K0461.02-301-45 R3

Date: 12/18/20

SECTION 6 (Continued)

SIMULATION RESULTS

TOTAL PRODUCT CALCULATIONS (Ultra Outswing and Inswing Door)												
Option Number	Pane Thickness 1 (in)	Gap Width 1 (in)	Pane Thickness 2 (in)	Gap Width 2 (in)	Pane Thickness 3 (in)	Gap Width 3 (in)	Pane Thickness 4 (in)	Gap Fill	Low-e (Surface #)	Tint	Spacer	Grid Type
	U-Factor (Btu/Hr-Ft2-F)			Solar Heat Gain Coefficient (SHGC) Grids (None / <1 / >=1)				Visible Transmittance (VT) Grids (None / <1 / >=1)		Condensation Resistance (CR)		
801	Outswing w/ Kickplate - 3 Vertical TDs: ClimaGuard Neutral 70 / Arg / Clr - 24mm(4mm-4mm)											
	0.148	0.630	0.154					ARG90	0.171(#2)	CL	A1-D	T
	U-Factor 0.55			SHGC(>1) 0.25				VT(>1) 0.29		CR 49		
802	Outswing w/ Kickplate - 3 Vertical TDs: ClimaGuard Neutral 70 / Arg / Clr - 28mm(6mm-5mm)											
	0.226	0.670	0.185					ARG90	0.171(#2)	CL	A1-D	T
	U-Factor 0.55			SHGC(>1) 0.25				VT(>1) 0.28		CR 47		
803	Outswing w/ Kickplate - 3 Vertical TDs: ClimaGuard Neutral 70 / Arg / Clr - 28mm(4mm-4mm)											
	0.226	0.787	0.185					ARG90	0.171(#2)	CL	A1-D	T
	U-Factor 0.56			SHGC(>1) 0.25				VT(>1) 0.28		CR 46		
804	Outswing w/ Kickplate - 3 Vertical TDs: SNX 5123 / Arg / 3mmClr-030PVB-3mmIS20 - 28mm (6mm-6mm)											
	0.221	0.625	0.264					ARG90	0.021(#2) / 0.198(#4)	CL	TS-D	T
	U-Factor 0.45			SHGC(>1) 0.11				VT(>1) 0.20		CR 51		
805	Outswing w/ Kickplate - 4 Vertical TDs: SNX 5123 / Arg / Clr - 28mm(6mm-6mm)											
	0.221	0.630	0.224					ARG90	0.021(#2)	CL	A1-D	T
	U-Factor 0.60			SHGC(>1) 0.12				VT(>1) 0.21		CR 48		
806	Outswing w/ Kickplate - 4 Vertical TDs: SNX 6227 / Arg / Clr - 28mm(6mm-6mm)											
	0.221	0.630	0.224					ARG90	0.020(#2)	CL	A1-D	T
	U-Factor 0.60			SHGC(>1) 0.13				VT(>1) 0.26		CR 48		
807	Outswing w/ Kickplate - 4 Vertical TDs: ClimaGuard Premium T / Arg / Clr - 27mm(6mm-5mm)											
	0.230	0.630	0.185					ARG90	0.035(#2)	CL	A1-D	T
	U-Factor 0.60			SHGC(>1) 0.23				VT(>1) 0.32		CR 48		
808	Outswing w/ Kickplate - 4 Vertical TDs: SN 4023 / Arg / Clr - 27mm(6mm-5mm)											
	0.230	0.630	0.185					ARG90	0.026(#2)	CL	A1-D	T
	U-Factor 0.60			SHGC(>1) 0.11				VT(>1) 0.16		CR 48		
809	Outswing w/ Kickplate - 4 Vertical TDs: SN 5128 / Arg / Clr - 27mm(6mm-5mm)											
	0.230	0.630	0.185					ARG90	0.025(#2)	CL	A1-D	T
	U-Factor 0.60			SHGC(>1) 0.13				VT(>1) 0.21		CR 48		
810	Outswing w/ Kickplate - 4 Vertical TDs: SN 6234 / Arg / Clr - 27mm(6mm-5mm)											
	0.230	0.630	0.185					ARG90	0.026(#2)	CL	A1-D	T
	U-Factor 0.60			SHGC(>1) 0.15				VT(>1) 0.26		CR 48		

TEST REPORT FOR NEON ENERGY USA INC.

Report No: K0461.02-301-45 R3

Date: 12/18/20

SECTION 6 (Continued)
SIMULATION RESULTS

TOTAL PRODUCT CALCULATIONS (Ultra Outswing and Inswing Door)												
Option Number	Pane Thickness 1 (in)	Gap Width 1 (in)	Pane Thickness 2 (in)	Gap Width 2 (in)	Pane Thickness 3 (in)	Gap Width 3 (in)	Pane Thickness 4 (in)	Gap Fill	Low-e (Surface #)	Tint	Spacer	Grid Type
	U-Factor (Btu/Hr-Ft2-F)			Solar Heat Gain Coefficient (SHGC) Grids (None / <1 / >=1)				Visible Transmittance (VT) Grids (None / <1 / >=1)		Condensation Resistance (CR)		
811	Outswing w/ Kickplate - 4 Vertical TDs: SN 7037 / Arg / Clr - 27mm(6mm-5mm)											
	0.230	0.630	0.185					ARG90	0.022(#2)	CL	A1-D	T
	U-Factor 0.60			SHGC(>1) 0.17				VT(>1) 0.29		CR 49		
812	Outswing w/ Kickplate - 4 Vertical TDs: ClimaGuard Neutral 70 / Arg / Clr - 27mm(6mm-5mm)											
	0.226	0.630	0.185					ARG90	0.171(#2)	CL	A1-D	T
	U-Factor 0.62			SHGC(>1) 0.25				VT(>1) 0.28		CR 47		
813	Outswing w/ Kickplate - 4 Vertical TDs: SNX 6227 / Arg / Clr - 24mm(4mm-4mm)											
	0.151	0.630	0.154					ARG90	0.020(#2)	CL	A1-D	T
	U-Factor 0.59			SHGC(>1) 0.13				VT(>1) 0.26		CR 50		
814	Outswing w/ Kickplate - 4 Vertical TDs: ClimaGuard Premium T / Arg / Clr - 24mm(4mm-4mm)											
	0.151	0.630	0.154					ARG90	0.035(#2)	CL	A1-D	T
	U-Factor 0.59			SHGC(>1) 0.24				VT(>1) 0.32		CR 49		
815	Outswing w/ Kickplate - 4 Vertical TDs: SN 4023 / Arg / Clr - 24mm(4mm-4mm)											
	0.151	0.630	0.154					ARG90	0.026(#2)	CL	A1-D	T
	U-Factor 0.59			SHGC(>1) 0.11				VT(>1) 0.17		CR 50		
816	Outswing w/ Kickplate - 4 Vertical TDs: SN 5128 / Arg / Clr - 24mm(4mm-4mm)											
	0.151	0.630	0.154					ARG90	0.025(#2)	CL	A1-D	T
	U-Factor 0.59			SHGC(>1) 0.13				VT(>1) 0.21		CR 50		
817	Outswing w/ Kickplate - 4 Vertical TDs: SN 6234 / Arg / Clr - 24mm(4mm-4mm)											
	0.151	0.630	0.154					ARG90	0.026(#2)	CL	A1-D	T
	U-Factor 0.59			SHGC(>1) 0.15				VT(>1) 0.26		CR 50		
818	Outswing w/ Kickplate - 4 Vertical TDs: SN 7037 / Arg / Clr - 24mm(4mm-4mm)											
	0.151	0.630	0.154					ARG90	0.022(#2)	CL	A1-D	T
	U-Factor 0.59			SHGC(>1) 0.17				VT(>1) 0.29		CR 50		
819	Outswing w/ Kickplate - 4 Vertical TDs: ClimaGuard Neutral 70 / Arg / Clr - 24mm(4mm-4mm)											
	0.148	0.630	0.154					ARG90	0.171(#2)	CL	A1-D	T
	U-Factor 0.61			SHGC(>1) 0.25				VT(>1) 0.29		CR 48		
820	Outswing w/ Kickplate - 4 Vertical TDs: ClimaGuard Neutral 70 / Arg / Clr - 28mm(6mm-5mm)											
	0.226	0.670	0.185					ARG90	0.171(#2)	CL	A1-D	T
	U-Factor 0.62			SHGC(>1) 0.25				VT(>1) 0.28		CR 47		

TEST REPORT FOR NEON ENERGY USA INC.

Report No: K0461.02-301-45 R3

Date: 12/18/20

SECTION 6 (Continued)

SIMULATION RESULTS

TOTAL PRODUCT CALCULATIONS (Ultra Outswing and Inswing Door)												
Option Number	Pane Thickness 1 (in)	Gap Width 1 (in)	Pane Thickness 2 (in)	Gap Width 2 (in)	Pane Thickness 3 (in)	Gap Width 3 (in)	Pane Thickness 4 (in)	Gap Fill	Low-e (Surface #)	Tint	Spacer	Grid Type
	U-Factor (Btu/Hr-Ft ² -F)			Solar Heat Gain Coefficient (SHGC) Grids (None / <1 / >=1)				Visible Transmittance (VT) Grids (None / <1 / >=1)		Condensation Resistance (CR)		
821	Outswing w/ Kickplate - 4 Vertical TDs: ClimaGuard Neutral 70 / Arg / Clr - 28mm(4mm-4mm)											
	0.226	0.787	0.185					ARG90	0.171(#2)	CL	A1-D	T
	U-Factor 0.63			SHGC(>1) 0.25				VT(>1) 0.28		CR 45		
822	Outswing w/ Kickplate - 4 Vertical TDs: SNX 5123 / Arg / 3mmClr-030PVB-3mmIS20 - 28mm (6mm-6mm)											
	0.221	0.625	0.264					ARG90	0.021(#2) / 0.198(#4)	CL	TS-D	T
	U-Factor 0.50			SHGC(>1) 0.11				VT(>1) 0.20		CR 51		
823	Outswing w/ Kickplate: SN 5128 / Arg / Climaguard Dry - 27mm(6mm-6mm)											
	0.230	0.590	0.230					ARG90	0.025(#2) / 0.200(#4)	CL	TP-D	N
	U-Factor 0.38			SHGC(N) 0.16				VT(N) 0.28		CR 51		
824	Outswing w/ Kickplate - SN 5128 / Arg / ClimaGurad Dry - 27mm(6mm-6mm): SN 5128 / Arg / Climaguard Dry - 27mm(6mm-6mm)											
	0.230	0.590	0.230					ARG90	0.025(#2) / 0.200(#4)	CL	TP-D	T
	U-Factor 0.48			SHGC(>1) 0.12				VT(>1) 0.20		CR 51		
825	Outswing w/ Kickplate - 1 Horizontal TDL: SN 5128 / Arg / Climaguard Dry - 27mm(6mm-6mm)											
	0.230	0.590	0.230					ARG90	0.025(#2) / 0.200(#4)	CL	TP-D	T
	U-Factor 0.39			SHGC(>1) 0.12				VT(>1) 0.20		CR 51		
826	Outswing w/ Kickplate - 2 Horizontal TDs: SN 5128 / Arg / Climaguard Dry - 27mm(6mm-6mm)											
	0.230	0.590	0.230					ARG90	0.025(#2) / 0.200(#4)	CL	TP-D	T
	U-Factor 0.40			SHGC(>1) 0.12				VT(>1) 0.20		CR 51		
827	Outswing w/ Kickplate - 3 Horizontal TDs: SN 5128 / Arg / Climaguard Dry - 27mm(6mm-6mm)											
	0.230	0.590	0.230					ARG90	0.025(#2) / 0.200(#4)	CL	TP-D	T
	U-Factor 0.40			SHGC(>1) 0.12				VT(>1) 0.20		CR 51		
828	Outswing w/ Kickplate - 4 Horizontal TDs: SN 5128 / Arg / Climaguard Dry - 27mm(6mm-6mm)											
	0.230	0.590	0.230					ARG90	0.025(#2) / 0.200(#4)	CL	TP-D	T
	U-Factor 0.41			SHGC(>1) 0.12				VT(>1) 0.20		CR 51		
829	Outswing w/ Kickplate - 1 Vertical TDL: SN 5128 / Arg / Climaguard Dry - 27mm(6mm-6mm)											
	0.230	0.590	0.230					ARG90	0.025(#2) / 0.200(#4)	CL	TP-D	T
	U-Factor 0.40			SHGC(>1) 0.12				VT(>1) 0.20		CR 51		
830	Outswing w/ Kickplate - 2 Vertical TDs: SN 5128 / Arg / Climaguard Dry - 27mm(6mm-6mm)											
	0.230	0.590	0.230					ARG90	0.025(#2) / 0.200(#4)	CL	TP-D	T
	U-Factor 0.42			SHGC(>1) 0.12				VT(>1) 0.20		CR 51		

TEST REPORT FOR NEON ENERGY USA INC.

Report No: K0461.02-301-45 R3

Date: 12/18/20

SECTION 6 (Continued) SIMULATION RESULTS

TOTAL PRODUCT CALCULATIONS (Ultra Outswing and Inswing Door)												
Option Number	Pane Thickness 1 (in)	Gap Width 1 (in)	Pane Thickness 2 (in)	Gap Width 2 (in)	Pane Thickness 3 (in)	Gap Width 3 (in)	Pane Thickness 4 (in)	Gap Fill	Low-e (Surface #)	Tint	Spacer	Grid Type
	U-Factor (Btu/Hr-Ft2-F)			Solar Heat Gain Coefficient (SHGC) Grids (None / <1 / >=1)				Visible Transmittance (VT) Grids (None / <1 / >=1)		Condensation Resistance (CR)		
831	Outswing w/ Kickplate - 3 Vertical TDs: SN 5128 / Arg / Climaguard Dry - 27mm(6mm-6mm)											
	0.230	0.590	0.230					ARG90	0.025(#2) / 0.200(#4)	CL	TP-D	T
	U-Factor 0.44			SHGC(>1) 0.12				VT(>1) 0.20		CR 51		
832	Outswing w/ Kickplate - 4 Vertical TDs: SN 5128 / Arg / Climaguard Dry - 27mm(6mm-6mm)											
	0.230	0.590	0.230					ARG90	0.025(#2) / 0.200(#4)	CL	TP-D	T
	U-Factor 0.48			SHGC(>1) 0.12				VT(>1) 0.20		CR 51		
833	Outswing w/ Kickplate: SN 5128 / Arg / IS20 - 27mm(6mm-6mm)											
	0.230	0.590	0.221					ARG90	0.025(#2) / 0.198(#4)	CL	TP-D	N
	U-Factor 0.38			SHGC(N) 0.16				VT(N) 0.28		CR 51		
834	Outswing w/ Kickplate - SN 5128 / Arg / IS20 - 27mm(6mm-6mm): SN 5128 / Arg / IS20 - 27mm(6mm-6mm)											
	0.230	0.590	0.221					ARG90	0.025(#2) / 0.198(#4)	CL	TP-D	T
	U-Factor 0.48			SHGC(>1) 0.12				VT(>1) 0.20		CR 51		
835	Outswing w/ Kickplate - 1 Horizontal TDL: SN 5128 / Arg / IS20 - 27mm(6mm-6mm)											
	0.230	0.590	0.221					ARG90	0.025(#2) / 0.198(#4)	CL	TP-D	T
	U-Factor 0.39			SHGC(>1) 0.12				VT(>1) 0.20		CR 51		
836	Outswing w/ Kickplate - 2 Horizontal TDs: SN 5128 / Arg / IS20 - 27mm(6mm-6mm)											
	0.230	0.590	0.221					ARG90	0.025(#2) / 0.198(#4)	CL	TP-D	T
	U-Factor 0.39			SHGC(>1) 0.12				VT(>1) 0.20		CR 51		
837	Outswing w/ Kickplate - 3 Horizontal TDs: SN 5128 / Arg / IS20 - 27mm(6mm-6mm)											
	0.230	0.590	0.221					ARG90	0.025(#2) / 0.198(#4)	CL	TP-D	T
	U-Factor 0.40			SHGC(>1) 0.12				VT(>1) 0.20		CR 51		
838	Outswing w/ Kickplate - 4 Horizontal TDs: SN 5128 / Arg / IS20 - 27mm(6mm-6mm)											
	0.230	0.590	0.221					ARG90	0.025(#2) / 0.198(#4)	CL	TP-D	T
	U-Factor 0.41			SHGC(>1) 0.12				VT(>1) 0.20		CR 51		
839	Outswing w/ Kickplate - 1 Vertical TDL: SN 5128 / Arg / IS20 - 27mm(6mm-6mm)											
	0.230	0.590	0.221					ARG90	0.025(#2) / 0.198(#4)	CL	TP-D	T
	U-Factor 0.40			SHGC(>1) 0.12				VT(>1) 0.20		CR 51		
840	Outswing w/ Kickplate - 2 Vertical TDs: SN 5128 / Arg / IS20 - 27mm(6mm-6mm)											
	0.230	0.590	0.221					ARG90	0.025(#2) / 0.198(#4)	CL	TP-D	T
	U-Factor 0.42			SHGC(>1) 0.12				VT(>1) 0.20		CR 51		

TEST REPORT FOR NEON ENERGY USA INC.

Report No: K0461.02-301-45 R3

Date: 12/18/20

SECTION 6 (Continued)

SIMULATION RESULTS

TOTAL PRODUCT CALCULATIONS (Ultra Outswing and Inswing Door)												
Option Number	Pane Thickness 1 (in)	Gap Width 1 (in)	Pane Thickness 2 (in)	Gap Width 2 (in)	Pane Thickness 3 (in)	Gap Width 3 (in)	Pane Thickness 4 (in)	Gap Fill	Low-e (Surface #)	Tint	Spacer	Grid Type
	U-Factor (Btu/Hr-Ft2-F)			Solar Heat Gain Coefficient (SHGC) Grids (None / <1 / >=1)				Visible Transmittance (VT) Grids (None / <1 / >=1)		Condensation Resistance (CR)		
841	Outswing w/ Kickplate - 3 Vertical TDLS: SN 5128 / Arg / IS20 - 27mm(6mm-6mm)											
	0.230	0.590	0.221					ARG90	0.025(#2) / 0.198(#4)	CL	TP-D	T
	U-Factor 0.44			SHGC(>1) 0.12				VT(>1) 0.20		CR 51		
842	Outswing w/ Kickplate - 4 Vertical TDLS: SN 5128 / Arg / IS20 - 27mm(6mm-6mm)											
	0.230	0.590	0.221					ARG90	0.025(#2) / 0.198(#4)	CL	TP-D	T
	U-Factor 0.48			SHGC(>1) 0.12				VT(>1) 0.20		CR 51		
843	Outswing w/ Kickplate: 4mm-076PVB-4mmPlanistar / Arg / 3mmClr-076PVB-3mmClr - 28mm(8mm-6mm)											
	0.384	0.391	0.311					ARG90	0.026(#2)	CL	A1-D	N
	U-Factor 0.41			SHGC(N) 0.21				VT(N) 0.39		CR 50		
844	Outswing w/ Kickplate - 4mm-076PVB-4mmPlanistar / Arg / 3mmClr-076PVB-3mmClr - 28mm(8mm-6mm); 4mm-076PVB-4mmPlanistar / Arg / 3mmClr-076PVB-3mmClr - 28mm(8mm-6mm)											
	0.384	0.391	0.311					ARG90	0.026(#2)	CL	A1-D	T
	U-Factor 0.55			SHGC(>1) 0.16				VT(>1) 0.28		CR 50		
845	Outswing w/ Kickplate - 1 Horizontal TDLS: 4mm-076PVB-4mmPlanistar / Arg / 3mmClr-076PVB-3mmClr - 28mm(8mm-6mm)											
	0.384	0.391	0.311					ARG90	0.026(#2)	CL	A1-D	T
	U-Factor 0.43			SHGC(>1) 0.16				VT(>1) 0.28		CR 50		
846	Outswing w/ Kickplate - 2 Horizontal TDLS: 4mm-076PVB-4mmPlanistar / Arg / 3mmClr-076PVB-3mmClr - 28mm(8mm-6mm)											
	0.384	0.391	0.311					ARG90	0.026(#2)	CL	A1-D	T
	U-Factor 0.44			SHGC(>1) 0.16				VT(>1) 0.28		CR 50		
847	Outswing w/ Kickplate - 3 Horizontal TDLS: 4mm-076PVB-4mmPlanistar / Arg / 3mmClr-076PVB-3mmClr - 28mm(8mm-6mm)											
	0.384	0.391	0.311					ARG90	0.026(#2)	CL	A1-D	T
	U-Factor 0.45			SHGC(>1) 0.16				VT(>1) 0.28		CR 50		
848	Outswing w/ Kickplate - 4 Horizontal TDLS: 4mm-076PVB-4mmPlanistar / Arg / 3mmClr-076PVB-3mmClr - 28mm(8mm-6mm)											
	0.384	0.391	0.311					ARG90	0.026(#2)	CL	A1-D	T
	U-Factor 0.47			SHGC(>1) 0.16				VT(>1) 0.28		CR 50		
849	Outswing w/ Kickplate - 1 Vertical TDLS: 4mm-076PVB-4mmPlanistar / Arg / 3mmClr-076PVB-3mmClr - 28mm(8mm-6mm)											
	0.384	0.391	0.311					ARG90	0.026(#2)	CL	A1-D	T
	U-Factor 0.45			SHGC(>1) 0.16				VT(>1) 0.28		CR 50		
850	Outswing w/ Kickplate - 2 Vertical TDLS: 4mm-076PVB-4mmPlanistar / Arg / 3mmClr-076PVB-3mmClr - 28mm(8mm-6mm)											
	0.384	0.391	0.311					ARG90	0.026(#2)	CL	A1-D	T
	U-Factor 0.48			SHGC(>1) 0.16				VT(>1) 0.28		CR 50		

TEST REPORT FOR NEON ENERGY USA INC.

Report No: K0461.02-301-45 R3

Date: 12/18/20

SECTION 6 (Continued)

SIMULATION RESULTS

TOTAL PRODUCT CALCULATIONS (Ultra Outswing and Inswing Door)												
Option Number	Pane Thickness 1 (in)	Gap Width 1 (in)	Pane Thickness 2 (in)	Gap Width 2 (in)	Pane Thickness 3 (in)	Gap Width 3 (in)	Pane Thickness 4 (in)	Gap Fill	Low-e (Surface #)	Tint	Spacer	Grid Type
	U-Factor (Btu/Hr-Ft2-F)			Solar Heat Gain Coefficient (SHGC) Grids (None / <1 / >=1)				Visible Transmittance (VT) Grids (None / <1 / >=1)		Condensation Resistance (CR)		
851	Outswing w/ Kickplate - 3 Vertical TDLS: 4mm-076PVB-4mmPlanistar / Arg / 3mmClr-076PVB-3mmClr - 28mm(8mm-6mm)											
	0.384	0.391	0.311					ARG90	0.026(#2)	CL	A1-D	T
	U-Factor 0.51			SHGC(>1) 0.16				VT(>1) 0.28		CR 50		
852	Outswing w/ Kickplate - 4 Vertical TDLS: 4mm-076PVB-4mmPlanistar / Arg / 3mmClr-076PVB-3mmClr - 28mm(8mm-6mm)											
	0.384	0.391	0.311					ARG90	0.026(#2)	CL	A1-D	T
	U-Factor 0.57			SHGC(>1) 0.16				VT(>1) 0.28		CR 50		
853	Inswing: SN 7037 / Arg / IS20 - 28mm(6mm-6mm)											
	0.230	0.630	0.221					ARG90	0.022(#2) / 0.198(#4)	CL	TP-D	N
	U-Factor 0.32			SHGC (N) 0.24				VT (N) 0.47		CR 51		
854	Inswing - 1 Horizontal TDL: SN 7037 / Arg / IS20 - 28mm(6mm-6mm)											
	0.230	0.630	0.221					ARG90	0.022(#2) / 0.198(#4)	CL	TP-D	T
	U-Factor 0.33			SHGC (>1) 0.19				VT (>1) 0.35		CR 51		
855	Inswing - 2 Horizontal TDLS: SN 7037 / Arg / IS20 - 28mm(6mm-6mm)											
	0.230	0.630	0.221					ARG90	0.022(#2) / 0.198(#4)	CL	TP-D	T
	U-Factor 0.34			SHGC (>1) 0.19				VT (>1) 0.35		CR 51		
856	Inswing - 3 Horizontal TDLS: SN 7037 / Arg / IS20 - 28mm(6mm-6mm)											
	0.230	0.630	0.221					ARG90	0.022(#2) / 0.198(#4)	CL	TP-D	T
	U-Factor 0.35			SHGC (>1) 0.19				VT (>1) 0.35		CR 51		
857	Inswing - 4 Horizontal TDLS: SN 7037 / Arg / IS20 - 28mm(6mm-6mm)											
	0.230	0.630	0.221					ARG90	0.022(#2) / 0.198(#4)	CL	TP-D	T
	U-Factor 0.36			SHGC (>1) 0.19				VT (>1) 0.35		CR 51		
858	Inswing - 1 Vertical TDL: SN 7037 / Arg / IS20 - 28mm(6mm-6mm)											
	0.230	0.630	0.221					ARG90	0.022(#2) / 0.198(#4)	CL	TP-D	T
	U-Factor 0.35			SHGC (>1) 0.19				VT (>1) 0.35		CR 51		
859	Inswing - 2 Vertical TDLS: SN 7037 / Arg / IS20 - 28mm(6mm-6mm)											
	0.230	0.630	0.221					ARG90	0.022(#2) / 0.198(#4)	CL	TP-D	T
	U-Factor 0.37			SHGC (>1) 0.19				VT (>1) 0.35		CR 51		
860	Inswing - 3 Vertical TDLS: SN 7037 / Arg / IS20 - 28mm(6mm-6mm)											
	0.230	0.630	0.221					ARG90	0.022(#2) / 0.198(#4)	CL	TP-D	T
	U-Factor 0.39			SHGC (>1) 0.19				VT (>1) 0.35		CR 51		

TEST REPORT FOR NEON ENERGY USA INC.

Report No: K0461.02-301-45 R3

Date: 12/18/20

SECTION 6 (Continued)

SIMULATION RESULTS

TOTAL PRODUCT CALCULATIONS (Ultra Outswing and Inswing Door)												
Option Number	Pane Thickness 1 (in)	Gap Width 1 (in)	Pane Thickness 2 (in)	Gap Width 2 (in)	Pane Thickness 3 (in)	Gap Width 3 (in)	Pane Thickness 4 (in)	Gap Fill	Low-e (Surface #)	Tint	Spacer	Grid Type
	U-Factor (Btu/Hr-Ft ² -F)			Solar Heat Gain Coefficient (SHGC) Grids (None / <1 / >=1)				Visible Transmittance (VT) Grids (None / <1 / >=1)		Condensation Resistance (CR)		
861	Inswing - 4 Vertical TDLS: SN 7037 / Arg / IS20 - 28mm(6mm-6mm)											
	0.230	0.630	0.221					ARG90	0.022(#2) / 0.198(#4)	CL	TP-D	T
	U-Factor 0.44			SHGC (>1) 0.19				VT (>1) 0.35		CR 51		
862	Inswing: SN 5128 / Arg / Clr - 28mm(6mm-6mm)											
	0.230	0.630	0.224					ARG90	0.025(#2)	CL	TP-D	N
	U-Factor 0.35			SHGC (N) 0.19				VT (N) 0.35		CR 51		
863	Inswing - 1 Horizontal TDLS: SN 5128 / Arg / Clr - 28mm(6mm-6mm)											
	0.230	0.630	0.224					ARG90	0.025(#2)	CL	TP-D	T
	U-Factor 0.36			SHGC (>1) 0.15				VT (>1) 0.26		CR 51		
864	Inswing - 2 Horizontal TDLS: SN 5128 / Arg / Clr - 28mm(6mm-6mm)											
	0.230	0.630	0.224					ARG90	0.025(#2)	CL	TP-D	T
	U-Factor 0.37			SHGC (>1) 0.15				VT (>1) 0.26		CR 51		
865	Inswing - 3 Horizontal TDLS: SN 5128 / Arg / Clr - 28mm(6mm-6mm)											
	0.230	0.630	0.224					ARG90	0.025(#2)	CL	TP-D	T
	U-Factor 0.38			SHGC (>1) 0.15				VT (>1) 0.26		CR 51		
866	Inswing - 4 Horizontal TDLS: SN 5128 / Arg / Clr - 28mm(6mm-6mm)											
	0.230	0.630	0.224					ARG90	0.025(#2)	CL	TP-D	T
	U-Factor 0.38			SHGC (>1) 0.15				VT (>1) 0.26		CR 51		
867	Inswing - 1 Vertical TDLS: SN 5128 / Arg / Clr - 28mm(6mm-6mm)											
	0.230	0.630	0.224					ARG90	0.025(#2)	CL	TP-D	T
	U-Factor 0.37			SHGC (>1) 0.15				VT (>1) 0.26		CR 51		
868	Inswing - 2 Vertical TDLS: SN 5128 / Arg / Clr - 28mm(6mm-6mm)											
	0.230	0.630	0.224					ARG90	0.025(#2)	CL	TP-D	T
	U-Factor 0.39			SHGC (>1) 0.15				VT (>1) 0.26		CR 51		
869	Inswing - 3 Vertical TDLS: SN 5128 / Arg / Clr - 28mm(6mm-6mm)											
	0.230	0.630	0.224					ARG90	0.025(#2)	CL	TP-D	T
	U-Factor 0.41			SHGC (>1) 0.15				VT (>1) 0.26		CR 51		
870	Inswing - 4 Vertical TDLS: SN 5128 / Arg / Clr - 28mm(6mm-6mm)											
	0.230	0.630	0.224					ARG90	0.025(#2)	CL	TP-D	T
	U-Factor 0.46			SHGC (>1) 0.15				VT (>1) 0.26		CR 51		

TEST REPORT FOR NEON ENERGY USA INC.

Report No: K0461.02-301-45 R3

Date: 12/18/20

SECTION 6 (Continued)

SIMULATION RESULTS

TOTAL PRODUCT CALCULATIONS (Ultra Outswing and Inswing Door)												
Option Number	Pane Thickness 1 (in)	Gap Width 1 (in)	Pane Thickness 2 (in)	Gap Width 2 (in)	Pane Thickness 3 (in)	Gap Width 3 (in)	Pane Thickness 4 (in)	Gap Fill	Low-e (Surface #)	Tint	Spacer	Grid Type
	U-Factor (Btu/Hr-Ft2-F)			Solar Heat Gain Coefficient (SHGC) Grids (None / <1 / >=1)				Visible Transmittance (VT) Grids (None / <1 / >=1)		Condensation Resistance (CR)		
871	Inswing: SN 7037 / Arg / Clr - 28mm(6mm-6mm)											
	0.230	0.630	0.224					ARG90	0.022(#2)	CL	TP-D	N
	U-Factor 0.35			SHGC (N) 0.25				VT (N) 0.49		CR 51		
872	Inswing - 1 Horizontal TDL: SN 7037 / Arg / Clr - 28mm(6mm-6mm)											
	0.230	0.630	0.224					ARG90	0.022(#2)	CL	TP-D	T
	U-Factor 0.36			SHGC (>1) 0.19				VT (>1) 0.36		CR 51		
873	Inswing - 2 Horizontal TDLs: SN 7037 / Arg / Clr - 28mm(6mm-6mm)											
	0.230	0.630	0.224					ARG90	0.022(#2)	CL	TP-D	T
	U-Factor 0.37			SHGC (>1) 0.19				VT (>1) 0.36		CR 51		
874	Inswing - 3 Horizontal TDLs: SN 7037 / Arg / Clr - 28mm(6mm-6mm)											
	0.230	0.630	0.224					ARG90	0.022(#2)	CL	TP-D	T
	U-Factor 0.37			SHGC (>1) 0.19				VT (>1) 0.36		CR 51		
875	Inswing - 4 Horizontal TDLs: SN 7037 / Arg / Clr - 28mm(6mm-6mm)											
	0.230	0.630	0.224					ARG90	0.022(#2)	CL	TP-D	T
	U-Factor 0.38			SHGC (>1) 0.19				VT (>1) 0.36		CR 51		
876	Inswing - 1 Vertical TDL: SN 7037 / Arg / Clr - 28mm(6mm-6mm)											
	0.230	0.630	0.224					ARG90	0.022(#2)	CL	TP-D	T
	U-Factor 0.37			SHGC (>1) 0.19				VT (>1) 0.36		CR 51		
877	Inswing - 2 Vertical TDLs: SN 7037 / Arg / Clr - 28mm(6mm-6mm)											
	0.230	0.630	0.224					ARG90	0.022(#2)	CL	TP-D	T
	U-Factor 0.39			SHGC (>1) 0.19				VT (>1) 0.36		CR 51		
878	Inswing - 3 Vertical TDLs: SN 7037 / Arg / Clr - 28mm(6mm-6mm)											
	0.230	0.630	0.224					ARG90	0.022(#2)	CL	TP-D	T
	U-Factor 0.41			SHGC (>1) 0.19				VT (>1) 0.36		CR 51		
879	Inswing - 4 Vertical TDLs: SN 7037 / Arg / Clr - 28mm(6mm-6mm)											
	0.230	0.630	0.224					ARG90	0.022(#2)	CL	TP-D	T
	U-Factor 0.46			SHGC (>1) 0.19				VT (>1) 0.36		CR 51		
880	Inswing w/ Kickplate: SN 7037 / Arg / IS20 - 28mm(6mm-6mm)											
	0.230	0.630	0.221					ARG90	0.022(#2) / 0.198(#4)	CL	TP-D	N
	U-Factor 0.36			SHGC (N) 0.23				VT (N) 0.43		CR 48		

TEST REPORT FOR NEON ENERGY USA INC.

Report No: K0461.02-301-45 R3

Date: 12/18/20

SECTION 6 (Continued)

SIMULATION RESULTS

TOTAL PRODUCT CALCULATIONS (Ultra Outswing and Inswing Door)												
Option Number	Pane Thickness 1 (in)	Gap Width 1 (in)	Pane Thickness 2 (in)	Gap Width 2 (in)	Pane Thickness 3 (in)	Gap Width 3 (in)	Pane Thickness 4 (in)	Gap Fill	Low-e (Surface #)	Tint	Spacer	Grid Type
	U-Factor (Btu/Hr-Ft2-F)			Solar Heat Gain Coefficient (SHGC) Grids (None / <1 / >=1)				Visible Transmittance (VT) Grids (None / <1 / >=1)		Condensation Resistance (CR)		
881	Inswing w/ Kickplate - 1 Horizontal TDL: SN 7037 / Arg / IS20 - 28mm(6mm-6mm)											
	0.230	0.630	0.221					ARG90	0.022(#2) / 0.198(#4)	CL	TP-D	T
	U-Factor 0.37			SHGC (>1) 0.18				VT (>1) 0.32		CR 48		
882	Inswing w/ Kickplate - 2 Horizontal TDLs: SN 7037 / Arg / IS20 - 28mm(6mm-6mm)											
	0.230	0.630	0.221					ARG90	0.022(#2) / 0.198(#4)	CL	TP-D	T
	U-Factor 0.38			SHGC (>1) 0.18				VT (>1) 0.32		CR 48		
883	Inswing w/ Kickplate - 3 Horizontal TDLs: SN 7037 / Arg / IS20 - 28mm(6mm-6mm)											
	0.230	0.630	0.221					ARG90	0.022(#2) / 0.198(#4)	CL	TP-D	T
	U-Factor 0.38			SHGC (>1) 0.18				VT (>1) 0.32		CR 48		
884	Inswing w/ Kickplate - 4 Horizontal TDLs: SN 7037 / Arg / IS20 - 28mm(6mm-6mm)											
	0.230	0.630	0.221					ARG90	0.022(#2) / 0.198(#4)	CL	TP-D	T
	U-Factor 0.39			SHGC (>1) 0.18				VT (>1) 0.32		CR 48		
885	Inswing w/ Kickplate - 1 Vertical TDL: SN 7037 / Arg / IS20 - 28mm(6mm-6mm)											
	0.230	0.630	0.221					ARG90	0.022(#2) / 0.198(#4)	CL	TP-D	T
	U-Factor 0.38			SHGC (>1) 0.18				VT (>1) 0.32		CR 48		
886	Inswing w/ Kickplate - 2 Vertical TDLs: SN 7037 / Arg / IS20 - 28mm(6mm-6mm)											
	0.230	0.630	0.221					ARG90	0.022(#2) / 0.198(#4)	CL	TP-D	T
	U-Factor 0.40			SHGC (>1) 0.18				VT (>1) 0.32		CR 48		
887	Inswing w/ Kickplate - 3 Vertical TDLs: SN 7037 / Arg / IS20 - 28mm(6mm-6mm)											
	0.230	0.630	0.221					ARG90	0.022(#2) / 0.198(#4)	CL	TP-D	T
	U-Factor 0.42			SHGC (>1) 0.18				VT (>1) 0.32		CR 48		
888	Inswing w/ Kickplate - 4 Vertical TDLs: SN 7037 / Arg / IS20 - 28mm(6mm-6mm)											
	0.230	0.630	0.221					ARG90	0.022(#2) / 0.198(#4)	CL	TP-D	T
	U-Factor 0.46			SHGC (>1) 0.18				VT (>1) 0.32		CR 48		
889	Inswing w/ Kickplate: SN 5128 / Arg / Clr - 28mm(6mm-6mm)											
	0.230	0.630	0.224					ARG90	0.025(#2)	CL	TP-D	N
	U-Factor 0.39			SHGC (N) 0.18				VT (N) 0.32		CR 49		
890	Inswing w/ Kickplate - 1 Horizontal TDL: SN 5128 / Arg / Clr - 28mm(6mm-6mm)											
	0.230	0.630	0.224					ARG90	0.025(#2)	CL	TP-D	T
	U-Factor 0.39			SHGC (>1) 0.14				VT (>1) 0.24		CR 49		

TEST REPORT FOR NEON ENERGY USA INC.

Report No: K0461.02-301-45 R3

Date: 12/18/20

SECTION 6 (Continued) SIMULATION RESULTS

TOTAL PRODUCT CALCULATIONS (Ultra Outswing and Inswing Door)												
Option Number	Pane Thickness 1 (in)	Gap Width 1 (in)	Pane Thickness 2 (in)	Gap Width 2 (in)	Pane Thickness 3 (in)	Gap Width 3 (in)	Pane Thickness 4 (in)	Gap Fill	Low-e (Surface #)	Tint	Spacer	Grid Type
	U-Factor (Btu/Hr-Ft2-F)			Solar Heat Gain Coefficient (SHGC) Grids (None / <1 / >=1)				Visible Transmittance (VT) Grids (None / <1 / >=1)		Condensation Resistance (CR)		
891	Inswing w/ Kickplate - 2 Horizontal TDLS: SN 5128 / Arg / Clr - 28mm(6mm-6mm)											
	0.230	0.630	0.224					ARG90	0.025(#2)	CL	TP-D	T
	U-Factor 0.40			SHGC (>1) 0.14				VT (>1) 0.24		CR 49		
892	Inswing w/ Kickplate - 3 Horizontal TDLS: SN 5128 / Arg / Clr - 28mm(6mm-6mm)											
	0.230	0.630	0.224					ARG90	0.025(#2)	CL	TP-D	T
	U-Factor 0.41			SHGC (>1) 0.14				VT (>1) 0.24		CR 49		
893	Inswing w/ Kickplate - 4 Horizontal TDLS: SN 5128 / Arg / Clr - 28mm(6mm-6mm)											
	0.230	0.630	0.224					ARG90	0.025(#2)	CL	TP-D	T
	U-Factor 0.41			SHGC (>1) 0.14				VT (>1) 0.24		CR 49		
894	Inswing w/ Kickplate - 1 Vertical TDLS: SN 5128 / Arg / Clr - 28mm(6mm-6mm)											
	0.230	0.630	0.224					ARG90	0.025(#2)	CL	TP-D	T
	U-Factor 0.40			SHGC (>1) 0.14				VT (>1) 0.24		CR 49		
895	Inswing w/ Kickplate - 2 Vertical TDLS: SN 5128 / Arg / Clr - 28mm(6mm-6mm)											
	0.230	0.630	0.224					ARG90	0.025(#2)	CL	TP-D	T
	U-Factor 0.42			SHGC (>1) 0.14				VT (>1) 0.24		CR 49		
896	Inswing w/ Kickplate - 3 Vertical TDLS: SN 5128 / Arg / Clr - 28mm(6mm-6mm)											
	0.230	0.630	0.224					ARG90	0.025(#2)	CL	TP-D	T
	U-Factor 0.44			SHGC (>1) 0.14				VT (>1) 0.24		CR 49		
897	Inswing w/ Kickplate - 4 Vertical TDLS: SN 5128 / Arg / Clr - 28mm(6mm-6mm)											
	0.230	0.630	0.224					ARG90	0.025(#2)	CL	TP-D	T
	U-Factor 0.48			SHGC (>1) 0.14				VT (>1) 0.24		CR 49		
898	Inswing w/ Kickplate: SN 7037 / Arg / Clr - 28mm(6mm-6mm)											
	0.230	0.630	0.224					ARG90	0.022(#2)	CL	TP-D	N
	U-Factor 0.39			SHGC (N) 0.23				VT (N) 0.44		CR 49		
899	Inswing w/ Kickplate - 1 Horizontal TDLS: SN 7037 / Arg / Clr - 28mm(6mm-6mm)											
	0.230	0.630	0.224					ARG90	0.022(#2)	CL	TP-D	T
	U-Factor 0.39			SHGC (>1) 0.18				VT (>1) 0.33		CR 49		
900	Inswing w/ Kickplate - 2 Horizontal TDLS: SN 7037 / Arg / Clr - 28mm(6mm-6mm)											
	0.230	0.630	0.224					ARG90	0.022(#2)	CL	TP-D	T
	U-Factor 0.40			SHGC (>1) 0.18				VT (>1) 0.33		CR 49		

TEST REPORT FOR NEON ENERGY USA INC.

Report No: K0461.02-301-45 R3

Date: 12/18/20

SECTION 6 (Continued) SIMULATION RESULTS

TOTAL PRODUCT CALCULATIONS (Ultra Outswing and Inswing Door)												
Option Number	Pane Thickness 1 (in)	Gap Width 1 (in)	Pane Thickness 2 (in)	Gap Width 2 (in)	Pane Thickness 3 (in)	Gap Width 3 (in)	Pane Thickness 4 (in)	Gap Fill	Low-e (Surface #)	Tint	Spacer	Grid Type
	U-Factor (Btu/Hr-Ft ² -F)			Solar Heat Gain Coefficient (SHGC) Grids (None / <1 / >=1)				Visible Transmittance (VT) Grids (None / <1 / >=1)		Condensation Resistance (CR)		
901	Inswing w/ Kickplate - 3 Horizontal TDLS: SN 7037 / Arg / Clr - 28mm(6mm-6mm)											
	0.230	0.630	0.224					ARG90	0.022(#2)	CL	TP-D	T
	U-Factor 0.41			SHGC (>1) 0.18				VT (>1) 0.33		CR 49		
902	Inswing w/ Kickplate - 4 Horizontal TDLS: SN 7037 / Arg / Clr - 28mm(6mm-6mm)											
	0.230	0.630	0.224					ARG90	0.022(#2)	CL	TP-D	T
	U-Factor 0.41			SHGC (>1) 0.18				VT (>1) 0.33		CR 49		
903	Inswing w/ Kickplate - 1 Vertical TDLS: SN 7037 / Arg / Clr - 28mm(6mm-6mm)											
	0.230	0.630	0.224					ARG90	0.022(#2)	CL	TP-D	T
	U-Factor 0.40			SHGC (>1) 0.18				VT (>1) 0.33		CR 49		
904	Inswing w/ Kickplate - 2 Vertical TDLS: SN 7037 / Arg / Clr - 28mm(6mm-6mm)											
	0.230	0.630	0.224					ARG90	0.022(#2)	CL	TP-D	T
	U-Factor 0.42			SHGC (>1) 0.18				VT (>1) 0.33		CR 49		
905	Inswing w/ Kickplate - 3 Vertical TDLS: SN 7037 / Arg / Clr - 28mm(6mm-6mm)											
	0.230	0.630	0.224					ARG90	0.022(#2)	CL	TP-D	T
	U-Factor 0.44			SHGC (>1) 0.18				VT (>1) 0.33		CR 49		
906	Inswing w/ Kickplate - 4 Vertical TDLS: SN 7037 / Arg / Clr - 28mm(6mm-6mm)											
	0.230	0.630	0.224					ARG90	0.022(#2)	CL	TP-D	T
	U-Factor 0.48			SHGC (>1) 0.18				VT (>1) 0.33		CR 49		
907	Outswing: SN 7037 / Arg / IS20 - 28mm(6mm-6mm)											
	0.230	0.630	0.221					ARG90	0.022(#2) / 0.198(#4)	CL	TP-D	N
	U-Factor 0.34			SHGC(N) 0.23				VT(N) 0.42		CR 50		
908	Outswing - 1 Horizontal TDLS: SN 7037 / Arg / IS20 - 28mm(6mm-6mm)											
	0.230	0.630	0.221					ARG90	0.022(#2) / 0.198(#4)	CL	TP-D	T
	U-Factor 0.35			SHGC(>1) 0.17				VT(>1) 0.31		CR 50		
909	Outswing - 2 Horizontal TDLS: SN 7037 / Arg / IS20 - 28mm(6mm-6mm)											
	0.230	0.630	0.221					ARG90	0.022(#2) / 0.198(#4)	CL	TP-D	T
	U-Factor 0.36			SHGC(>1) 0.17				VT(>1) 0.31		CR 50		
910	Outswing - 3 Horizontal TDLS: SN 7037 / Arg / IS20 - 28mm(6mm-6mm)											
	0.230	0.630	0.221					ARG90	0.022(#2) / 0.198(#4)	CL	TP-D	T
	U-Factor 0.37			SHGC(>1) 0.17				VT(>1) 0.31		CR 50		

TEST REPORT FOR NEON ENERGY USA INC.

Report No: K0461.02-301-45 R3

Date: 12/18/20

SECTION 6 (Continued)

SIMULATION RESULTS

TOTAL PRODUCT CALCULATIONS (Ultra Outswing and Inswing Door)												
Option Number	Pane Thickness 1 (in)	Gap Width 1 (in)	Pane Thickness 2 (in)	Gap Width 2 (in)	Pane Thickness 3 (in)	Gap Width 3 (in)	Pane Thickness 4 (in)	Gap Fill	Low-e (Surface #)	Tint	Spacer	Grid Type
	U-Factor (Btu/Hr-Ft2-F)			Solar Heat Gain Coefficient (SHGC) Grids (None / <1 / >=1)				Visible Transmittance (VT) Grids (None / <1 / >=1)		Condensation Resistance (CR)		
911	Outswing - 4 Horizontal TDLS: SN 7037 / Arg / IS20 - 28mm(6mm-6mm)											
	0.230	0.630	0.221					ARG90	0.022(#2) / 0.198(#4)	CL	TP-D	T
	U-Factor 0.38			SHGC(>1) 0.17				VT(>1) 0.31		CR 50		
912	Outswing - 1 Vertical TDLS: SN 7037 / Arg / IS20 - 28mm(6mm-6mm)											
	0.230	0.630	0.221					ARG90	0.022(#2) / 0.198(#4)	CL	TP-D	T
	U-Factor 0.37			SHGC(>1) 0.17				VT(>1) 0.31		CR 50		
913	Outswing - 2 Vertical TDLS: SN 7037 / Arg / IS20 - 28mm(6mm-6mm)											
	0.230	0.630	0.221					ARG90	0.022(#2) / 0.198(#4)	CL	TP-D	T
	U-Factor 0.39			SHGC(>1) 0.17				VT(>1) 0.31		CR 50		
914	Outswing - 3 Vertical TDLS: SN 7037 / Arg / IS20 - 28mm(6mm-6mm)											
	0.230	0.630	0.221					ARG90	0.022(#2) / 0.198(#4)	CL	TP-D	T
	U-Factor 0.41			SHGC(>1) 0.17				VT(>1) 0.31		CR 50		
915	Outswing - 4 Vertical TDLS: SN 7037 / Arg / IS20 - 28mm(6mm-6mm)											
	0.230	0.630	0.221					ARG90	0.022(#2) / 0.198(#4)	CL	TP-D	T
	U-Factor 0.46			SHGC(>1) 0.17				VT(>1) 0.31		CR 50		
916	Outswing: SN 5128 / Arg / Clr - 28mm(6mm-6mm)											
	0.230	0.630	0.224					ARG90	0.025(#2)	CL	TP-D	N
	U-Factor 0.38			SHGC(N) 0.17				VT(N) 0.32		CR 56		
917	Outswing - 1 Horizontal TDLS: SN 5128 / Arg / Clr - 28mm(6mm-6mm)											
	0.230	0.630	0.224					ARG90	0.025(#2)	CL	TP-D	T
	U-Factor 0.38			SHGC(>1) 0.14				VT(>1) 0.23		CR 56		
918	Outswing - 2 Horizontal TDLS: SN 5128 / Arg / Clr - 28mm(6mm-6mm)											
	0.230	0.630	0.224					ARG90	0.025(#2)	CL	TP-D	T
	U-Factor 0.39			SHGC(>1) 0.14				VT(>1) 0.23		CR 56		
919	Outswing - 3 Horizontal TDLS: SN 5128 / Arg / Clr - 28mm(6mm-6mm)											
	0.230	0.630	0.224					ARG90	0.025(#2)	CL	TP-D	T
	U-Factor 0.40			SHGC(>1) 0.14				VT(>1) 0.23		CR 56		
920	Outswing - 4 Horizontal TDLS: SN 5128 / Arg / Clr - 28mm(6mm-6mm)											
	0.230	0.630	0.224					ARG90	0.025(#2)	CL	TP-D	T
	U-Factor 0.40			SHGC(>1) 0.14				VT(>1) 0.23		CR 56		

TEST REPORT FOR NEON ENERGY USA INC.

Report No: K0461.02-301-45 R3

Date: 12/18/20

SECTION 6 (Continued)

SIMULATION RESULTS

TOTAL PRODUCT CALCULATIONS (Ultra Outswing and Inswing Door)												
Option Number	Pane Thickness 1 (in)	Gap Width 1 (in)	Pane Thickness 2 (in)	Gap Width 2 (in)	Pane Thickness 3 (in)	Gap Width 3 (in)	Pane Thickness 4 (in)	Gap Fill	Low-e (Surface #)	Tint	Spacer	Grid Type
	U-Factor (Btu/Hr-Ft2-F)			Solar Heat Gain Coefficient (SHGC) Grids (None / <1 / >=1)				Visible Transmittance (VT) Grids (None / <1 / >=1)		Condensation Resistance (CR)		
921	Outswing - 1 Vertical TDL: SN 5128 / Arg / Clr - 28mm(6mm-6mm)											
	0.230	0.630	0.224					ARG90	0.025(#2)	CL	TP-D	T
	U-Factor 0.39			SHGC(>1) 0.14				VT(>1) 0.23		CR 56		
922	Outswing - 2 Vertical TDLs: SN 5128 / Arg / Clr - 28mm(6mm-6mm)											
	0.230	0.630	0.224					ARG90	0.025(#2)	CL	TP-D	T
	U-Factor 0.41			SHGC(>1) 0.14				VT(>1) 0.23		CR 56		
923	Outswing - 3 Vertical TDLs: SN 5128 / Arg / Clr - 28mm(6mm-6mm)											
	0.230	0.630	0.224					ARG90	0.025(#2)	CL	TP-D	T
	U-Factor 0.43			SHGC(>1) 0.14				VT(>1) 0.23		CR 56		
924	Outswing - 4 Vertical TDLs: SN 5128 / Arg / Clr - 28mm(6mm-6mm)											
	0.230	0.630	0.224					ARG90	0.025(#2)	CL	TP-D	T
	U-Factor 0.48			SHGC(>1) 0.14				VT(>1) 0.23		CR 56		
925	Outswing: SN 7037 / Arg / Clr - 28mm(6mm-6mm)											
	0.230	0.630	0.224					ARG90	0.022(#2)	CL	TP-D	N
	U-Factor 0.37			SHGC(N) 0.23				VT(N) 0.44		CR 56		
926	Outswing - 1 Horizontal TDL: SN 7037 / Arg / Clr - 28mm(6mm-6mm)											
	0.230	0.630	0.224					ARG90	0.022(#2)	CL	TP-D	T
	U-Factor 0.38			SHGC(>1) 0.18				VT(>1) 0.32		CR 56		
927	Outswing - 2 Horizontal TDLs: SN 7037 / Arg / Clr - 28mm(6mm-6mm)											
	0.230	0.630	0.224					ARG90	0.022(#2)	CL	TP-D	T
	U-Factor 0.39			SHGC(>1) 0.18				VT(>1) 0.32		CR 56		
928	Outswing - 3 Horizontal TDLs: SN 7037 / Arg / Clr - 28mm(6mm-6mm)											
	0.230	0.630	0.224					ARG90	0.022(#2)	CL	TP-D	T
	U-Factor 0.40			SHGC(>1) 0.18				VT(>1) 0.32		CR 56		
929	Outswing - 4 Horizontal TDLs: SN 7037 / Arg / Clr - 28mm(6mm-6mm)											
	0.230	0.630	0.224					ARG90	0.022(#2)	CL	TP-D	T
	U-Factor 0.40			SHGC(>1) 0.18				VT(>1) 0.32		CR 56		
930	Outswing - 1 Vertical TDL: SN 7037 / Arg / Clr - 28mm(6mm-6mm)											
	0.230	0.630	0.224					ARG90	0.022(#2)	CL	TP-D	T
	U-Factor 0.39			SHGC(>1) 0.18				VT(>1) 0.32		CR 56		

TEST REPORT FOR NEON ENERGY USA INC.

Report No: K0461.02-301-45 R3

Date: 12/18/20

SECTION 6 (Continued)

SIMULATION RESULTS

TOTAL PRODUCT CALCULATIONS (Ultra Outswing and Inswing Door)												
Option Number	Pane Thickness 1 (in)	Gap Width 1 (in)	Pane Thickness 2 (in)	Gap Width 2 (in)	Pane Thickness 3 (in)	Gap Width 3 (in)	Pane Thickness 4 (in)	Gap Fill	Low-e (Surface #)	Tint	Spacer	Grid Type
	U-Factor (Btu/Hr-Ft2-F)			Solar Heat Gain Coefficient (SHGC) Grids (None / <1 / >=1)				Visible Transmittance (VT) Grids (None / <1 / >=1)		Condensation Resistance (CR)		
931	Outswing - 2 Vertical TDs: SN 7037 / Arg / Clr - 28mm(6mm-6mm)											
	0.230	0.630	0.224					ARG90	0.022(#2)	CL	TP-D	T
	U-Factor 0.41			SHGC(>1) 0.18				VT(>1) 0.32		CR 56		
932	Outswing - 3 Vertical TDs: SN 7037 / Arg / Clr - 28mm(6mm-6mm)											
	0.230	0.630	0.224					ARG90	0.022(#2)	CL	TP-D	T
	U-Factor 0.43			SHGC(>1) 0.18				VT(>1) 0.32		CR 56		
933	Outswing - 4 Vertical TDs: SN 7037 / Arg / Clr - 28mm(6mm-6mm)											
	0.230	0.630	0.224					ARG90	0.022(#2)	CL	TP-D	T
	U-Factor 0.48			SHGC(>1) 0.18				VT(>1) 0.32		CR 56		
934	Outswing w/ Kickplate: SN 7037 / Arg / IS20 - 28mm(6mm-6mm)											
	0.230	0.630	0.221					ARG90	0.022(#2) / 0.198(#4)	CL	TP-D	N
	U-Factor 0.38			SHGC(N) 0.21				VT(N) 0.39		CR 50		
935	Outswing w/ Kickplate - 1 Horizontal TDL: SN 7037 / Arg / IS20 - 28mm(6mm-6mm)											
	0.230	0.630	0.221					ARG90	0.022(#2) / 0.198(#4)	CL	TP-D	T
	U-Factor 0.39			SHGC(>1) 0.16				VT(>1) 0.28		CR 50		
936	Outswing w/ Kickplate - 2 Horizontal TDs: SN 7037 / Arg / IS20 - 28mm(6mm-6mm)											
	0.230	0.630	0.221					ARG90	0.022(#2) / 0.198(#4)	CL	TP-D	T
	U-Factor 0.39			SHGC(>1) 0.16				VT(>1) 0.28		CR 50		
937	Outswing w/ Kickplate - 3 Horizontal TDs: SN 7037 / Arg / IS20 - 28mm(6mm-6mm)											
	0.230	0.630	0.221					ARG90	0.022(#2) / 0.198(#4)	CL	TP-D	T
	U-Factor 0.40			SHGC(>1) 0.16				VT(>1) 0.28		CR 50		
938	Outswing w/ Kickplate - 4 Horizontal TDs: SN 7037 / Arg / IS20 - 28mm(6mm-6mm)											
	0.230	0.630	0.221					ARG90	0.022(#2) / 0.198(#4)	CL	TP-D	T
	U-Factor 0.41			SHGC(>1) 0.16				VT(>1) 0.28		CR 50		
939	Outswing w/ Kickplate - 1 Vertical TDL: SN 7037 / Arg / IS20 - 28mm(6mm-6mm)											
	0.230	0.630	0.221					ARG90	0.022(#2) / 0.198(#4)	CL	TP-D	T
	U-Factor 0.40			SHGC(>1) 0.16				VT(>1) 0.28		CR 50		
940	Outswing w/ Kickplate - 2 Vertical TDs: SN 7037 / Arg / IS20 - 28mm(6mm-6mm)											
	0.230	0.630	0.221					ARG90	0.022(#2) / 0.198(#4)	CL	TP-D	T
	U-Factor 0.42			SHGC(>1) 0.16				VT(>1) 0.28		CR 50		

TEST REPORT FOR NEON ENERGY USA INC.

Report No: K0461.02-301-45 R3

Date: 12/18/20

SECTION 6 (Continued)

SIMULATION RESULTS

TOTAL PRODUCT CALCULATIONS (Ultra Outswing and Inswing Door)												
Option Number	Pane Thickness 1 (in)	Gap Width 1 (in)	Pane Thickness 2 (in)	Gap Width 2 (in)	Pane Thickness 3 (in)	Gap Width 3 (in)	Pane Thickness 4 (in)	Gap Fill	Low-e (Surface #)	Tint	Spacer	Grid Type
	U-Factor (Btu/Hr-Ft ² -F)			Solar Heat Gain Coefficient (SHGC) Grids (None / <1 / >=1)				Visible Transmittance (VT) Grids (None / <1 / >=1)		Condensation Resistance (CR)		
941	Outswing w/ Kickplate - 3 Vertical TDs: SN 7037 / Arg / IS20 - 28mm(6mm-6mm)											
	0.230	0.630	0.221					ARG90	0.022(#2) / 0.198(#4)	CL	TP-D	T
	U-Factor 0.44			SHGC(>1) 0.16				VT(>1) 0.28		CR 50		
942	Outswing w/ Kickplate - 4 Vertical TDs: SN 7037 / Arg / IS20 - 28mm(6mm-6mm)											
	0.230	0.630	0.221					ARG90	0.022(#2) / 0.198(#4)	CL	TP-D	T
	U-Factor 0.48			SHGC(>1) 0.16				VT(>1) 0.28		CR 50		
943	Outswing w/ Kickplate: SN 5128 / Arg / Clr - 28mm(6mm-6mm)											
	0.230	0.630	0.224					ARG90	0.025(#2)	CL	TP-D	N
	U-Factor 0.41			SHGC(N) 0.16				VT(N) 0.29		CR 52		
944	Outswing w/ Kickplate - 1 Horizontal TDL: SN 5128 / Arg / Clr - 28mm(6mm-6mm)											
	0.230	0.630	0.224					ARG90	0.025(#2)	CL	TP-D	T
	U-Factor 0.41			SHGC(>1) 0.13				VT(>1) 0.21		CR 52		
945	Outswing w/ Kickplate - 2 Horizontal TDs: SN 5128 / Arg / Clr - 28mm(6mm-6mm)											
	0.230	0.630	0.224					ARG90	0.025(#2)	CL	TP-D	T
	U-Factor 0.42			SHGC(>1) 0.13				VT(>1) 0.21		CR 52		
946	Outswing w/ Kickplate - 3 Horizontal TDs: SN 5128 / Arg / Clr - 28mm(6mm-6mm)											
	0.230	0.630	0.224					ARG90	0.025(#2)	CL	TP-D	T
	U-Factor 0.43			SHGC(>1) 0.13				VT(>1) 0.21		CR 52		
947	Outswing w/ Kickplate - 4 Horizontal TDs: SN 5128 / Arg / Clr - 28mm(6mm-6mm)											
	0.230	0.630	0.224					ARG90	0.025(#2)	CL	TP-D	T
	U-Factor 0.43			SHGC(>1) 0.13				VT(>1) 0.21		CR 52		
948	Outswing w/ Kickplate - 1 Vertical TDL: SN 5128 / Arg / Clr - 28mm(6mm-6mm)											
	0.230	0.630	0.224					ARG90	0.025(#2)	CL	TP-D	T
	U-Factor 0.42			SHGC(>1) 0.13				VT(>1) 0.21		CR 52		
949	Outswing w/ Kickplate - 2 Vertical TDs: SN 5128 / Arg / Clr - 28mm(6mm-6mm)											
	0.230	0.630	0.224					ARG90	0.025(#2)	CL	TP-D	T
	U-Factor 0.44			SHGC(>1) 0.13				VT(>1) 0.21		CR 52		
950	Outswing w/ Kickplate - 3 Vertical TDs: SN 5128 / Arg / Clr - 28mm(6mm-6mm)											
	0.230	0.630	0.224					ARG90	0.025(#2)	CL	TP-D	T
	U-Factor 0.45			SHGC(>1) 0.13				VT(>1) 0.21		CR 52		

TEST REPORT FOR NEON ENERGY USA INC.

Report No: K0461.02-301-45 R3

Date: 12/18/20

SECTION 6 (Continued)

SIMULATION RESULTS

TOTAL PRODUCT CALCULATIONS (Ultra Outswing and Inswing Door)												
Option Number	Pane Thickness 1 (in)	Gap Width 1 (in)	Pane Thickness 2 (in)	Gap Width 2 (in)	Pane Thickness 3 (in)	Gap Width 3 (in)	Pane Thickness 4 (in)	Gap Fill	Low-e (Surface #)	Tint	Spacer	Grid Type
	U-Factor (Btu/Hr-Ft2-F)			Solar Heat Gain Coefficient (SHGC) Grids (None / <1 / >=1)				Visible Transmittance (VT) Grids (None / <1 / >=1)		Condensation Resistance (CR)		
951	Outswing w/ Kickplate - 4 Vertical TDs: SN 5128 / Arg / Clr - 28mm(6mm-6mm)											
	0.230	0.630	0.224					ARG90	0.025(#2)	CL	TP-D	T
	U-Factor 0.50			SHGC(>1) 0.13				VT(>1) 0.21		CR 52		
952	Outswing w/ Kickplate: SN 7037 / Arg / Clr - 28mm(6mm-6mm)											
	0.230	0.630	0.224					ARG90	0.022(#2)	CL	TP-D	N
	U-Factor 0.41			SHGC(N) 0.21				VT(N) 0.40		CR 52		
953	Outswing w/ Kickplate - 1 Horizontal TDL: SN 7037 / Arg / Clr - 28mm(6mm-6mm)											
	0.230	0.630	0.224					ARG90	0.022(#2)	CL	TP-D	T
	U-Factor 0.41			SHGC(>1) 0.16				VT(>1) 0.29		CR 52		
954	Outswing w/ Kickplate - 2 Horizontal TDs: SN 7037 / Arg / Clr - 28mm(6mm-6mm)											
	0.230	0.630	0.224					ARG90	0.022(#2)	CL	TP-D	T
	U-Factor 0.42			SHGC(>1) 0.16				VT(>1) 0.29		CR 52		
955	Outswing w/ Kickplate - 3 Horizontal TDs: SN 7037 / Arg / Clr - 28mm(6mm-6mm)											
	0.230	0.630	0.224					ARG90	0.022(#2)	CL	TP-D	T
	U-Factor 0.43			SHGC(>1) 0.16				VT(>1) 0.29		CR 52		
956	Outswing w/ Kickplate - 4 Horizontal TDs: SN 7037 / Arg / Clr - 28mm(6mm-6mm)											
	0.230	0.630	0.224					ARG90	0.022(#2)	CL	TP-D	T
	U-Factor 0.43			SHGC(>1) 0.16				VT(>1) 0.29		CR 52		
957	Outswing w/ Kickplate - 1 Vertical TDL: SN 7037 / Arg / Clr - 28mm(6mm-6mm)											
	0.230	0.630	0.224					ARG90	0.022(#2)	CL	TP-D	T
	U-Factor 0.42			SHGC(>1) 0.16				VT(>1) 0.29		CR 52		
958	Outswing w/ Kickplate - 2 Vertical TDs: SN 7037 / Arg / Clr - 28mm(6mm-6mm)											
	0.230	0.630	0.224					ARG90	0.022(#2)	CL	TP-D	T
	U-Factor 0.44			SHGC(>1) 0.16				VT(>1) 0.29		CR 52		
959	Outswing w/ Kickplate - 3 Vertical TDs: SN 7037 / Arg / Clr - 28mm(6mm-6mm)											
	0.230	0.630	0.224					ARG90	0.022(#2)	CL	TP-D	T
	U-Factor 0.45			SHGC(>1) 0.16				VT(>1) 0.29		CR 52		
960	Outswing w/ Kickplate - 4 Vertical TDs: SN 7037 / Arg / Clr - 28mm(6mm-6mm)											
	0.230	0.630	0.224					ARG90	0.022(#2)	CL	TP-D	T
	U-Factor 0.50			SHGC(>1) 0.16				VT(>1) 0.29		CR 52		

TEST REPORT FOR NEON ENERGY USA INC.

Report No: K0461.02-301-45 R3

Date: 12/18/20

SECTION 6 (Continued)

SIMULATION RESULTS

TOTAL PRODUCT CALCULATIONS (Ultra Outswing and Inswing Door)												
Option Number	Pane Thickness 1 (in)	Gap Width 1 (in)	Pane Thickness 2 (in)	Gap Width 2 (in)	Pane Thickness 3 (in)	Gap Width 3 (in)	Pane Thickness 4 (in)	Gap Fill	Low-e (Surface #)	Tint	Spacer	Grid Type
	U-Factor (Btu/Hr-Ft2-F)			Solar Heat Gain Coefficient (SHGC) Grids (None / <1 / >=1)				Visible Transmittance (VT) Grids (None / <1 / >=1)		Condensation Resistance (CR)		
961	Inswing: SN 7037 / Arg / CGDry ExtraClr - 28mm(6mm-6mm)											
	0.230	0.630	0.230					ARG90	0.022(#2) / 0.200(#4)	CL	TS-D	N
	U-Factor 0.33			SHGC (N) 0.24				VT (N) 0.48		CR 50		
962	Inswing - NFRC Default: SN 7037 / Arg / CGDry ExtraClr - 28mm(6mm-6mm)											
	0.230	0.630	0.230					ARG90	0.022(#2) / 0.200(#4)	CL	TS-D	N
	U-Factor 0.45			SHGC (N) 0.24				VT (N) 0.48		CR 50		
963	Inswing - 1 Horizontal TDL: SN 7037 / Arg / CGDry ExtraClr - 28mm(6mm-6mm)											
	0.230	0.630	0.230					ARG90	0.022(#2) / 0.200(#4)	CL	TS-D	N
	U-Factor 0.34			SHGC (N) 0.24				VT (N) 0.48		CR 50		
964	Inswing - 2 Horizontal TDLs: SN 7037 / Arg / CGDry ExtraClr - 28mm(6mm-6mm)											
	0.230	0.630	0.230					ARG90	0.022(#2) / 0.200(#4)	CL	TS-D	N
	U-Factor 0.35			SHGC (N) 0.24				VT (N) 0.48		CR 50		
965	Inswing - 3 Horizontal TDLs: SN 7037 / Arg / CGDry ExtraClr - 28mm(6mm-6mm)											
	0.230	0.630	0.230					ARG90	0.022(#2) / 0.200(#4)	CL	TS-D	N
	U-Factor 0.36			SHGC (N) 0.24				VT (N) 0.48		CR 50		
966	Inswing - 4 Horizontal TDLs: SN 7037 / Arg / CGDry ExtraClr - 28mm(6mm-6mm)											
	0.230	0.630	0.230					ARG90	0.022(#2) / 0.200(#4)	CL	TS-D	N
	U-Factor 0.37			SHGC (N) 0.24				VT (N) 0.48		CR 50		
967	Inswing - 1 Vertical TDL: SN 7037 / Arg / CGDry ExtraClr - 28mm(6mm-6mm)											
	0.230	0.630	0.230					ARG90	0.022(#2) / 0.200(#4)	CL	TS-D	N
	U-Factor 0.36			SHGC (N) 0.24				VT (N) 0.48		CR 50		
968	Inswing - 2 Vertical TDLs: SN 7037 / Arg / CGDry ExtraClr - 28mm(6mm-6mm)											
	0.230	0.630	0.230					ARG90	0.022(#2) / 0.200(#4)	CL	TS-D	N
	U-Factor 0.38			SHGC (N) 0.24				VT (N) 0.48		CR 50		
969	Inswing - 3 Vertical TDLs: SN 7037 / Arg / CGDry ExtraClr - 28mm(6mm-6mm)											
	0.230	0.630	0.230					ARG90	0.022(#2) / 0.200(#4)	CL	TS-D	N
	U-Factor 0.41			SHGC (N) 0.24				VT (N) 0.48		CR 50		
970	Inswing - 4 Vertical TDLs: SN 7037 / Arg / CGDry ExtraClr - 28mm(6mm-6mm)											
	0.230	0.630	0.230					ARG90	0.022(#2) / 0.200(#4)	CL	TS-D	N
	U-Factor 0.46			SHGC (N) 0.24				VT (N) 0.48		CR 50		

TEST REPORT FOR NEON ENERGY USA INC.

Report No: K0461.02-301-45 R3

Date: 12/18/20

SECTION 6 (Continued) SIMULATION RESULTS

TOTAL PRODUCT CALCULATIONS (Ultra Outswing and Inswing Door)												
Option Number	Pane Thickness 1 (in)	Gap Width 1 (in)	Pane Thickness 2 (in)	Gap Width 2 (in)	Pane Thickness 3 (in)	Gap Width 3 (in)	Pane Thickness 4 (in)	Gap Fill	Low-e (Surface #)	Tint	Spacer	Grid Type
	U-Factor (Btu/Hr-Ft2-F)			Solar Heat Gain Coefficient (SHGC) Grids (None / <1 / >=1)				Visible Transmittance (VT) Grids (None / <1 / >=1)		Condensation Resistance (CR)		
971	Inswing w/ Kickplate: SN 7037 / Arg / CGDry ExtraClr - 28mm(6mm-6mm)											
	0.230	0.630	0.230					ARG90	0.022(#2) / 0.200(#4)	CL	TS-D	N
	U-Factor 0.36			SHGC (N) 0.23				VT (N) 0.43		CR 48		
972	Inswing w/ Kickplate - NFRC Default: SN 7037 / Arg / CGDry ExtraClr - 28mm(6mm-6mm)											
	0.230	0.630	0.230					ARG90	0.022(#2) / 0.200(#4)	CL	TS-D	N
	U-Factor 0.48			SHGC (N) 0.23				VT (N) 0.43		CR 48		
973	Inswing w/ Kickplate - 1 Horizontal TDL: SN 7037 / Arg / CGDry ExtraClr - 28mm(6mm-6mm)											
	0.230	0.630	0.230					ARG90	0.022(#2) / 0.200(#4)	CL	TS-D	N
	U-Factor 0.37			SHGC (N) 0.23				VT (N) 0.43		CR 48		
974	Inswing w/ Kickplate - 2 Horizontal TDLs: SN 7037 / Arg / CGDry ExtraClr - 28mm(6mm-6mm)											
	0.230	0.630	0.230					ARG90	0.022(#2) / 0.200(#4)	CL	TS-D	N
	U-Factor 0.38			SHGC (N) 0.23				VT (N) 0.43		CR 48		
975	Inswing w/ Kickplate - 3 Horizontal TDLs: SN 7037 / Arg / CGDry ExtraClr - 28mm(6mm-6mm)											
	0.230	0.630	0.230					ARG90	0.022(#2) / 0.200(#4)	CL	TS-D	N
	U-Factor 0.39			SHGC (N) 0.23				VT (N) 0.43		CR 48		
976	Inswing w/ Kickplate - 4 Horizontal TDLs: SN 7037 / Arg / CGDry ExtraClr - 28mm(6mm-6mm)											
	0.230	0.630	0.230					ARG90	0.022(#2) / 0.200(#4)	CL	TS-D	N
	U-Factor 0.40			SHGC (N) 0.23				VT (N) 0.43		CR 48		
977	Inswing w/ Kickplate - 1 Vertical TDL: SN 7037 / Arg / CGDry ExtraClr - 28mm(6mm-6mm)											
	0.230	0.630	0.230					ARG90	0.022(#2) / 0.200(#4)	CL	TS-D	N
	U-Factor 0.39			SHGC (N) 0.23				VT (N) 0.43		CR 48		
978	Inswing w/ Kickplate - 2 Vertical TDLs: SN 7037 / Arg / CGDry ExtraClr - 28mm(6mm-6mm)											
	0.230	0.630	0.230					ARG90	0.022(#2) / 0.200(#4)	CL	TS-D	N
	U-Factor 0.41			SHGC (N) 0.23				VT (N) 0.43		CR 48		
979	Inswing w/ Kickplate - 3 Vertical TDLs: SN 7037 / Arg / CGDry ExtraClr - 28mm(6mm-6mm)											
	0.230	0.630	0.230					ARG90	0.022(#2) / 0.200(#4)	CL	TS-D	N
	U-Factor 0.44			SHGC (N) 0.23				VT (N) 0.43		CR 48		
980	Inswing w/ Kickplate - 4 Vertical TDLs: SN 7037 / Arg / CGDry ExtraClr - 28mm(6mm-6mm)											
	0.230	0.630	0.230					ARG90	0.022(#2) / 0.200(#4)	CL	TS-D	N
	U-Factor 0.48			SHGC (N) 0.23				VT (N) 0.43		CR 48		

TEST REPORT FOR NEON ENERGY USA INC.

Report No: K0461.02-301-45 R3

Date: 12/18/20

SECTION 6 (Continued)

SIMULATION RESULTS

TOTAL PRODUCT CALCULATIONS (Ultra Outswing and Inswing Door)												
Option Number	Pane Thickness 1 (in)	Gap Width 1 (in)	Pane Thickness 2 (in)	Gap Width 2 (in)	Pane Thickness 3 (in)	Gap Width 3 (in)	Pane Thickness 4 (in)	Gap Fill	Low-e (Surface #)	Tint	Spacer	Grid Type
	U-Factor (Btu/Hr-Ft ² -F)			Solar Heat Gain Coefficient (SHGC) Grids (None / <1 / >=1)				Visible Transmittance (VT) Grids (None / <1 / >=1)		Condensation Resistance (CR)		
981	Outswing: SN 7037 / Arg / CGDry ExtraClr - 28mm(6mm-6mm)											
	0.230	0.630	0.230					ARG90	0.022(#2) / 0.200(#4)	CL	TS-D	N
	U-Factor 0.35			SHGC (N) 0.22				VT (N) 0.43		CR 50		
982	Outswing - NFRC Default: SN 7037 / Arg / CGDry ExtraClr - 28mm(6mm-6mm)											
	0.230	0.630	0.230					ARG90	0.022(#2) / 0.200(#4)	CL	TS-D	N
	U-Factor 0.47			SHGC (N) 0.22				VT (N) 0.43		CR 50		
983	Outswing - 1 Horizontal TD: SN 7037 / Arg / CGDry ExtraClr - 28mm(6mm-6mm)											
	0.230	0.630	0.230					ARG90	0.022(#2) / 0.200(#4)	CL	TS-D	N
	U-Factor 0.36			SHGC (N) 0.22				VT (N) 0.43		CR 50		
984	Outswing - 2 Horizontal TDs: SN 7037 / Arg / CGDry ExtraClr - 28mm(6mm-6mm)											
	0.230	0.630	0.230					ARG90	0.022(#2) / 0.200(#4)	CL	TS-D	N
	U-Factor 0.37			SHGC (N) 0.22				VT (N) 0.43		CR 50		
985	Outswing - 3 Horizontal TDs: SN 7037 / Arg / CGDry ExtraClr - 28mm(6mm-6mm)											
	0.230	0.630	0.230					ARG90	0.022(#2) / 0.200(#4)	CL	TS-D	N
	U-Factor 0.38			SHGC (N) 0.22				VT (N) 0.43		CR 50		
986	Outswing - 4 Horizontal TDs: SN 7037 / Arg / CGDry ExtraClr - 28mm(6mm-6mm)											
	0.230	0.630	0.230					ARG90	0.022(#2) / 0.200(#4)	CL	TS-D	N
	U-Factor 0.39			SHGC (N) 0.22				VT (N) 0.43		CR 50		
987	Outswing - 1 Vertical TD: SN 7037 / Arg / CGDry ExtraClr - 28mm(6mm-6mm)											
	0.230	0.630	0.230					ARG90	0.022(#2) / 0.200(#4)	CL	TS-D	N
	U-Factor 0.38			SHGC (N) 0.22				VT (N) 0.43		CR 50		
988	Outswing - 2 Vertical TDs: SN 7037 / Arg / CGDry ExtraClr - 28mm(6mm-6mm)											
	0.230	0.630	0.230					ARG90	0.022(#2) / 0.200(#4)	CL	TS-D	N
	U-Factor 0.40			SHGC (N) 0.22				VT (N) 0.43		CR 50		
989	Outswing - 3 Vertical TDs: SN 7037 / Arg / CGDry ExtraClr - 28mm(6mm-6mm)											
	0.230	0.630	0.230					ARG90	0.022(#2) / 0.200(#4)	CL	TS-D	N
	U-Factor 0.43			SHGC (N) 0.22				VT (N) 0.43		CR 50		
990	Outswing - 4 Vertical TDs: SN 7037 / Arg / CGDry ExtraClr - 28mm(6mm-6mm)											
	0.230	0.630	0.230					ARG90	0.022(#2) / 0.200(#4)	CL	TS-D	N
	U-Factor 0.48			SHGC (N) 0.22				VT (N) 0.43		CR 50		

TEST REPORT FOR NEON ENERGY USA INC.

Report No: K0461.02-301-45 R3

Date: 12/18/20

SECTION 6 (Continued)

SIMULATION RESULTS

TOTAL PRODUCT CALCULATIONS (Ultra Outswing and Inswing Door)												
Option Number	Pane Thickness 1 (in)	Gap Width 1 (in)	Pane Thickness 2 (in)	Gap Width 2 (in)	Pane Thickness 3 (in)	Gap Width 3 (in)	Pane Thickness 4 (in)	Gap Fill	Low-e (Surface #)	Tint	Spacer	Grid Type
	U-Factor (Btu/Hr-Ft2-F)			Solar Heat Gain Coefficient (SHGC) Grids (None / <1 / >=1)				Visible Transmittance (VT) Grids (None / <1 / >=1)		Condensation Resistance (CR)		
991	Outswing w/ Kickplate: SN 7037 / Arg / CGDry ExtraClr - 28mm(6mm-6mm)											
	0.230	0.630	0.230					ARG90	0.022(#2) / 0.200(#4)	CL	TS-D	N
	U-Factor 0.38			SHGC (N) 0.21				VT (N) 0.39		CR 50		
992	Outswing w/ Kickplate - NFRC Default: SN 7037 / Arg / CGDry ExtraClr - 28mm(6mm-6mm)											
	0.230	0.630	0.230					ARG90	0.022(#2) / 0.200(#4)	CL	TS-D	N
	U-Factor 0.50			SHGC (N) 0.21				VT (N) 0.39		CR 50		
993	Outswing w/ Kickplate - 1 Horizontal TD: SN 7037 / Arg / CGDry ExtraClr - 28mm(6mm-6mm)											
	0.230	0.630	0.230					ARG90	0.022(#2) / 0.200(#4)	CL	TS-D	N
	U-Factor 0.39			SHGC (N) 0.21				VT (N) 0.39		CR 50		
994	Outswing w/ Kickplate - 2 Horizontal TDs: SN 7037 / Arg / CGDry ExtraClr - 28mm(6mm-6mm)											
	0.230	0.630	0.230					ARG90	0.022(#2) / 0.200(#4)	CL	TS-D	N
	U-Factor 0.40			SHGC (N) 0.21				VT (N) 0.39		CR 50		
995	Outswing w/ Kickplate - 3 Horizontal TDs: SN 7037 / Arg / CGDry ExtraClr - 28mm(6mm-6mm)											
	0.230	0.630	0.230					ARG90	0.022(#2) / 0.200(#4)	CL	TS-D	N
	U-Factor 0.41			SHGC (N) 0.21				VT (N) 0.39		CR 50		
996	Outswing w/ Kickplate - 4 Horizontal TDs: SN 7037 / Arg / CGDry ExtraClr - 28mm(6mm-6mm)											
	0.230	0.630	0.230					ARG90	0.022(#2) / 0.200(#4)	CL	TS-D	N
	U-Factor 0.42			SHGC (N) 0.21				VT (N) 0.39		CR 50		
997	Outswing w/ Kickplate - 1 Vertical TD: SN 7037 / Arg / CGDry ExtraClr - 28mm(6mm-6mm)											
	0.230	0.630	0.230					ARG90	0.022(#2) / 0.200(#4)	CL	TS-D	N
	U-Factor 0.41			SHGC (N) 0.21				VT (N) 0.39		CR 50		
998	Outswing w/ Kickplate - 2 Vertical TDs: SN 7037 / Arg / CGDry ExtraClr - 28mm(6mm-6mm)											
	0.230	0.630	0.230					ARG90	0.022(#2) / 0.200(#4)	CL	TS-D	N
	U-Factor 0.43			SHGC (N) 0.21				VT (N) 0.39		CR 50		
999	Outswing w/ Kickplate - 3 Vertical TDs: SN 7037 / Arg / CGDry ExtraClr - 28mm(6mm-6mm)											
	0.230	0.630	0.230					ARG90	0.022(#2) / 0.200(#4)	CL	TS-D	N
	U-Factor 0.45			SHGC (N) 0.21				VT (N) 0.39		CR 50		
1000	Outswing w/ Kickplate - 4 Vertical TDs: SN 7037 / Arg / CGDry ExtraClr - 28mm(6mm-6mm)											
	0.230	0.630	0.230					ARG90	0.022(#2) / 0.200(#4)	CL	TS-D	N
	U-Factor 0.50			SHGC (N) 0.21				VT (N) 0.39		CR 50		



Total Quality. Assured.

2524 E. Jensen Ave
Fresno, CA 93706

Telephone: 559-233-8705
Facsimile: 717-764-4129
www.intertek.com/building

TEST REPORT FOR NEON ENERGY USA INC.

Report No: K0461.02-301-45 R3

Date: 12/18/20

SECTION 7

DRAWINGS / BILL OF MATERIALS

The drawings which follow have been reviewed by Intertek B&C and are representative of the simulation results reported herein. Any deviations are documented herein or on the drawings.

Company Name: NEON ENERGY USA INC.

Series/Model: Cornell/Tramonto Inswing and Outswing Doors

Part #	Part Description	Material	Finish
Part #1	-	Aluminum	Painted
Part #2	-	Aluminum	Painted
Part #3	-	Polyamide	-
Part #4	-	Polyamide	-
Part #5	-	Polyamide	-
Part #6	-	Aluminum	Painted
Part #7	-	Aluminum	Painted
Part #8	-	Aluminum	Painted
Part #9	-	Aluminum	Painted
Part #10	-	EPDM	-
Part #11	-	EPDM	-
Part #12	-	Aluminum	Painted
Part #13	-	EPDM	-
Part #14	-	EPDM	-
Part #15	-	Vinyl	-
Part #16	-	EPDM	-
Part #17	-	Aluminum	Painted
Part #18	-	Aluminum	Painted
Part #19	-	Aluminum	Painted
Part #20	-	Aluminum	Painted
Part #21	-	Polyamide	-
Part #22	-	Polyamide	-
Part #23	-	Aluminum	Painted
Part #24	-	Aluminum	Painted
Part #25	-	Aluminum	Painted
Part #26	-	Aluminum	Painted

Ultra Inswing Door with Low Threshold

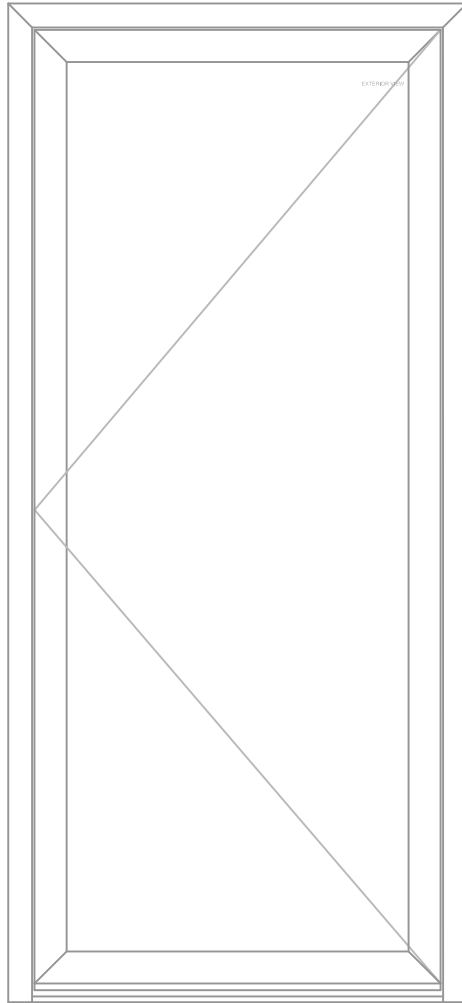

TVO-921



TVO-922



TVO-923

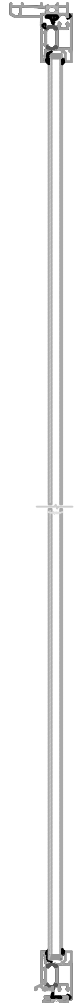

TVO-921

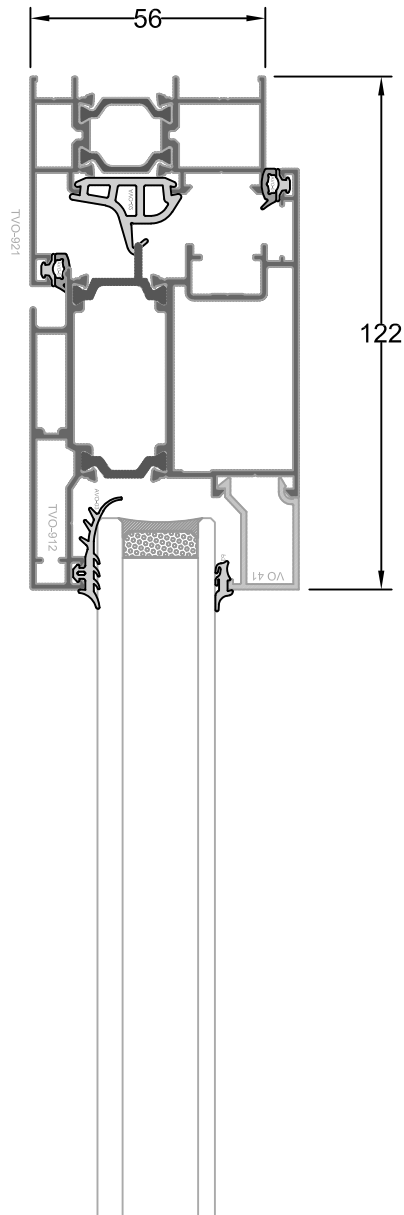

TVO-922

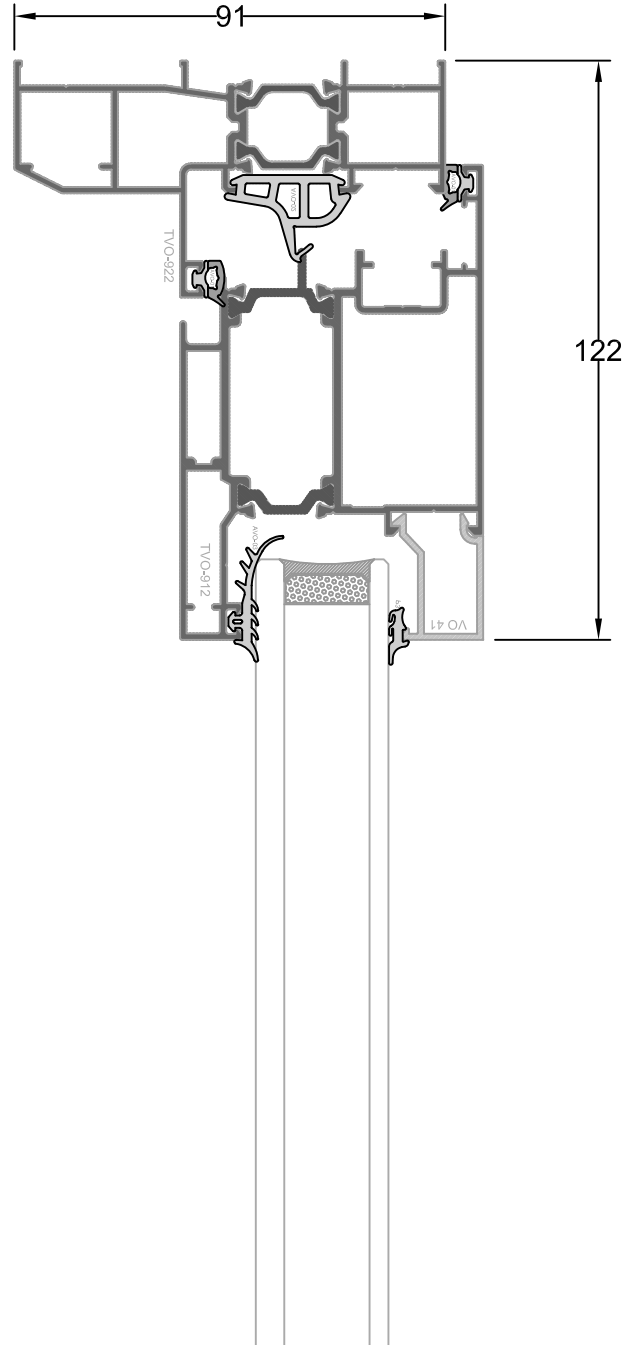

TVO-923

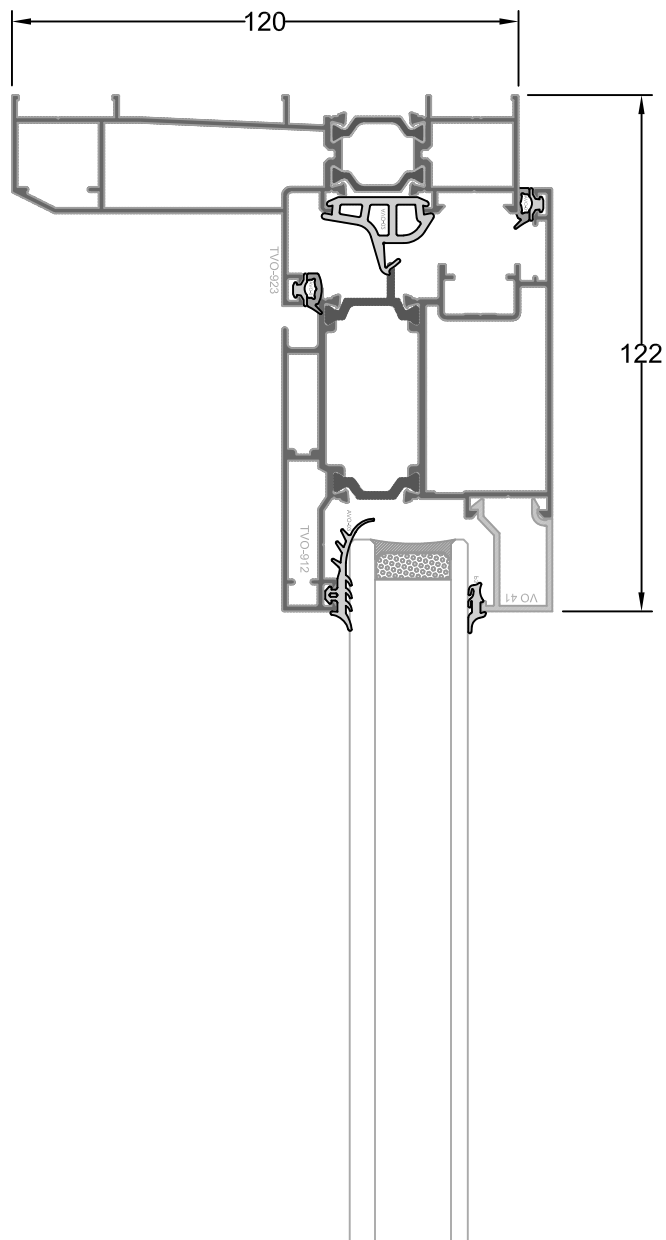

TVO-921

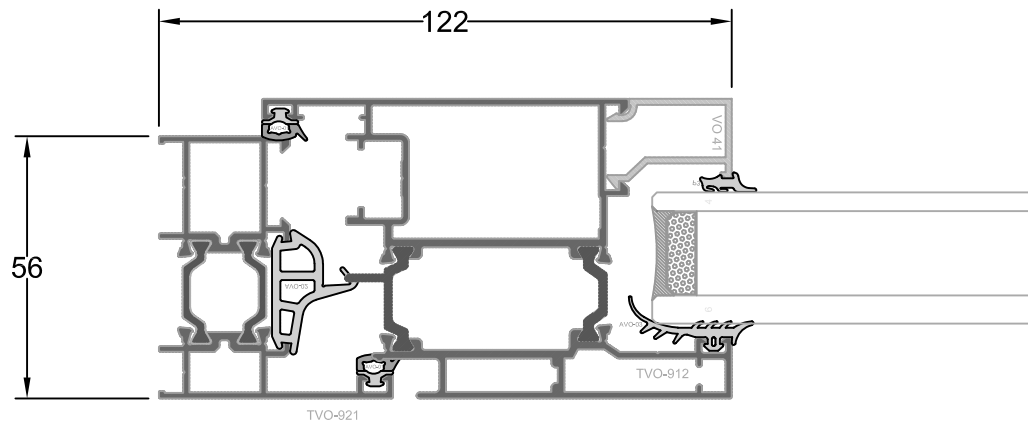

TVO-922

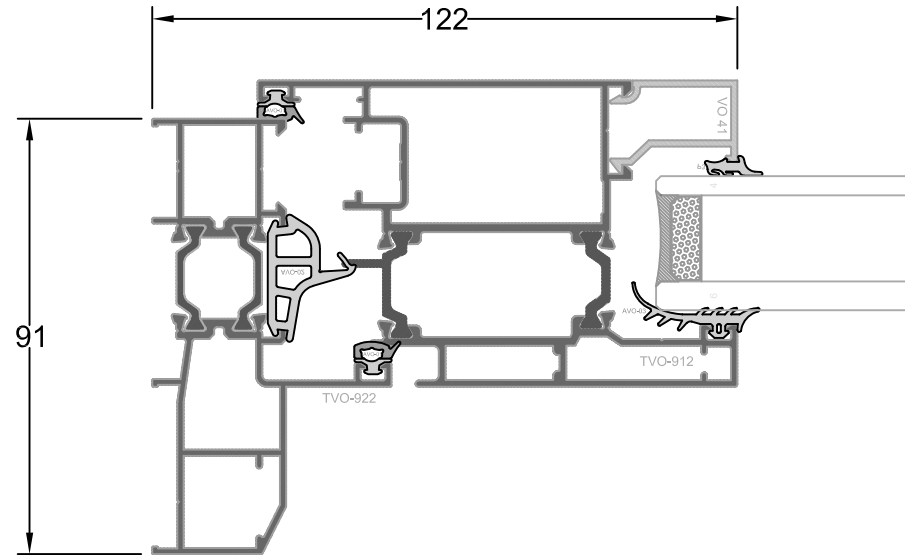

TVO-923

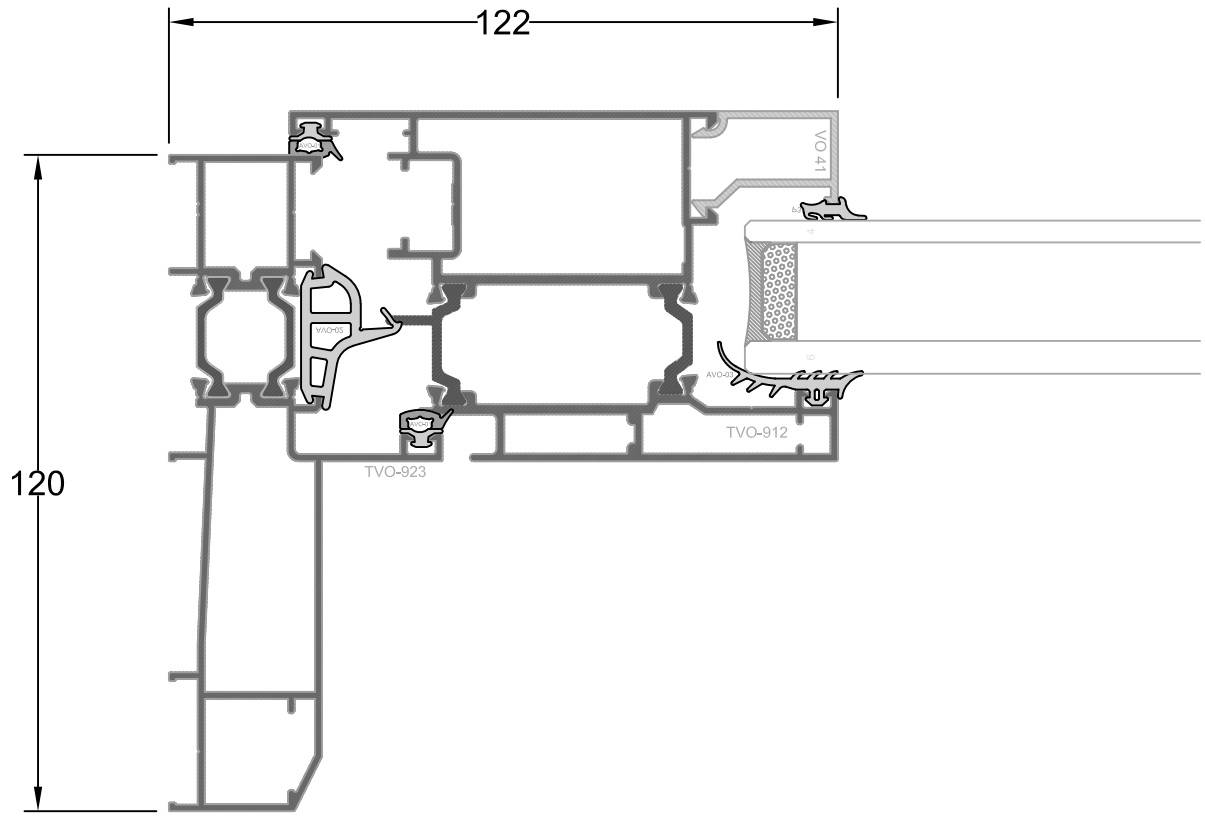

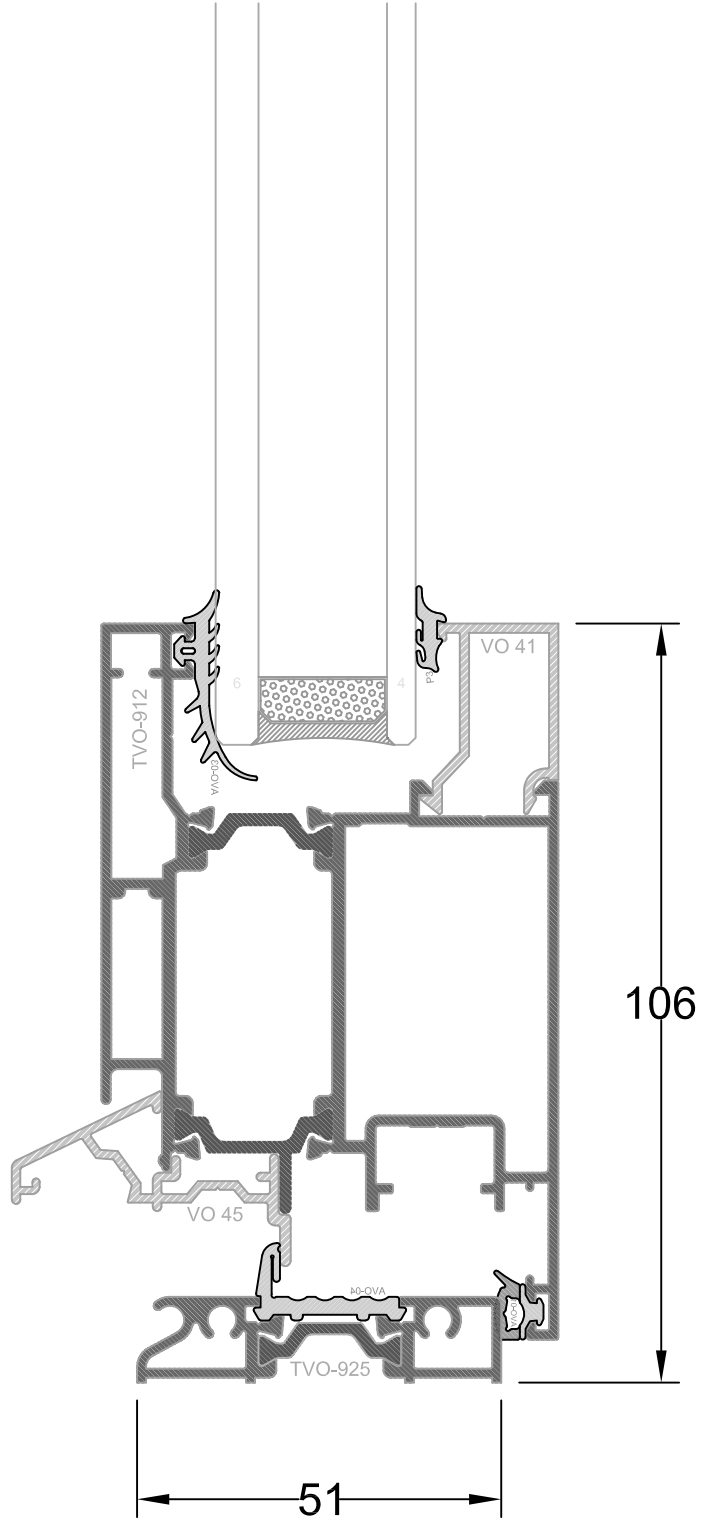

Ultra Inswing Door with Kickplate

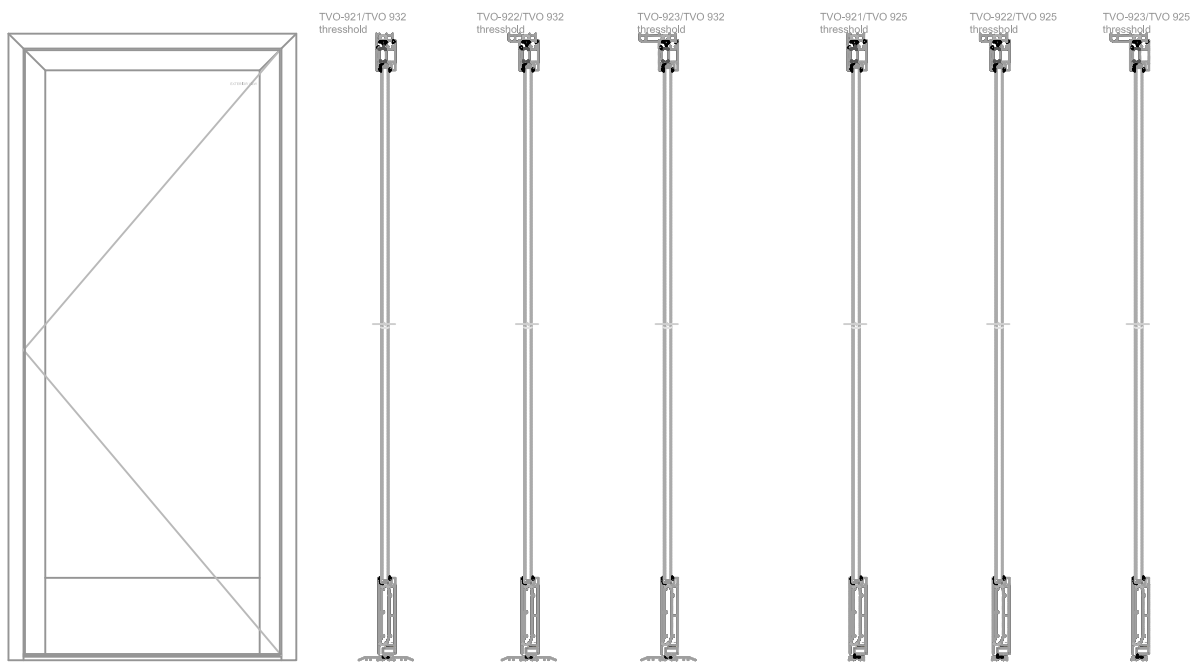

TVO-921

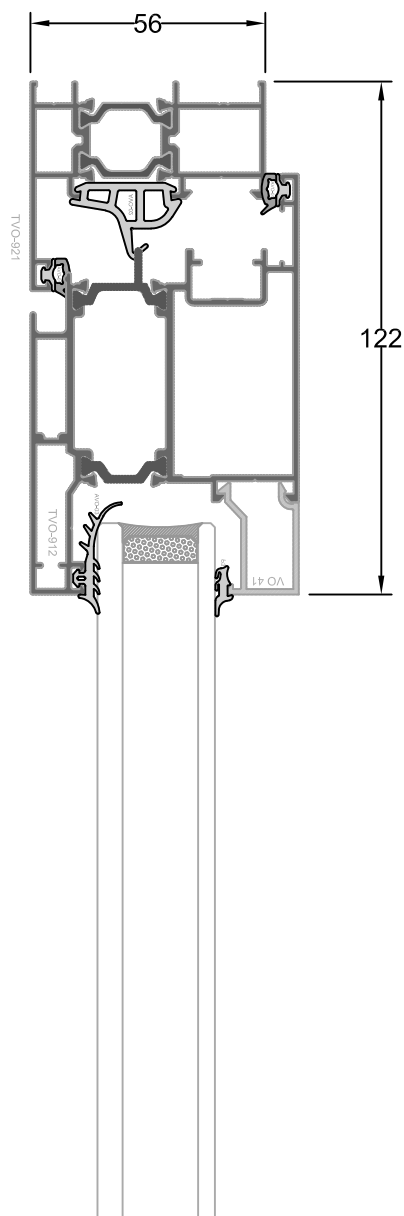

TVO-922

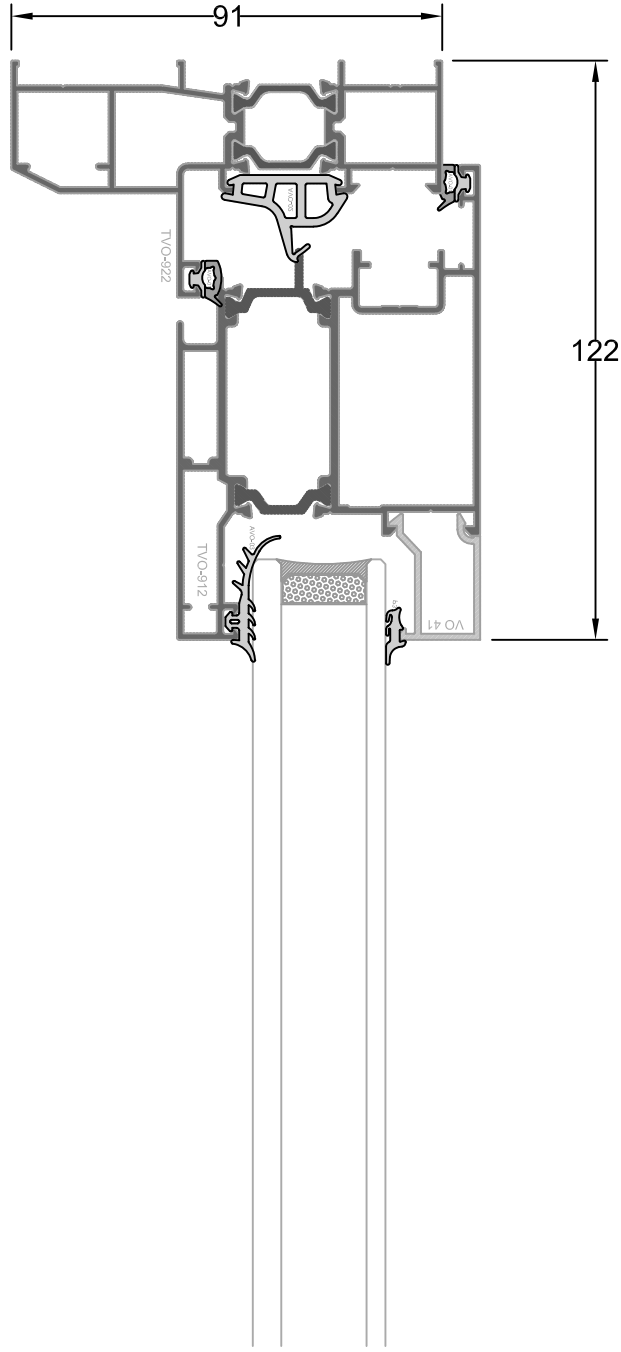

TVO-923

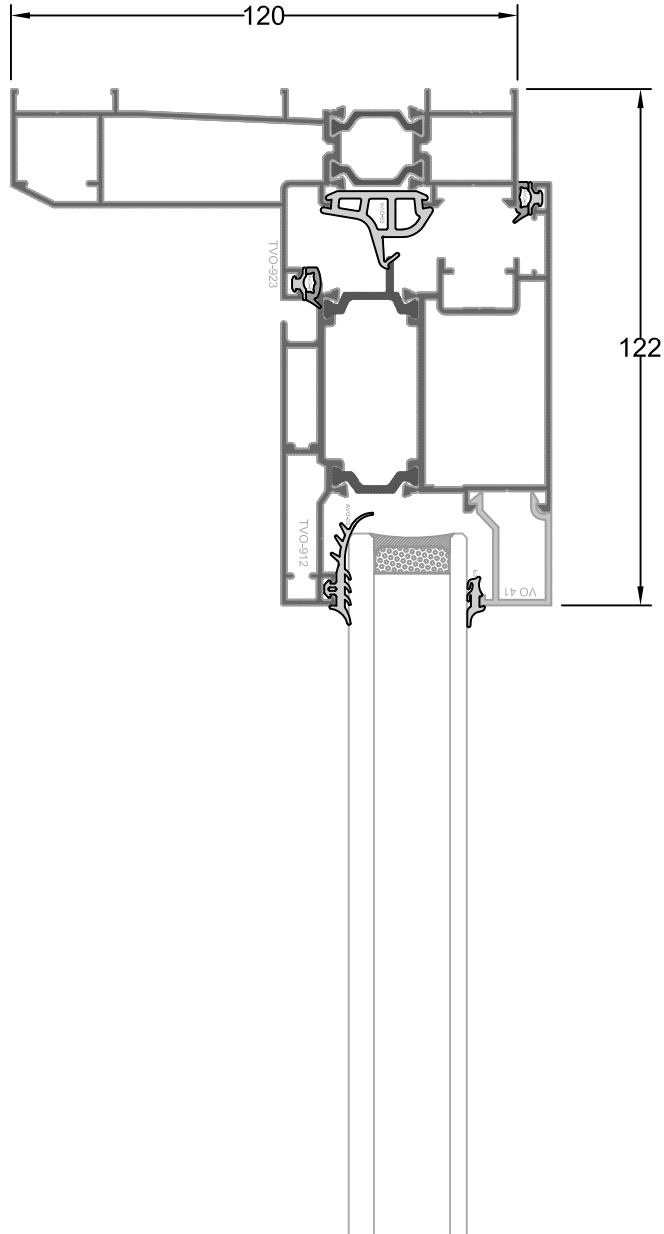

TVO-921

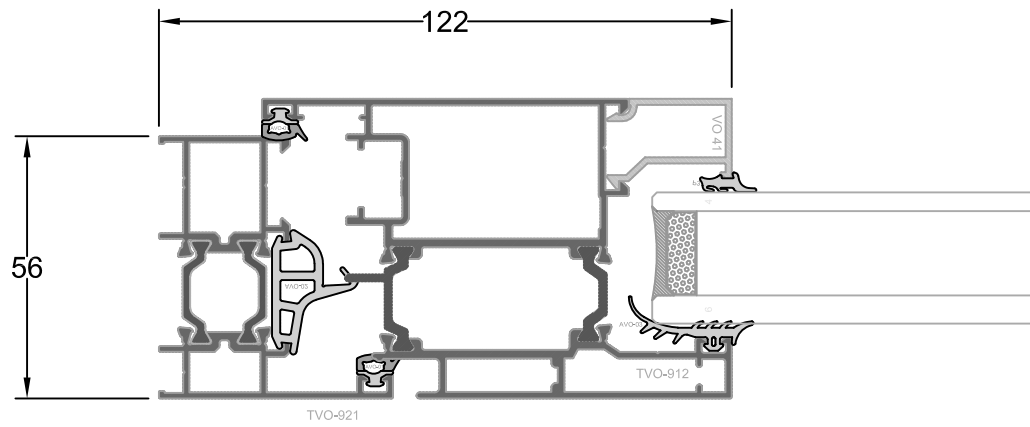

TVO-922

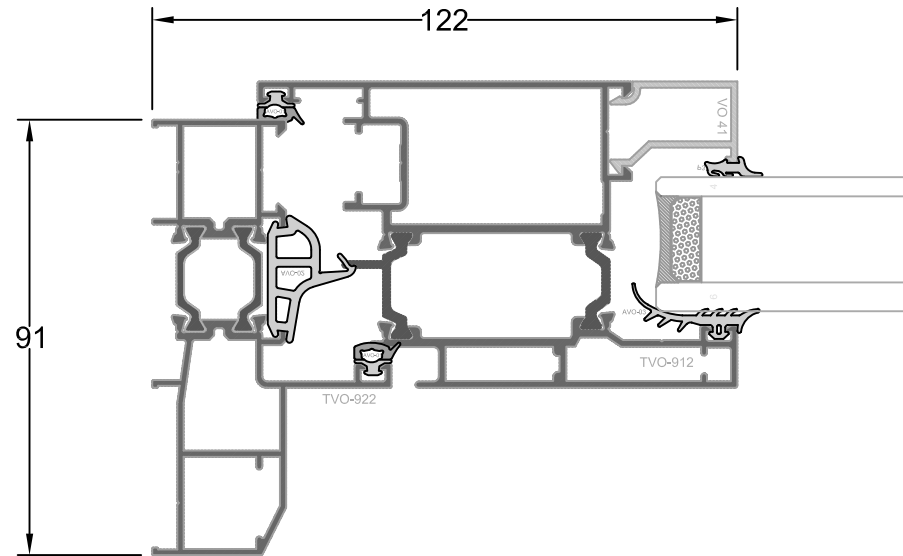

TVO-923

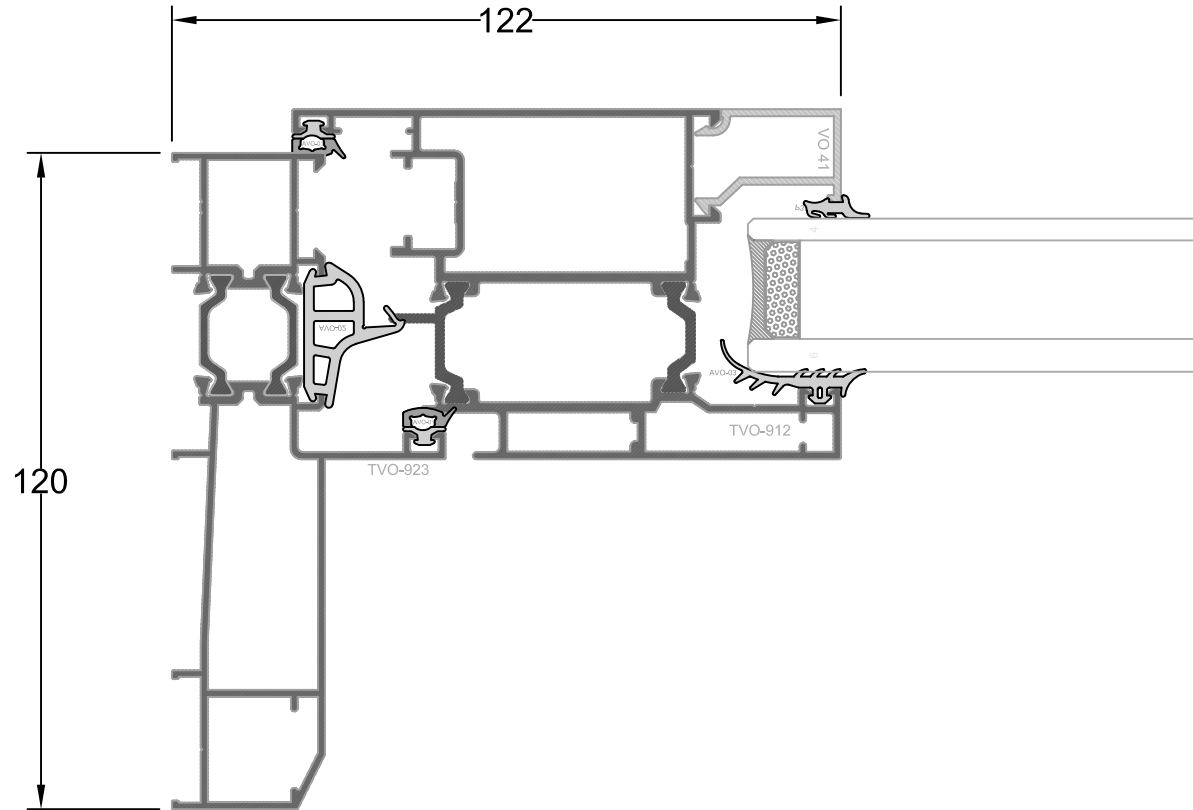

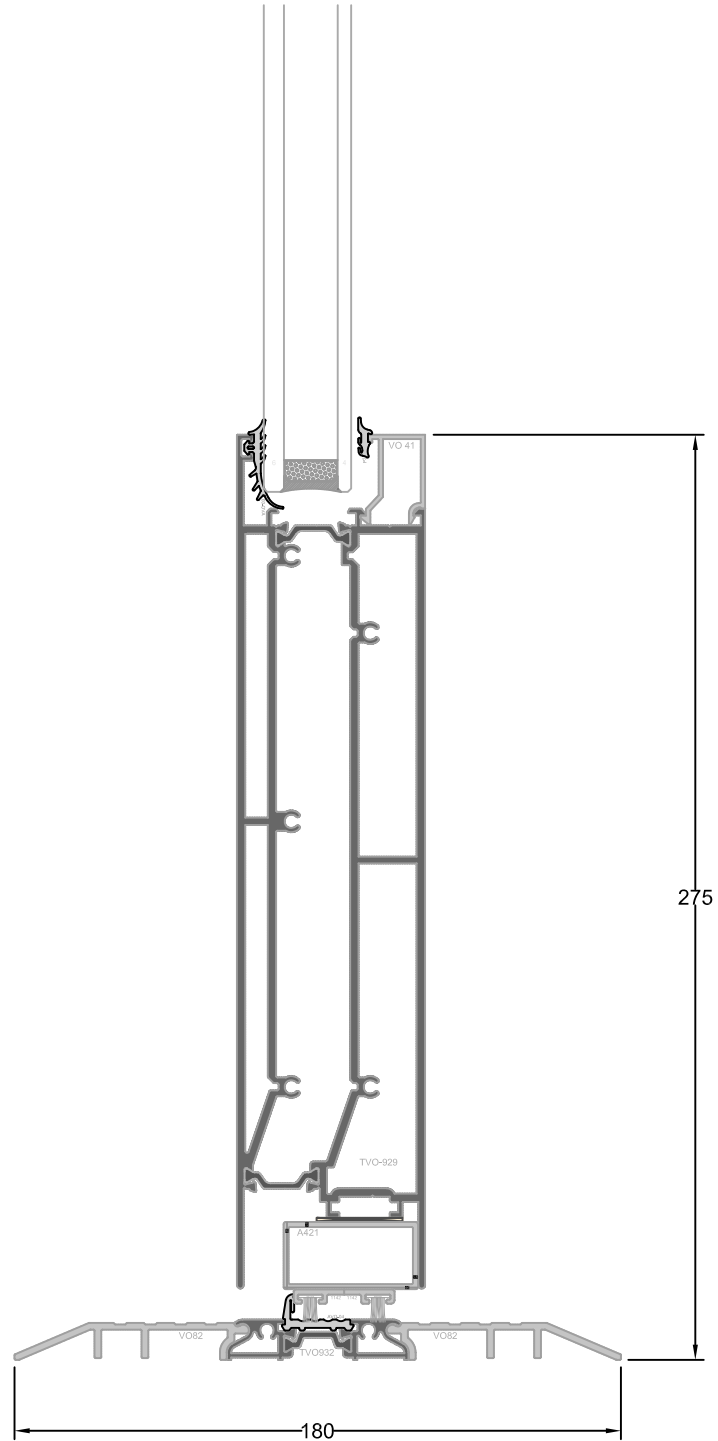

TVO 932 threshold

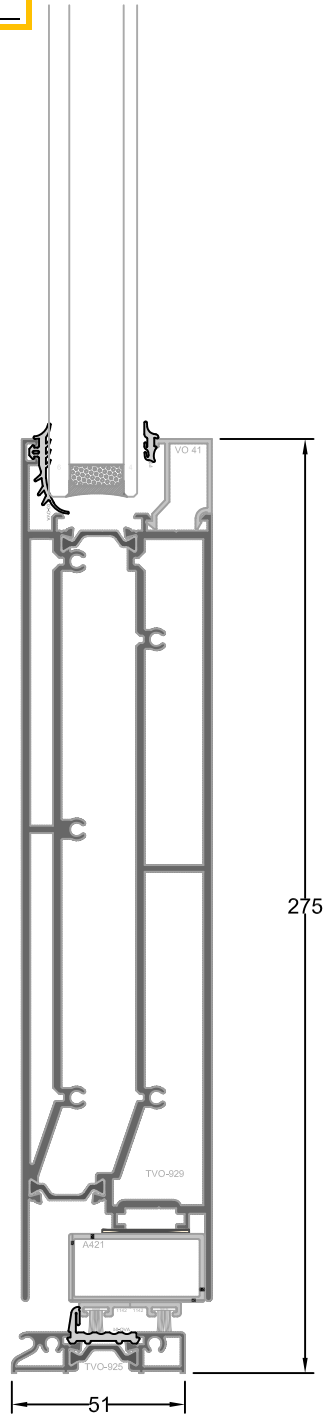

TVO 925 thresshold

Ultra Outswing Door with Low Threshshold

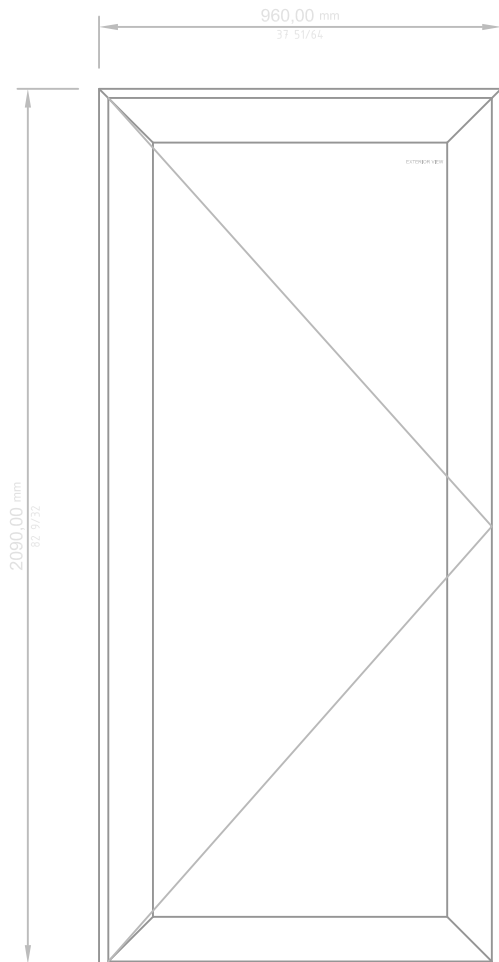

TVO-921



TVO-922



TVO-923



TVO-921

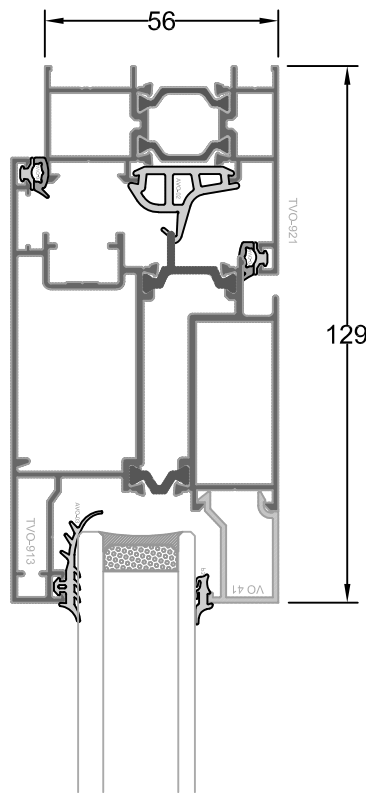

TVO-922

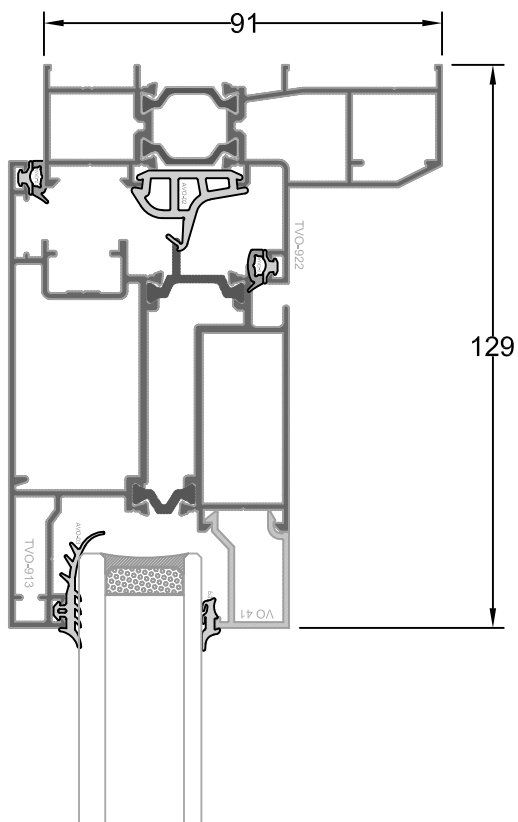

TVO-923

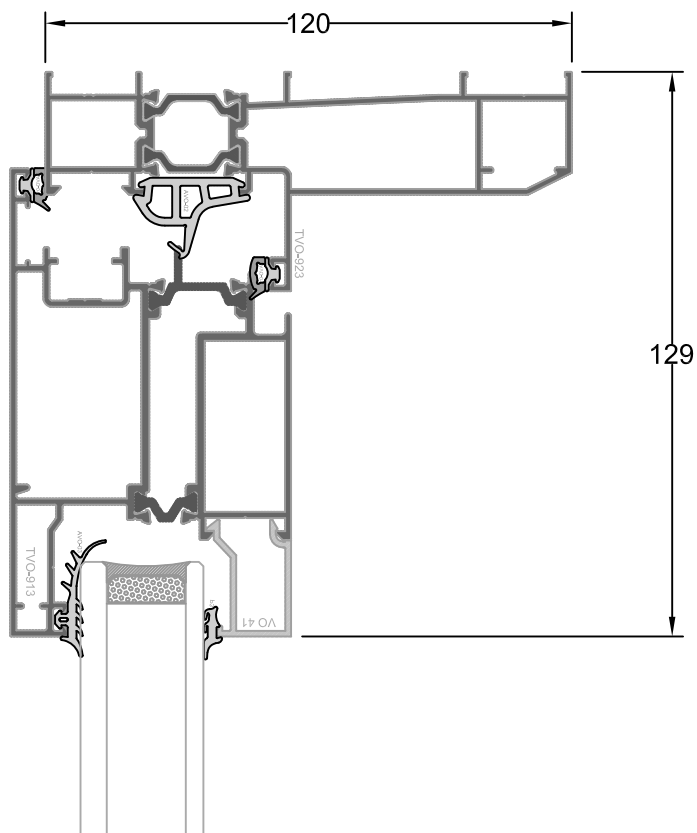

TVO-921

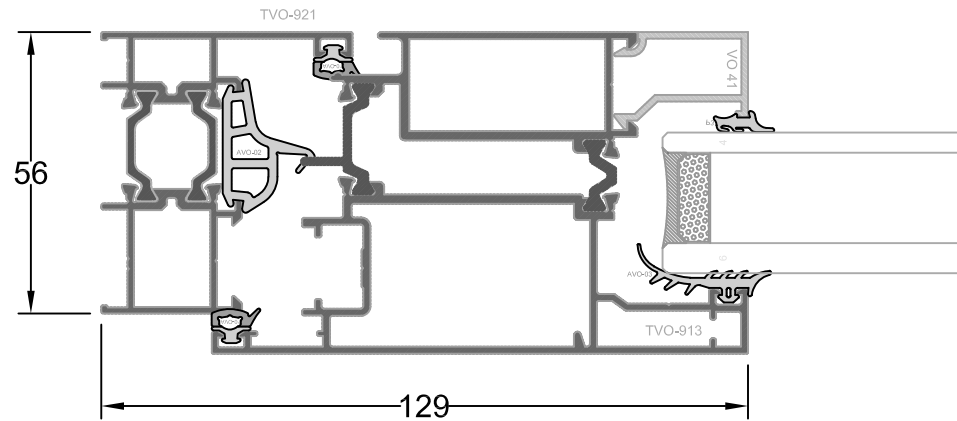

TVO-922

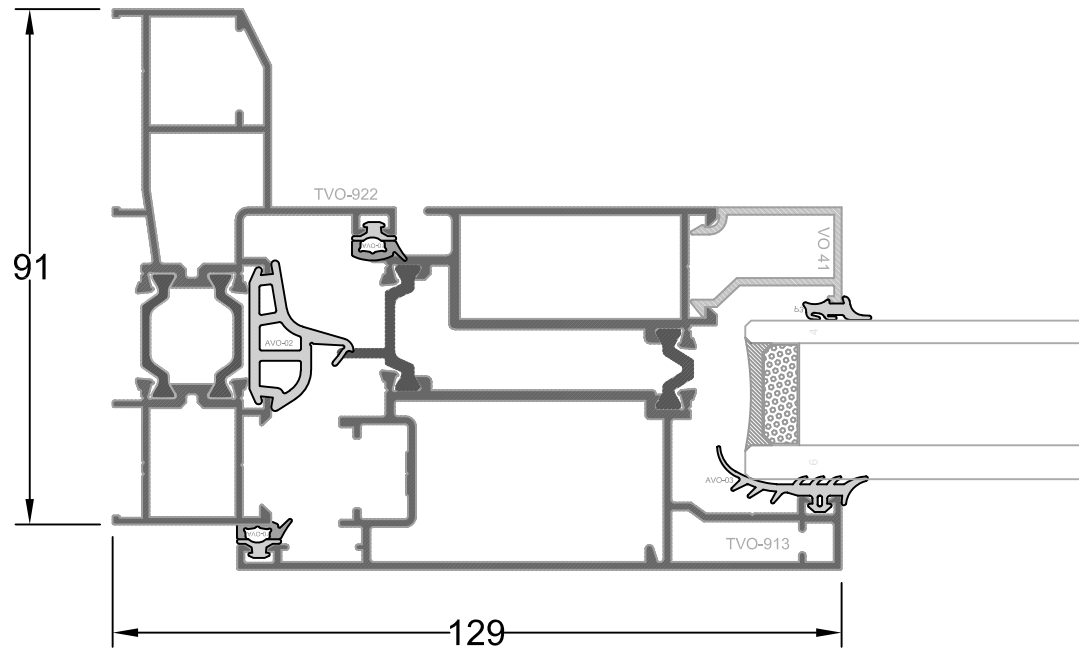

TVO-923

intertek
Total Quality. Assured.

Report #:	K0461.01-301-45
Date:	09/04/19
Verified by:	

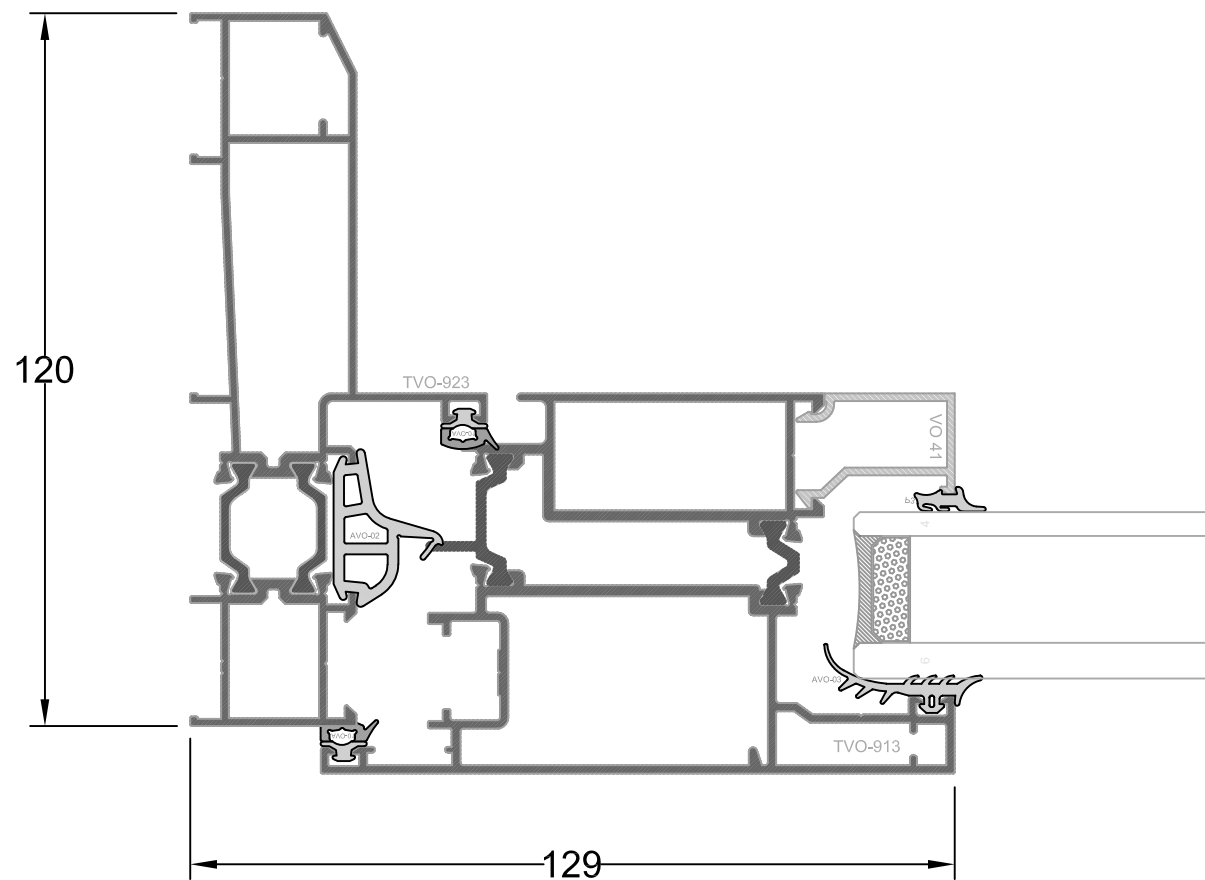

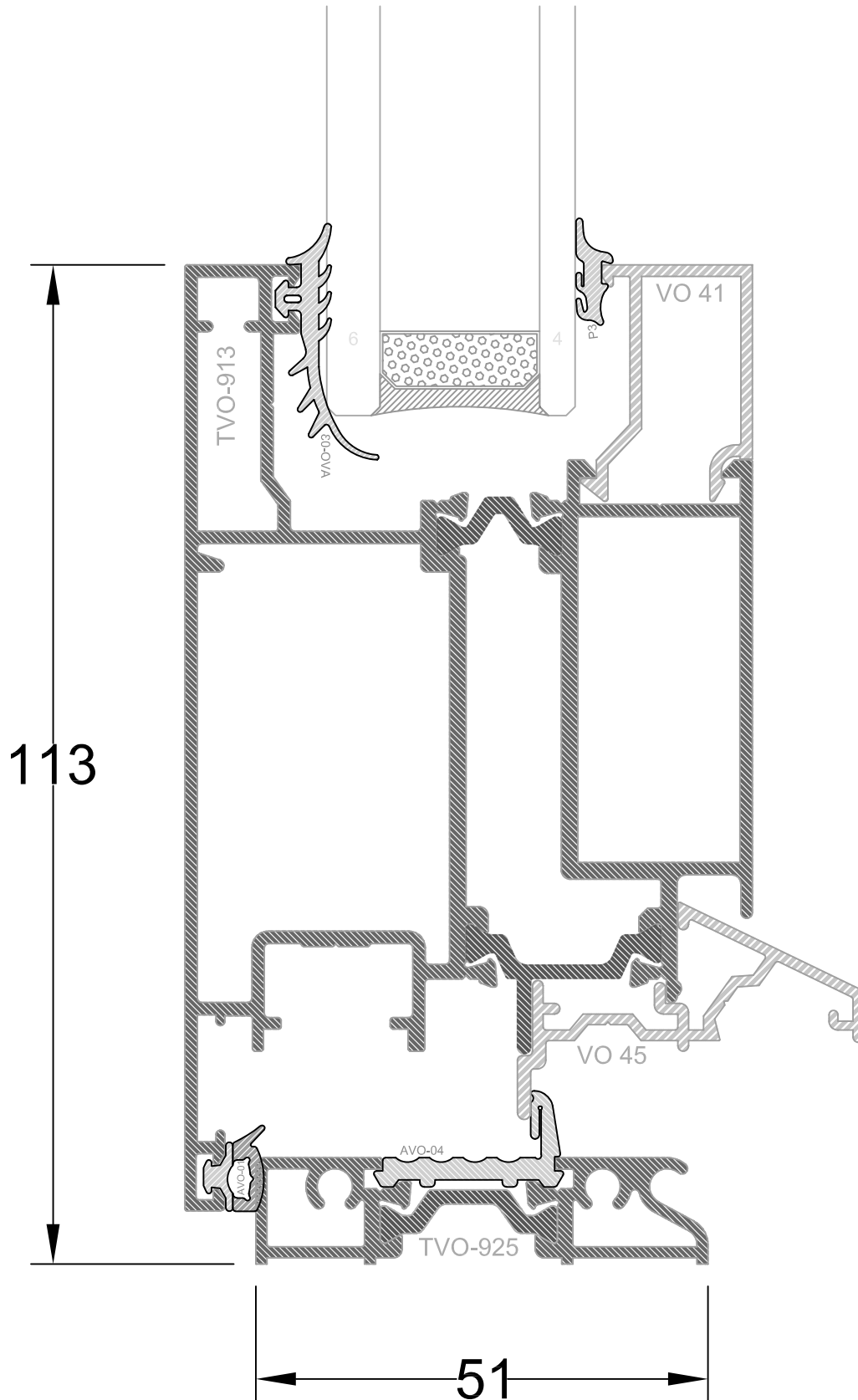

Ultra Outswing Door with Kickplate

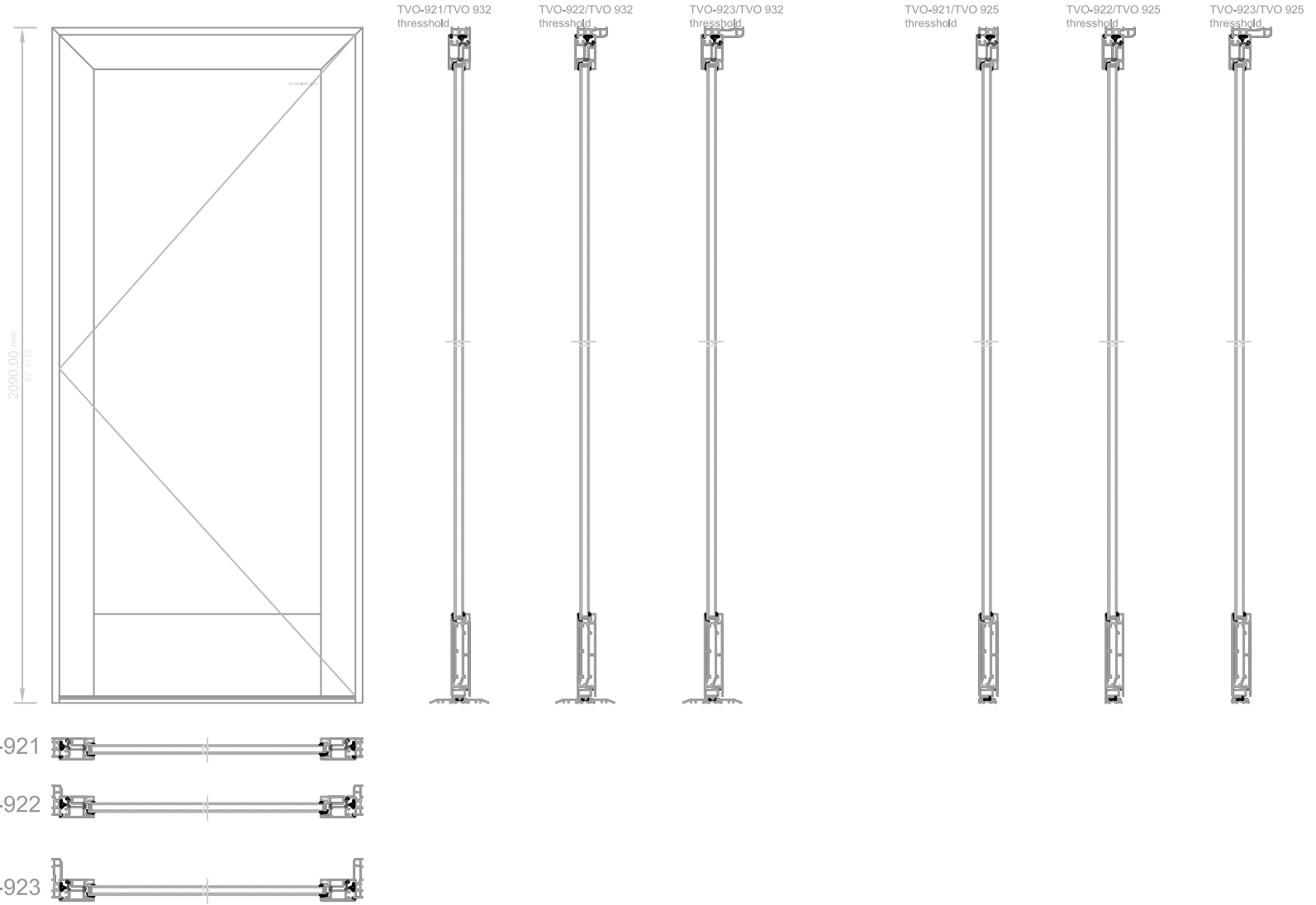

TVO-921

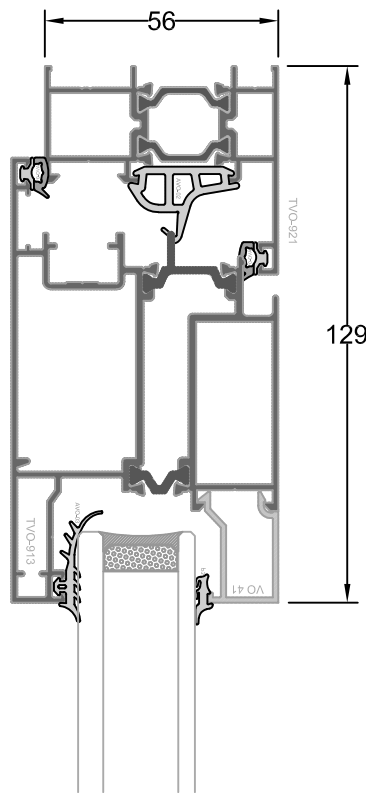

TVO-922

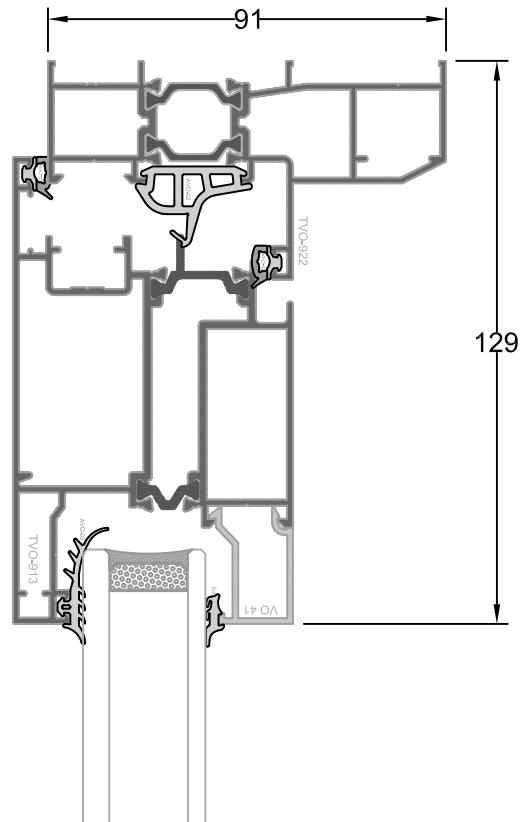

TVO-923

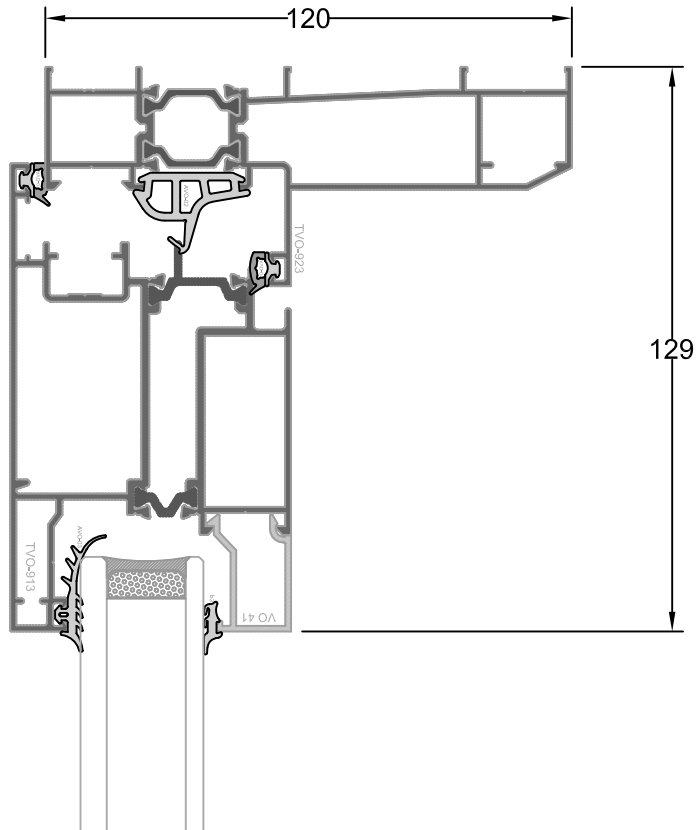

TVO-921

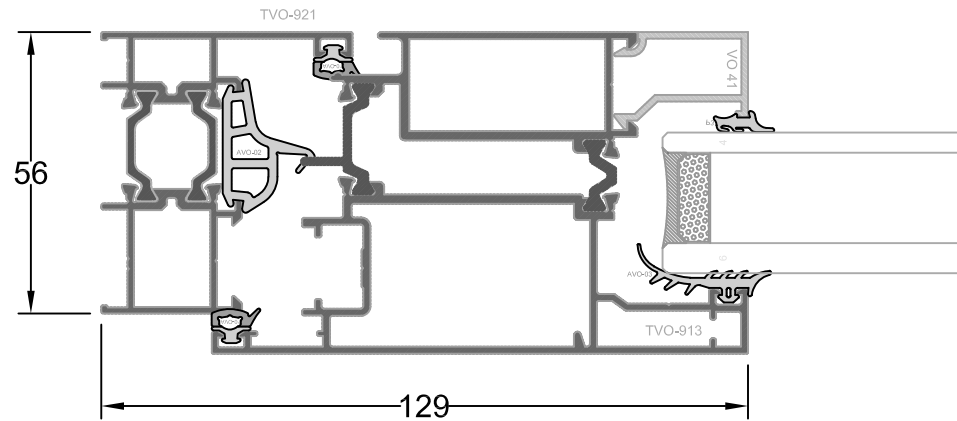

TVO-922

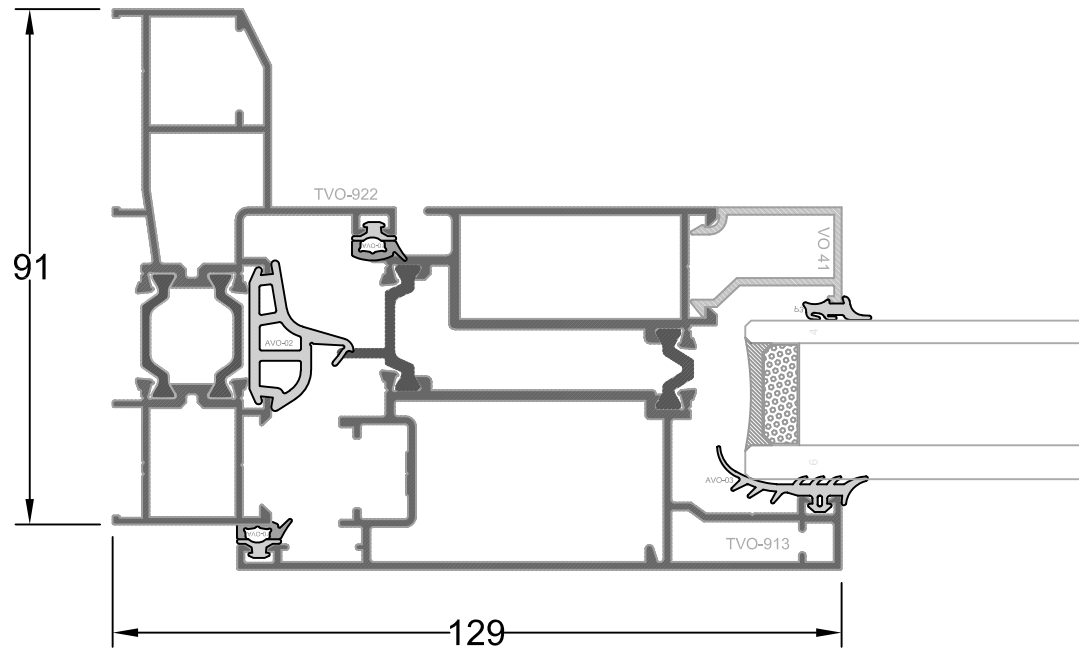

TVO-923

intertek
Total Quality. Assured.

Report #: K0461.01-301-45

Date: 09/04/19

Verified by: *D.J. Smith*

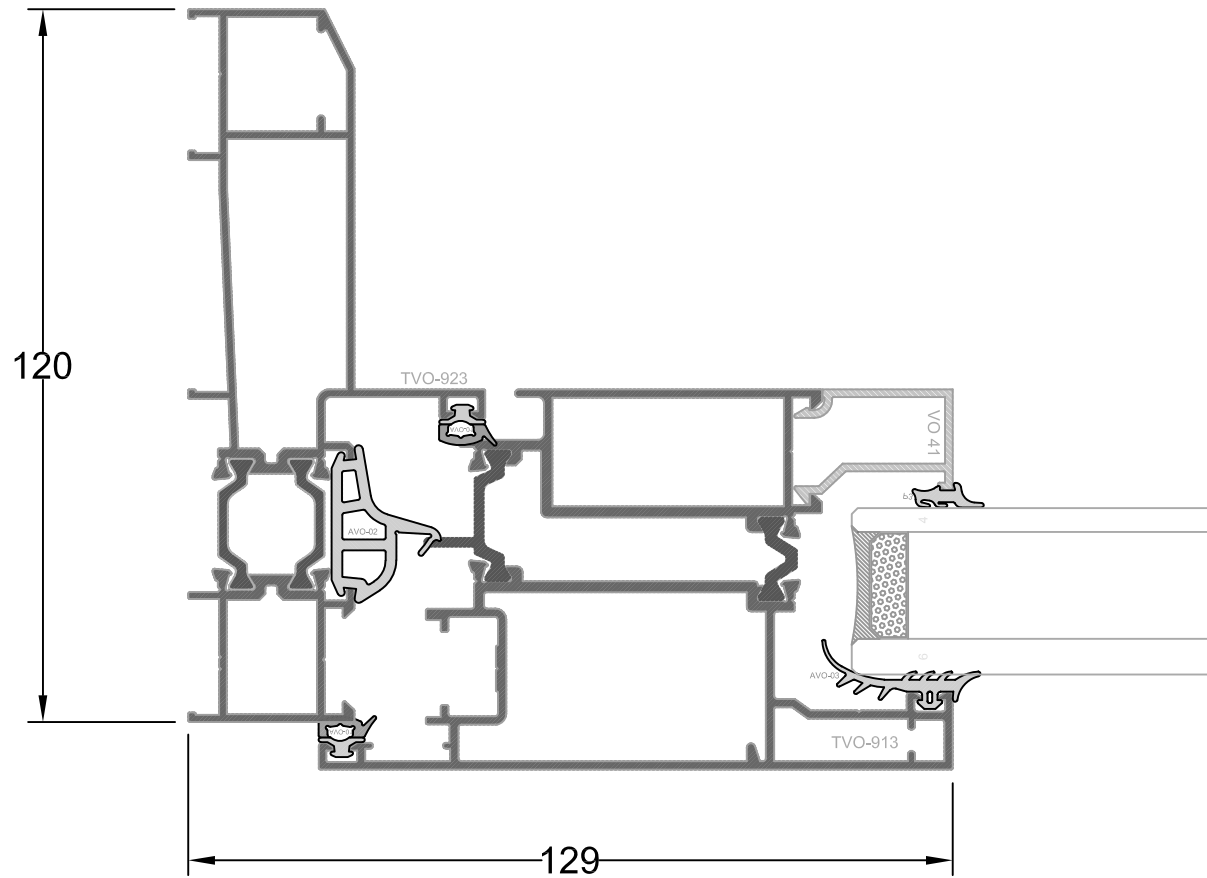

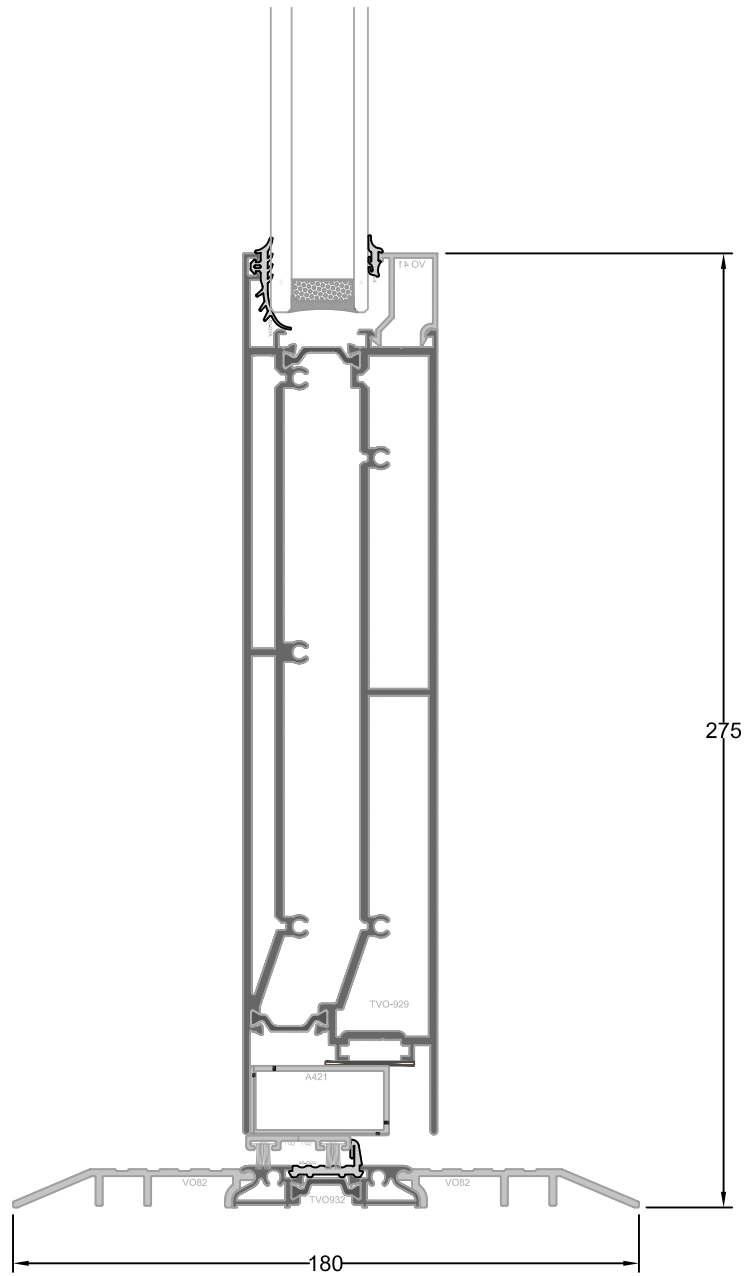

TVO 932 thresshold

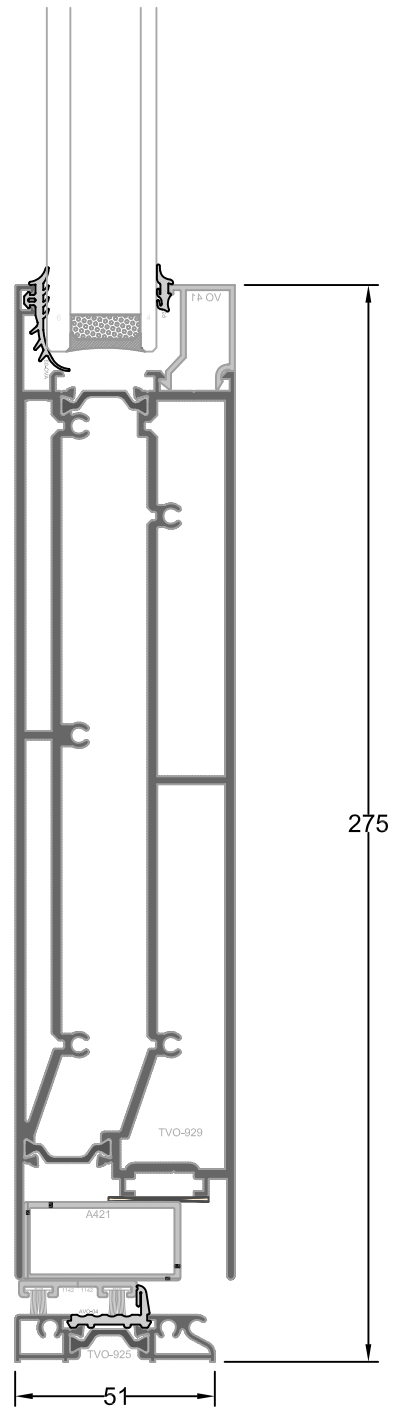

TVO 925 thresshold

Part #1

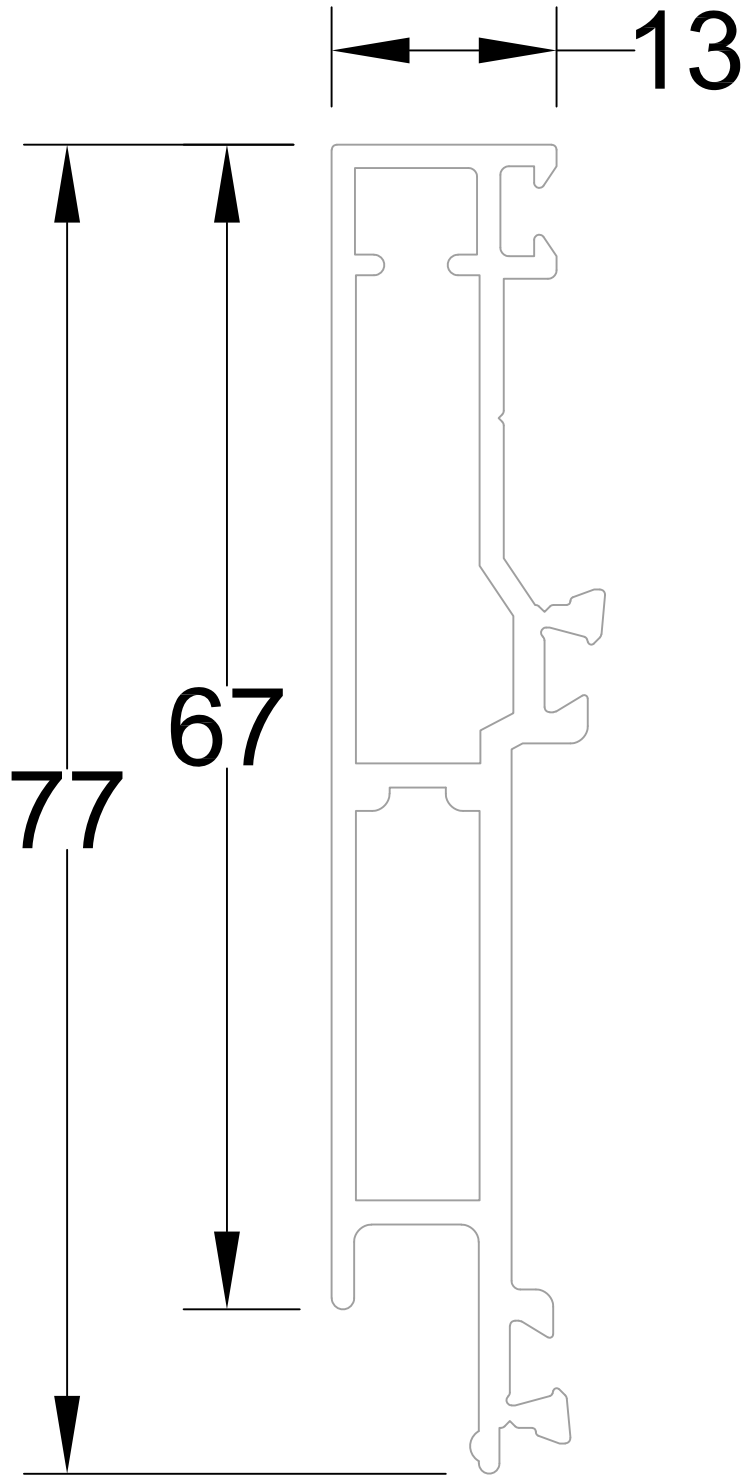

Part #2

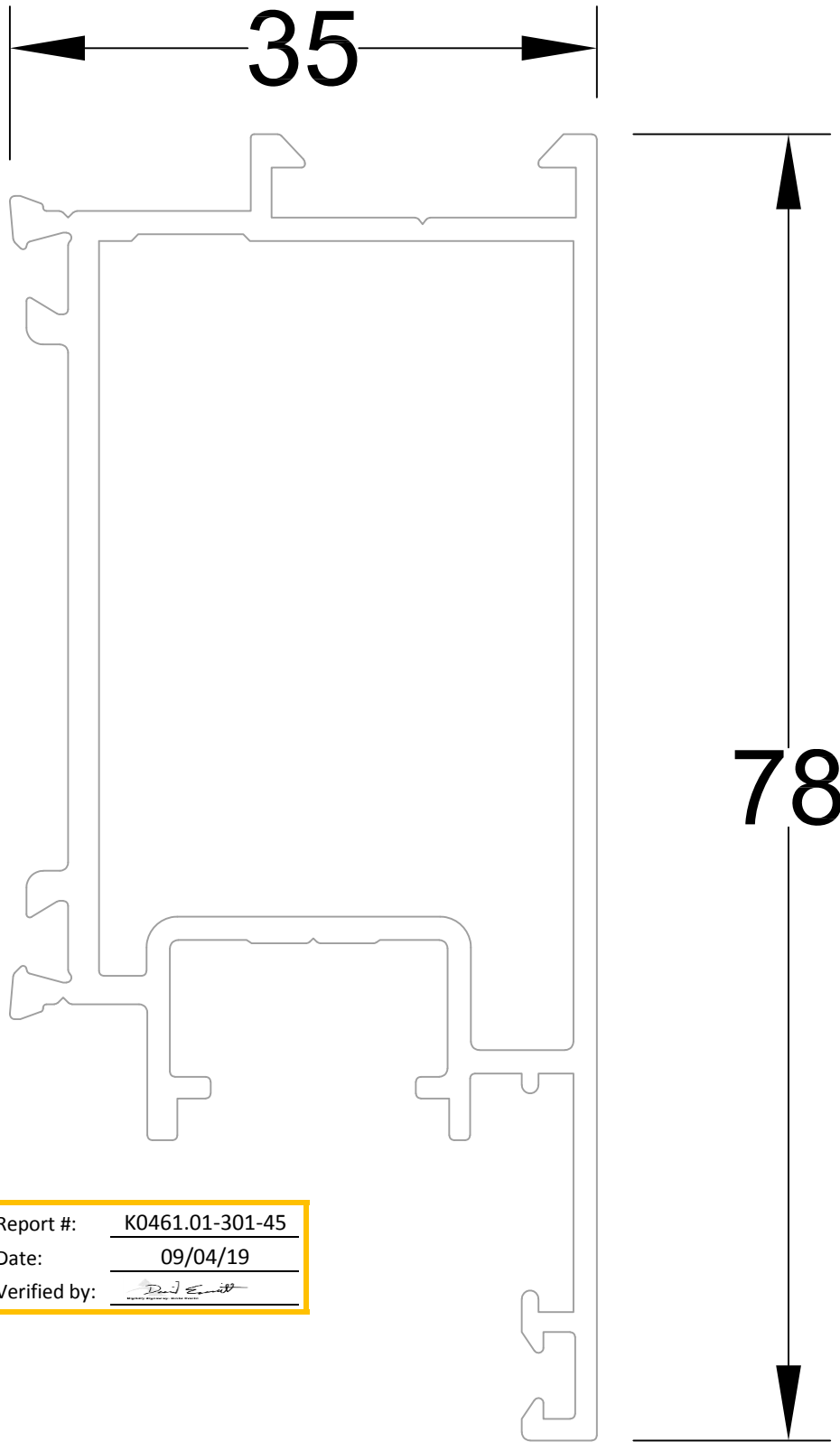

intertek Total Quality. Assured.	Report #:	K0461.01-301-45
	Date:	09/04/19
	Verified by:	

Part #3

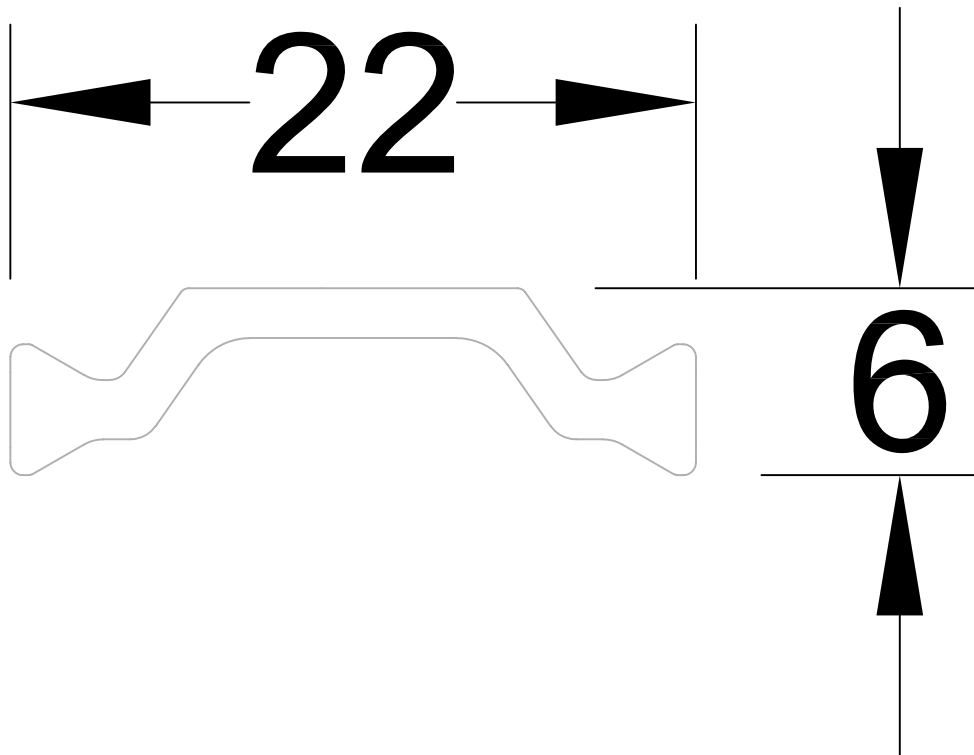

Part #4

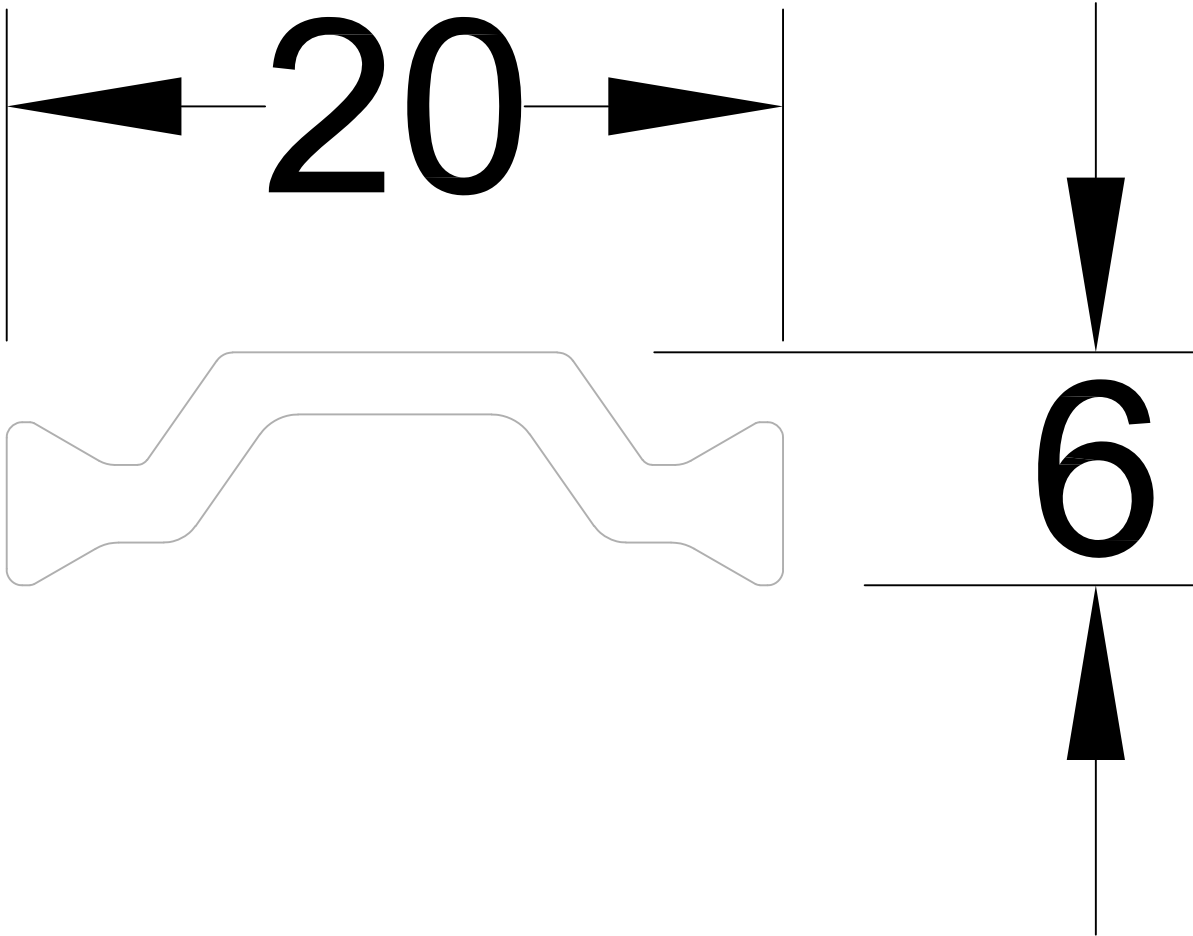

Part #5

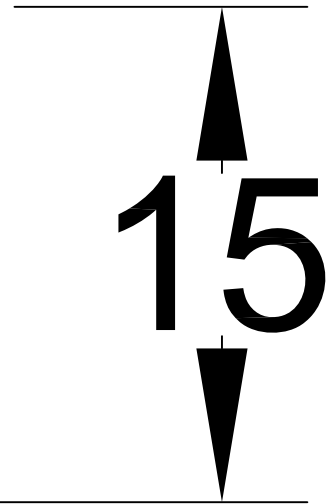
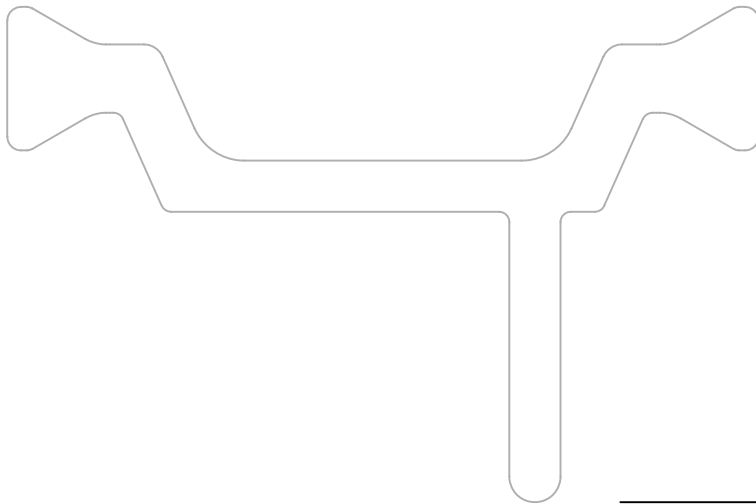

Part #6

intertek
Total Quality. Assured.

Report #: K0461.01-301-45

Date: 09/04/19

Verified by: 

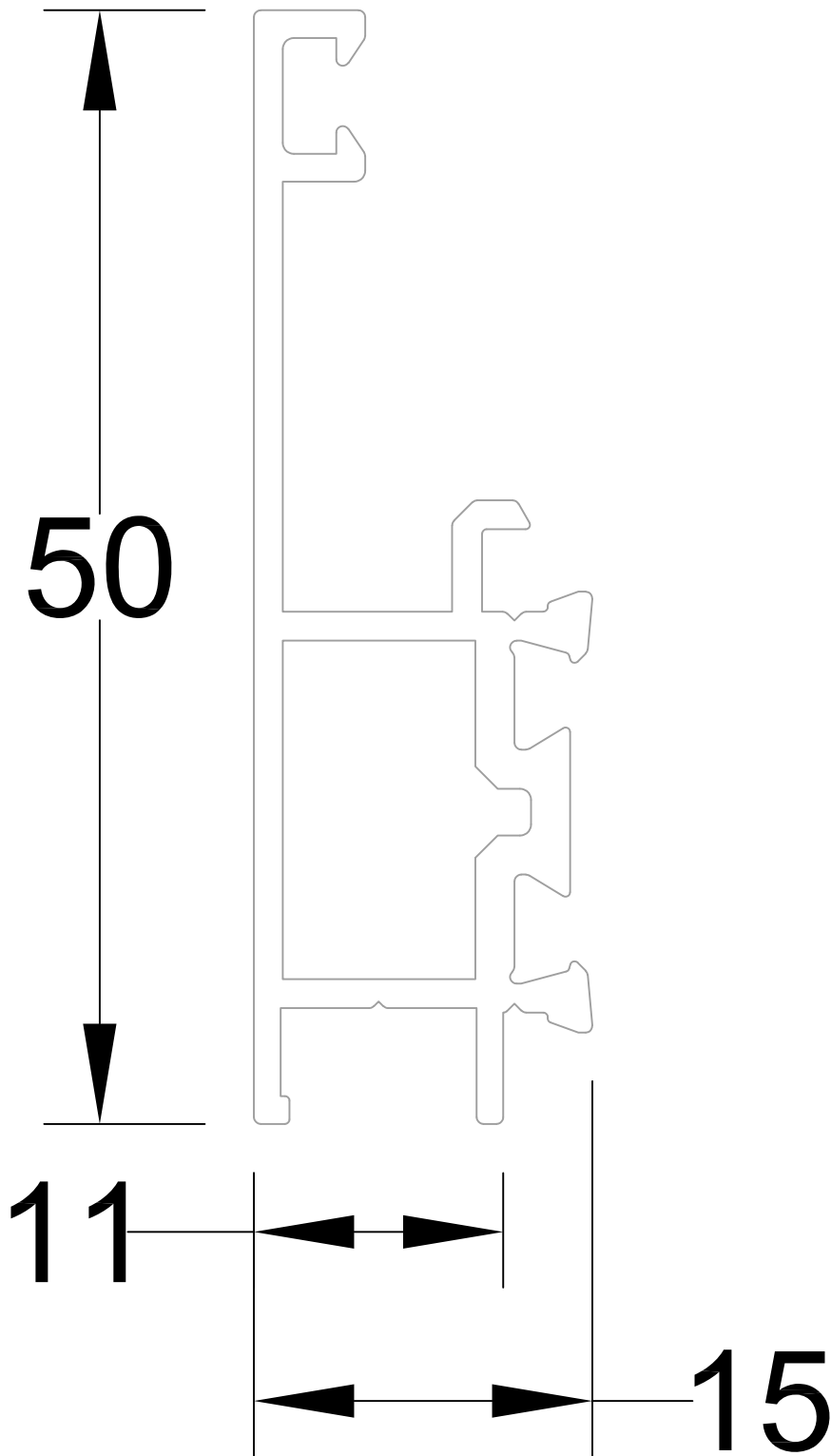

Part #7

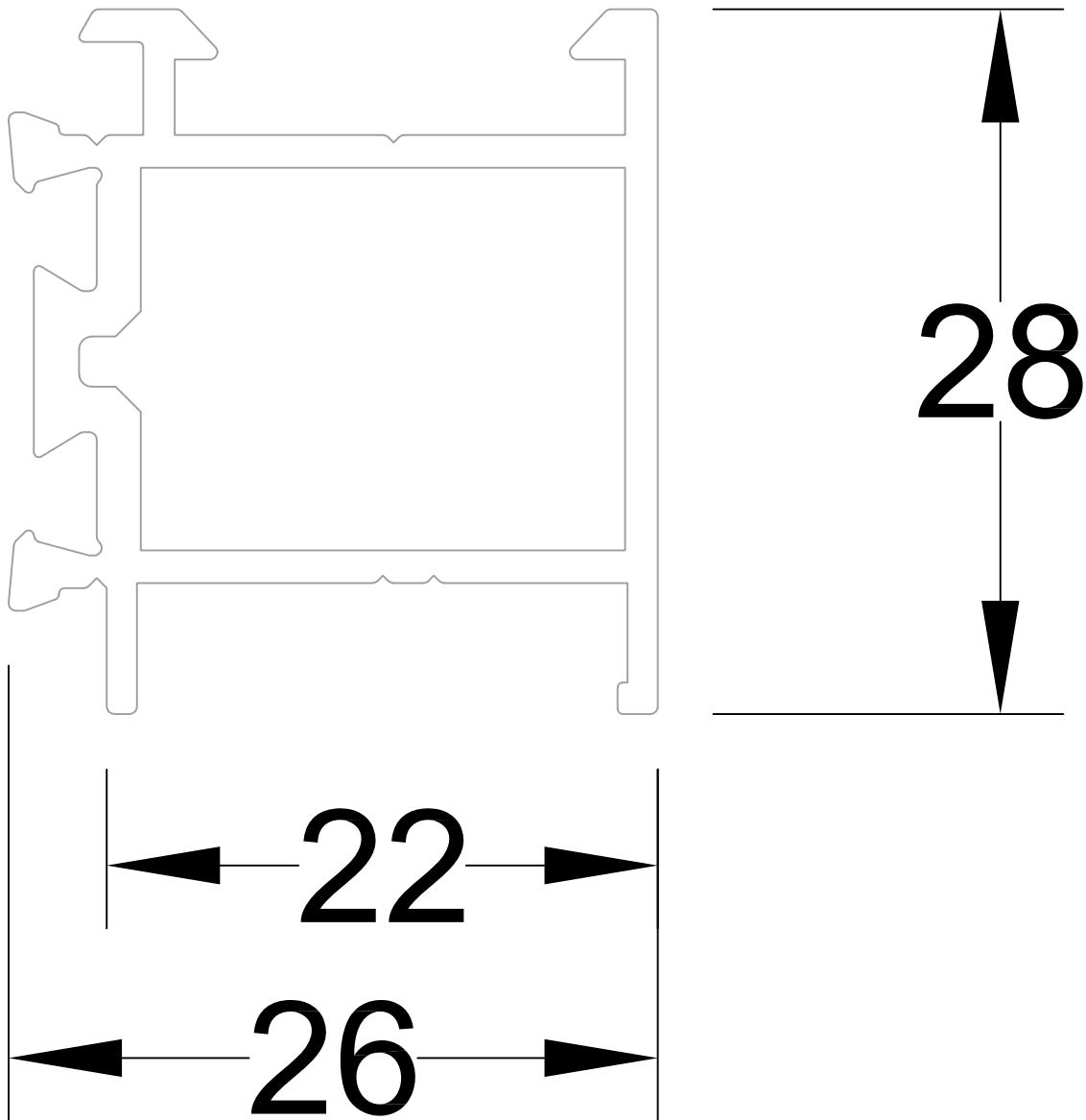

Part #8

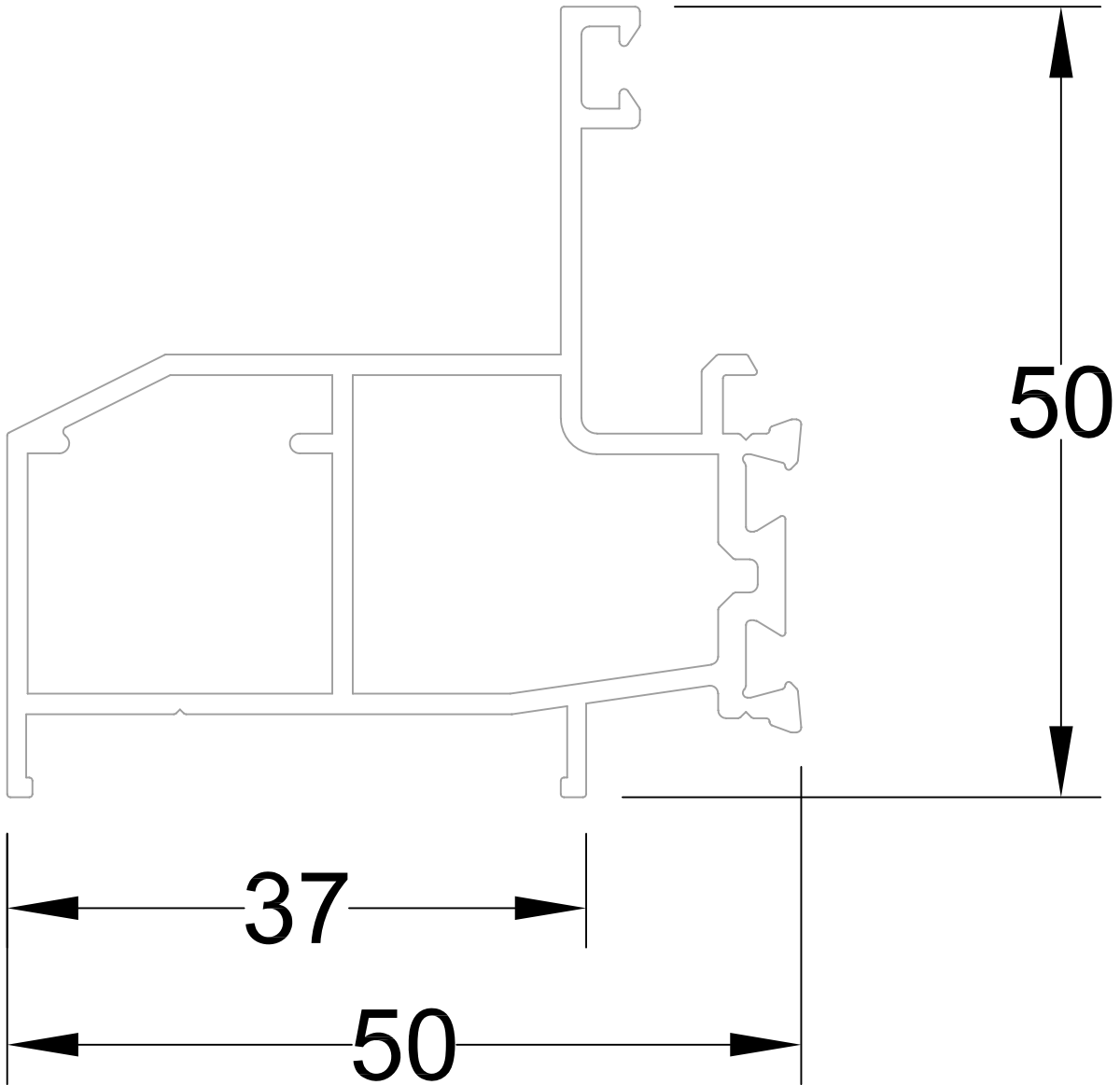

Part #9

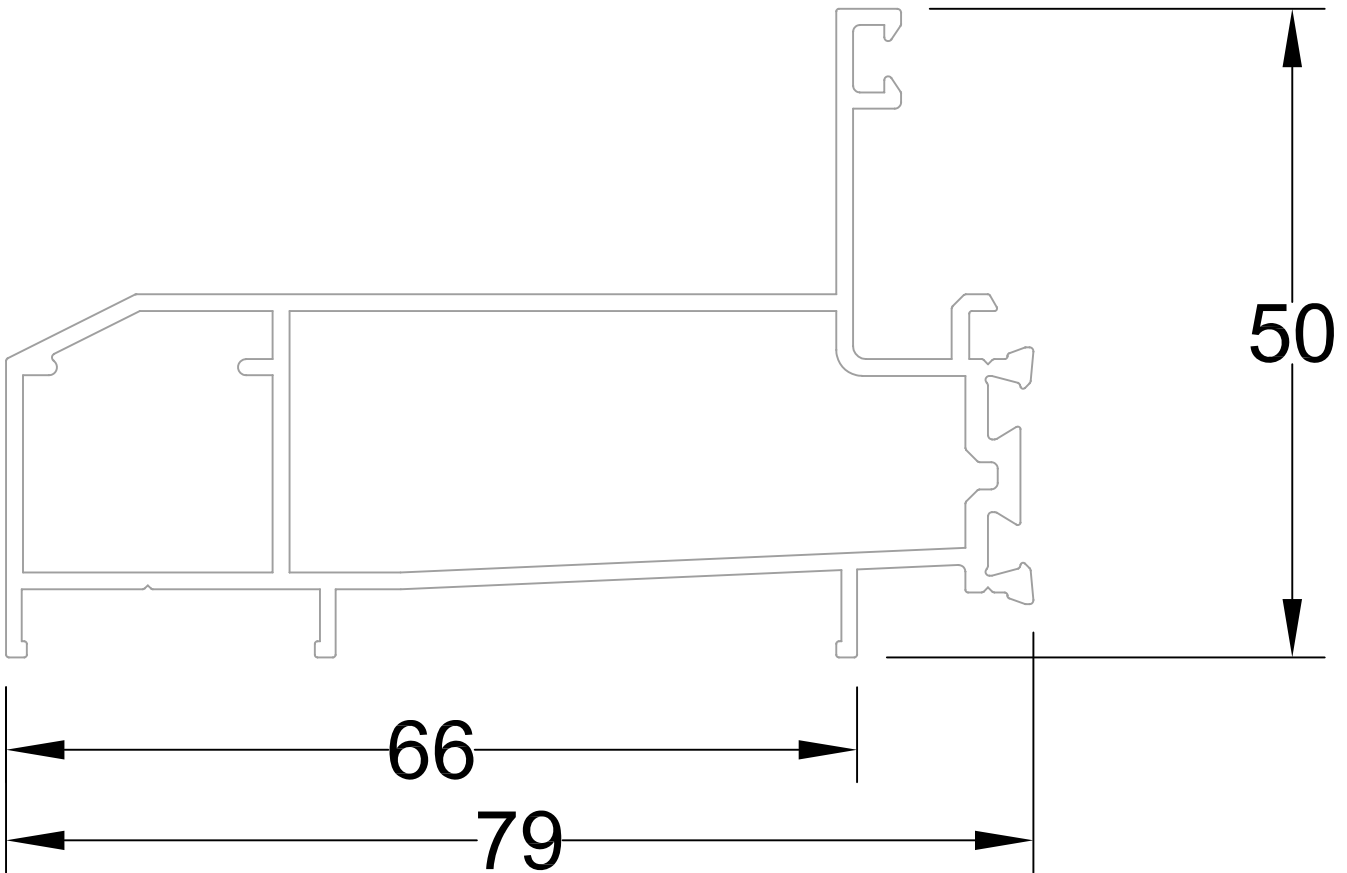

Part #10

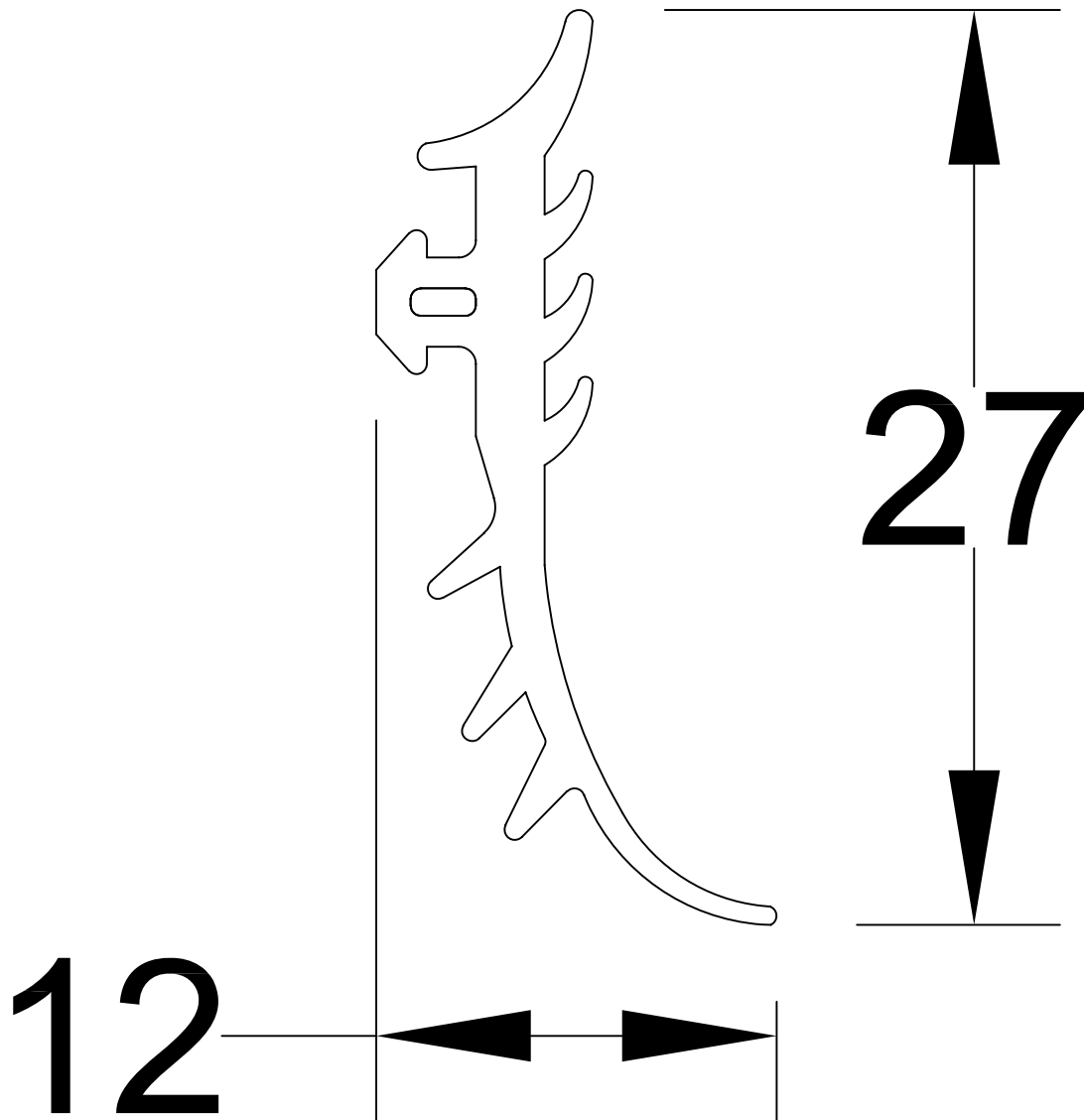

Part #11

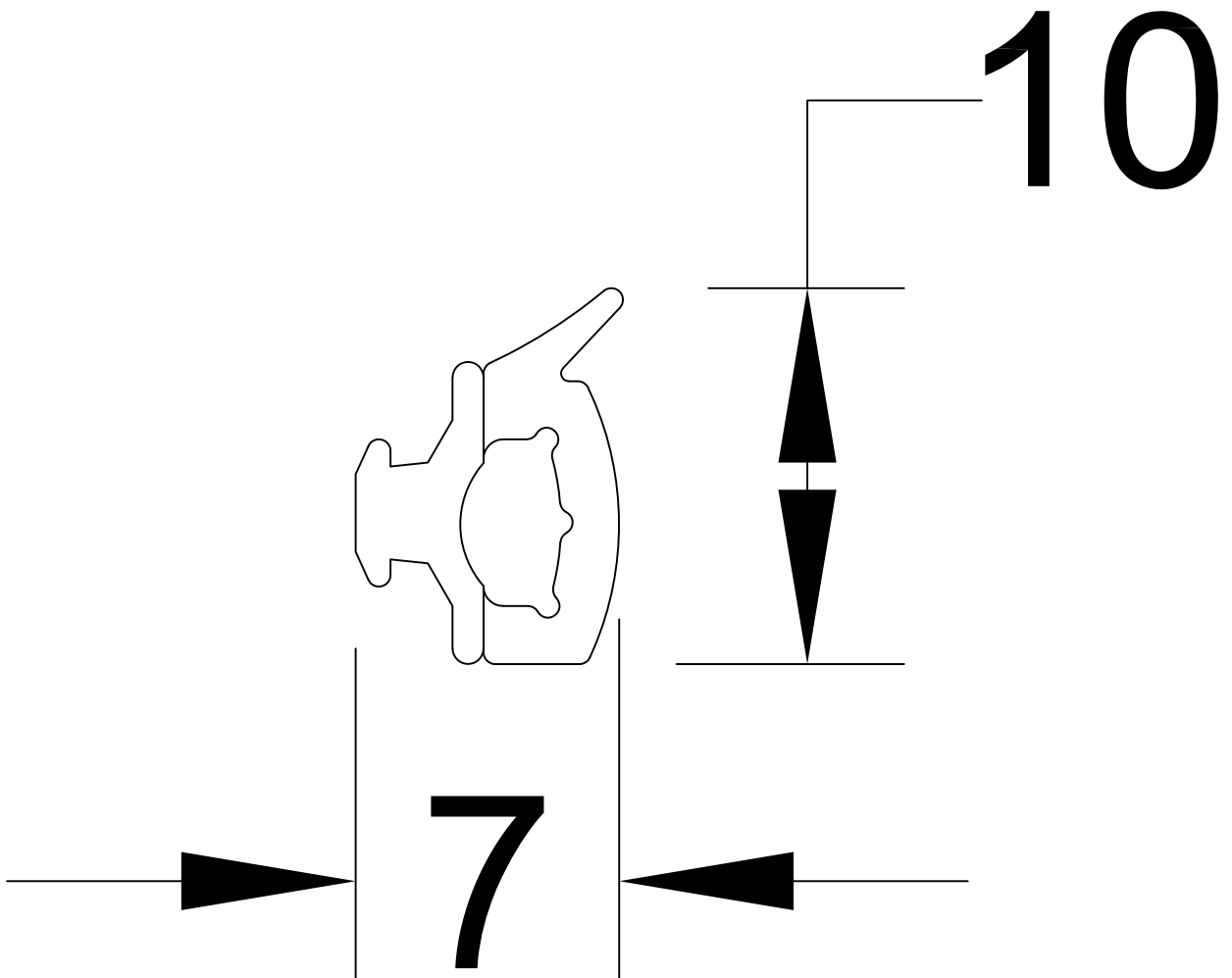

← 17 →

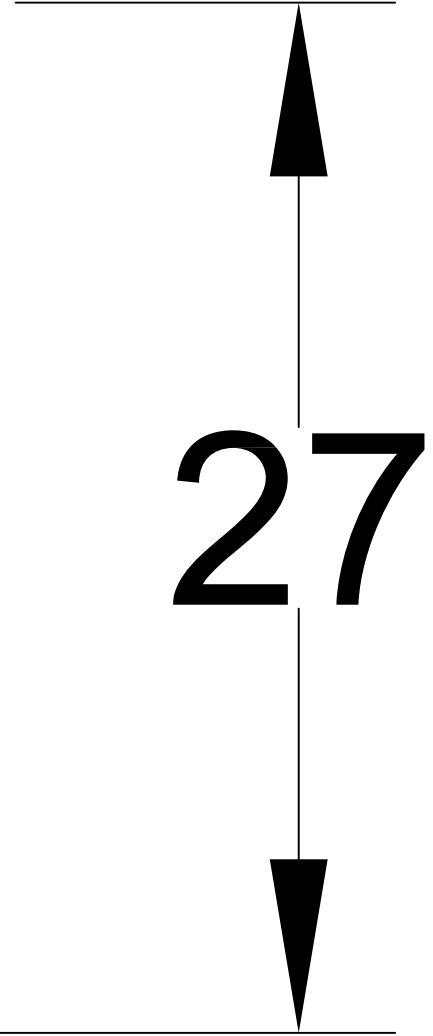
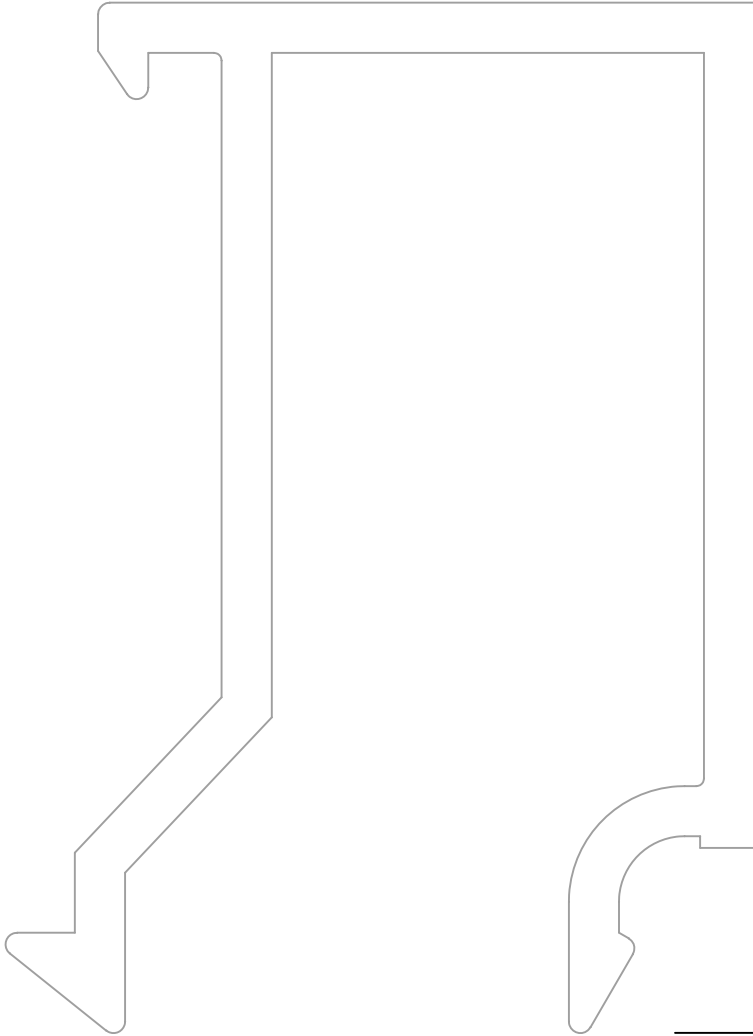

Part #12

Part #13

12

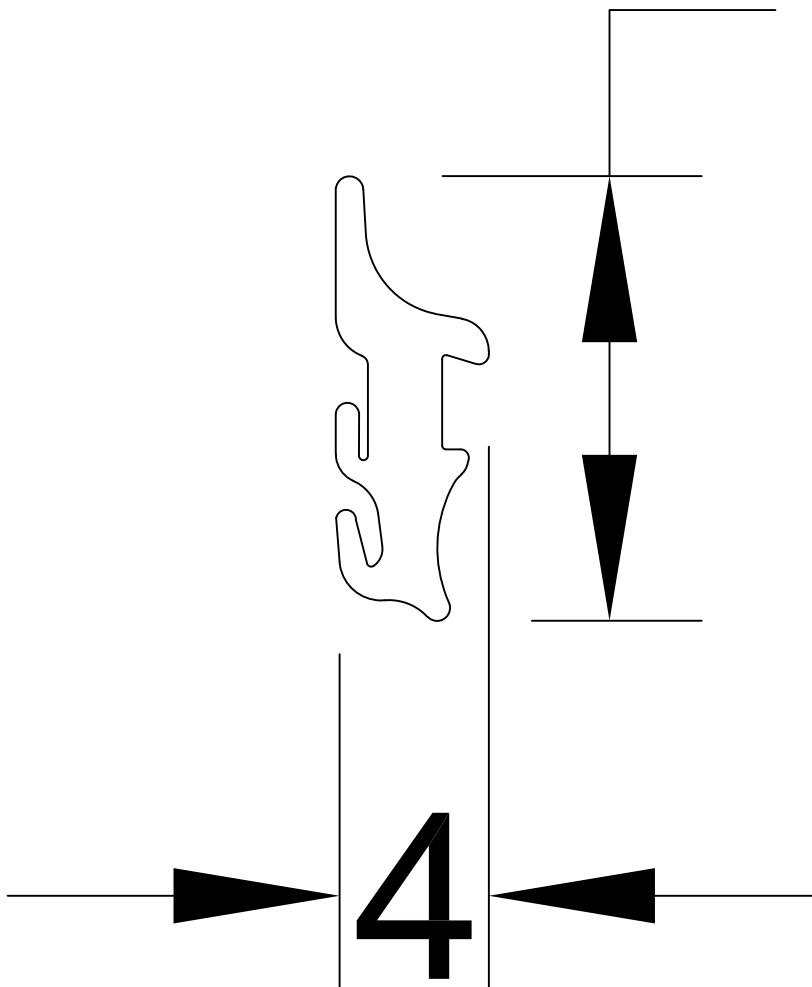

Part #14

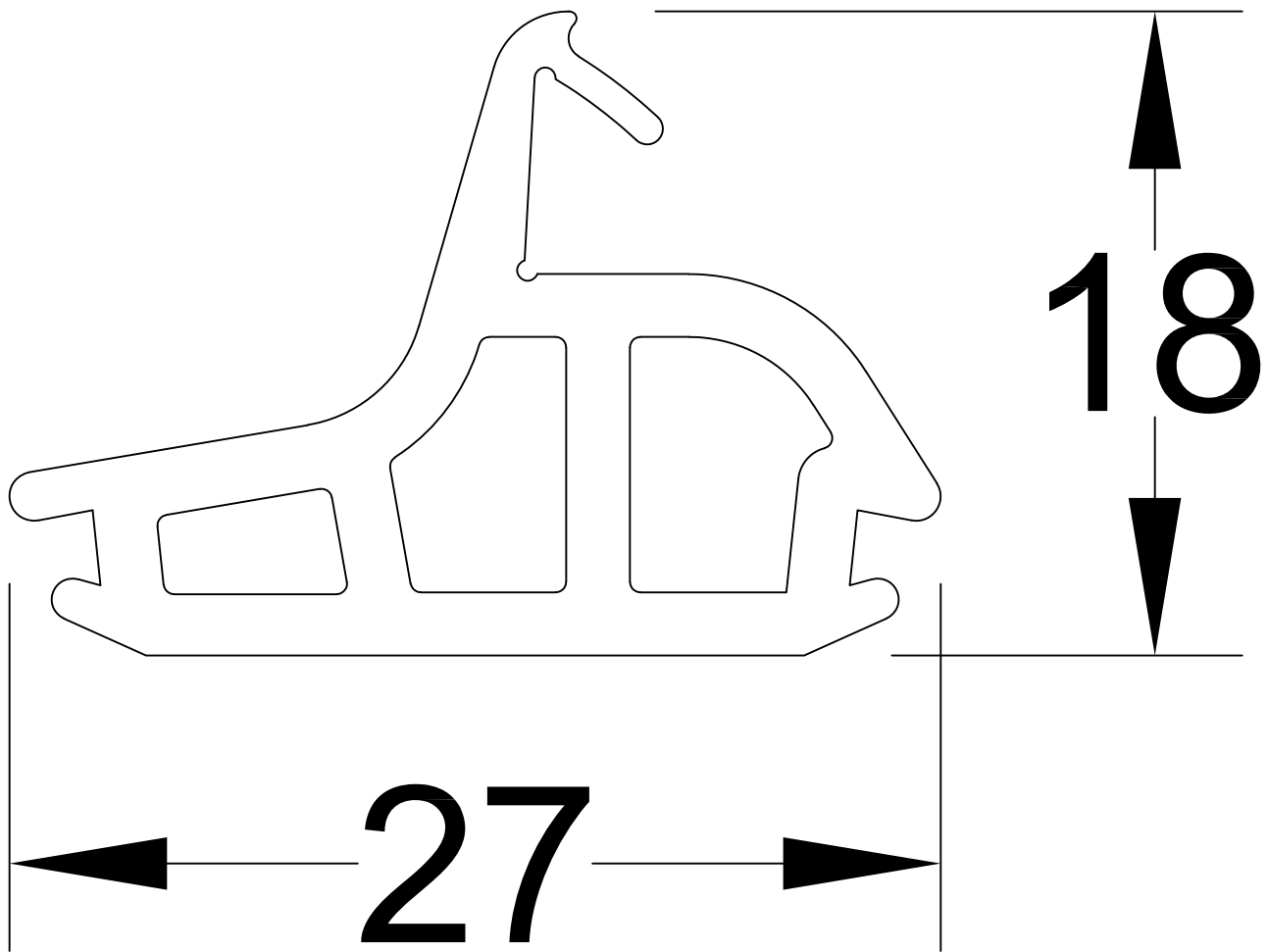

Part #15

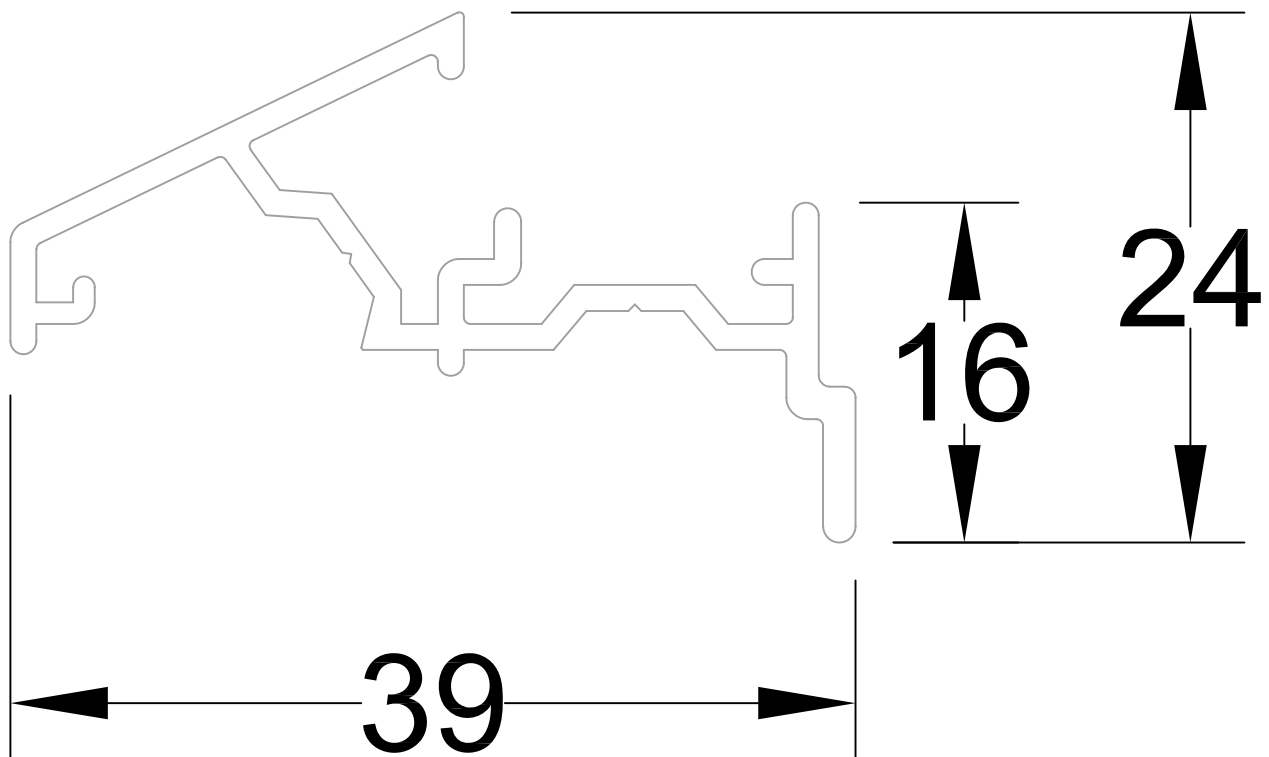

Part #16

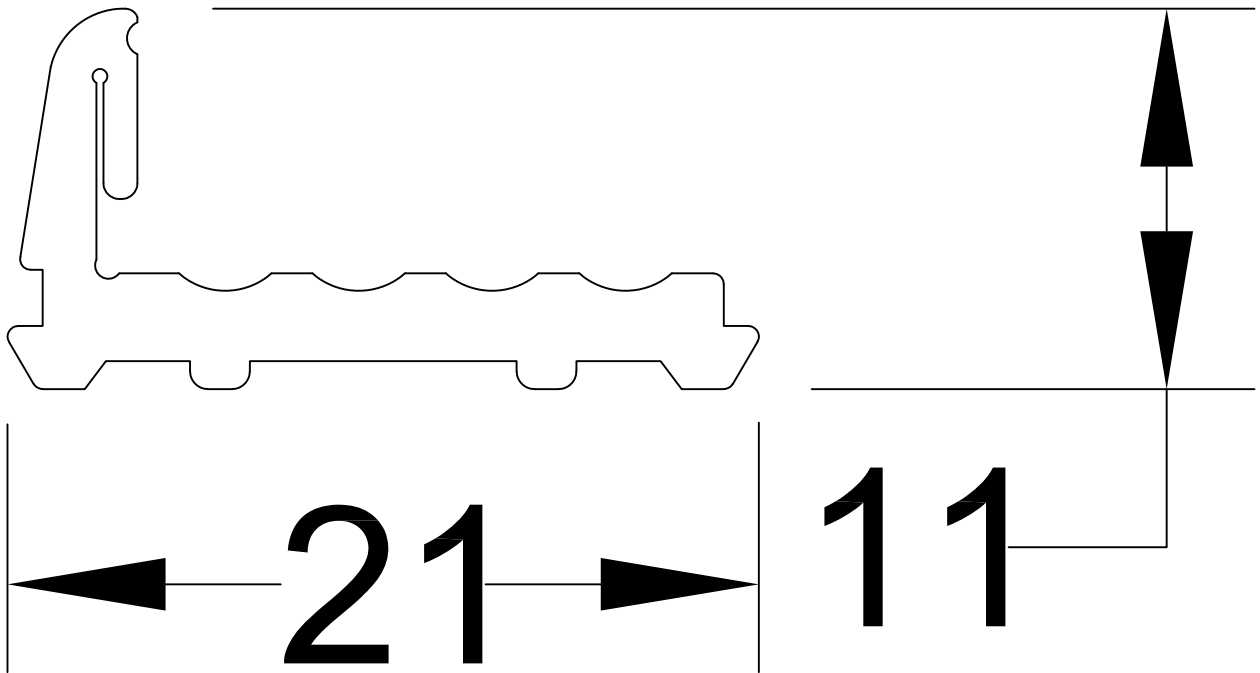

Part #17

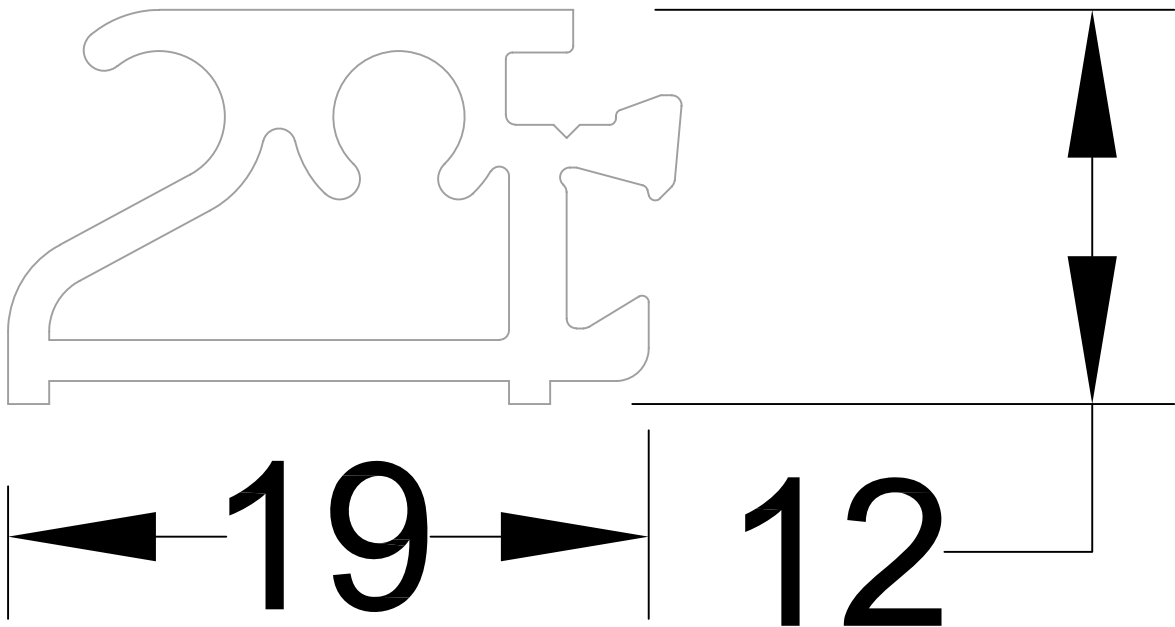

Part #18

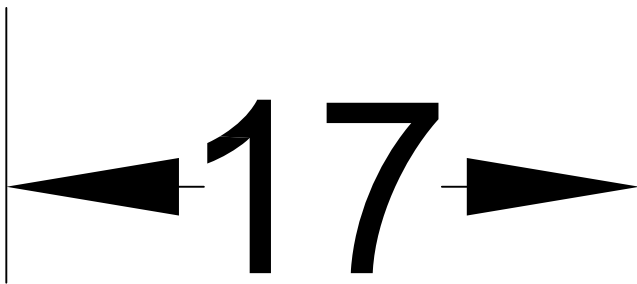
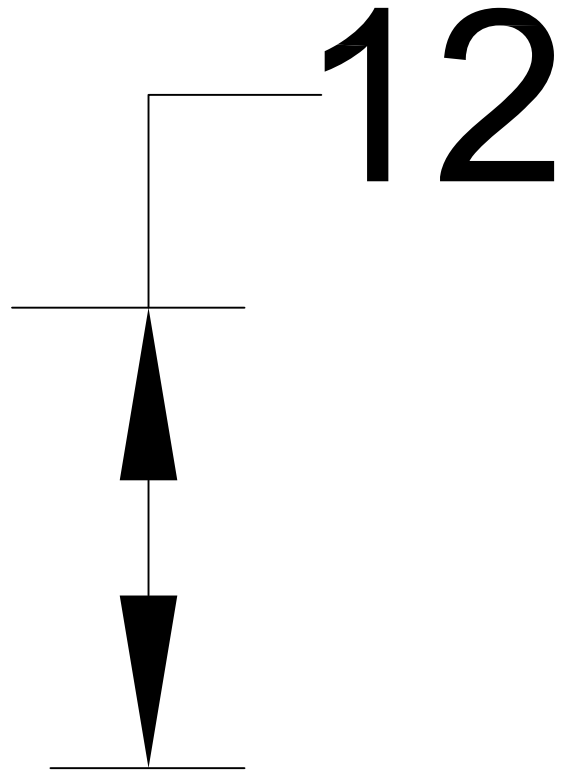
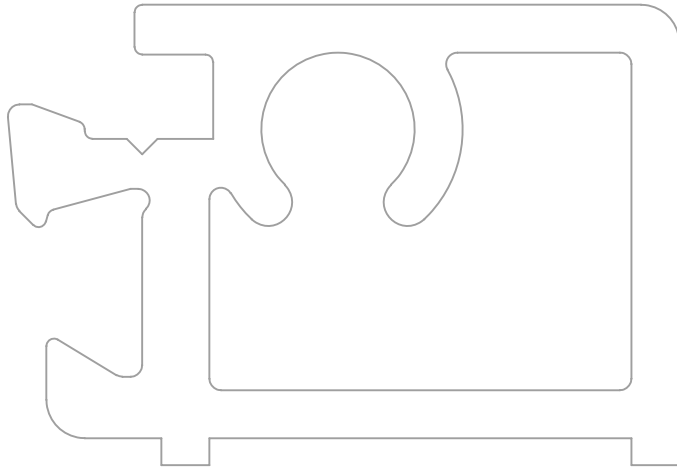

Part #19

intertek
Total Quality. Assured.

Report #: K0461.01-301-45

Date: 09/04/19

Verified by: *[Signature]*

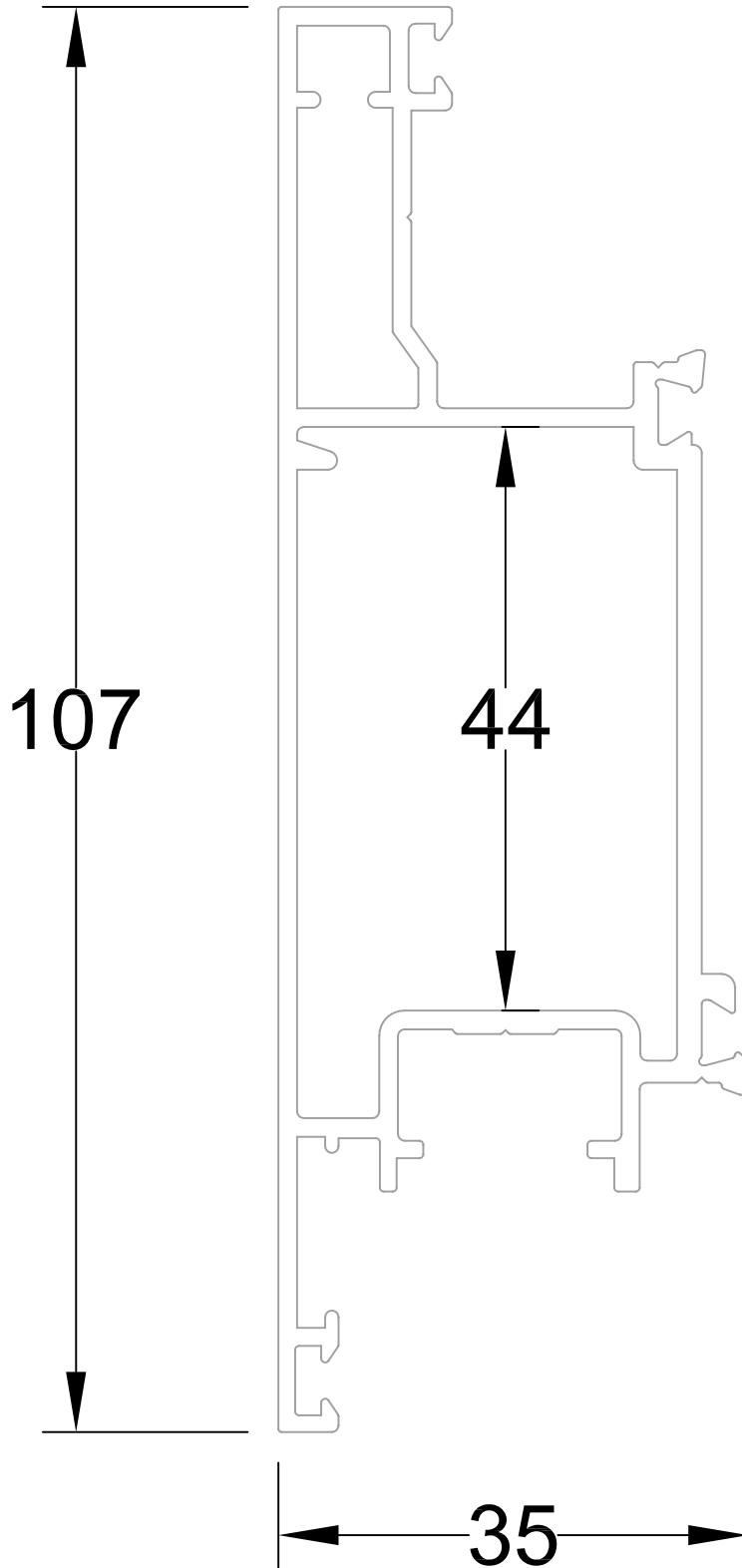

Part #20

intertek Total Quality. Assured.	Report #:	K0461.01-301-45
	Date:	09/04/19
	Verified by:	

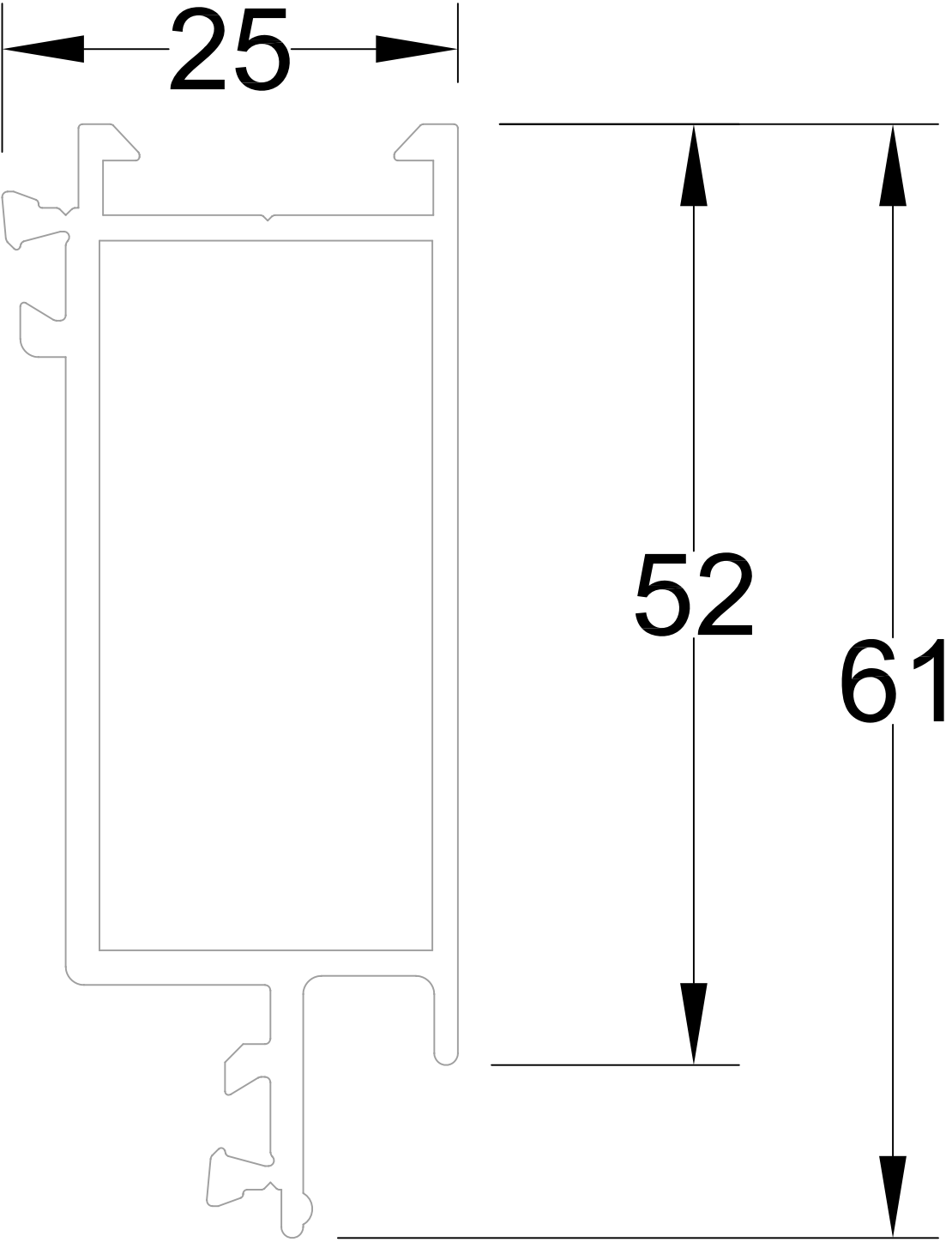

Part #21

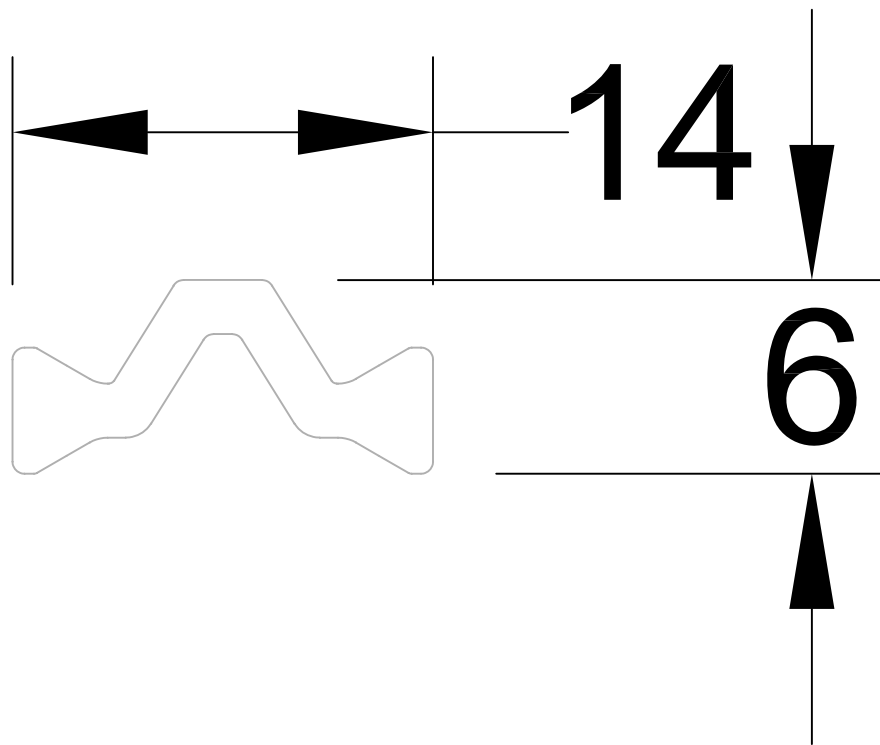

Part #22

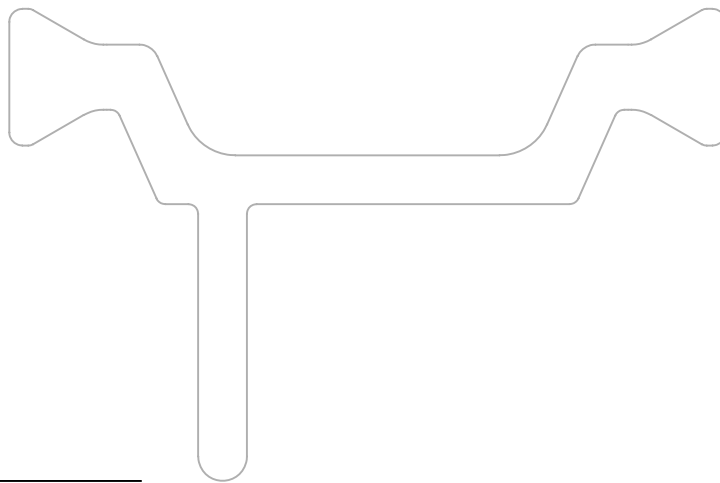
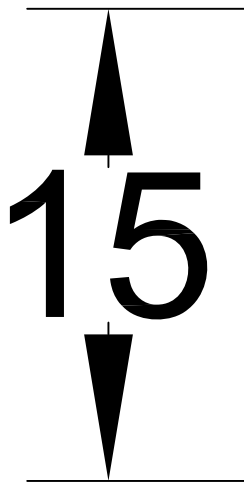
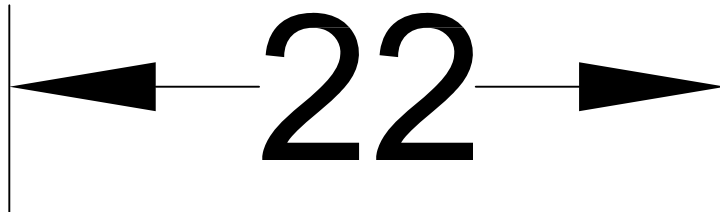

Part #23

intertek Total Quality. Assured.	Report #:	K0461.01-301-45
	Date:	09/04/19
	Verified by:	 DAVID SMITH

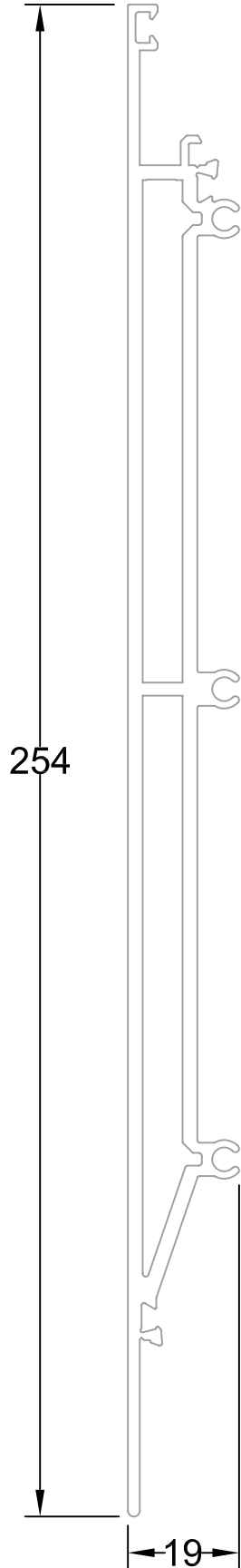

Part #24

intertek
Total Quality. Assured.

Report #: K0461.01-301-45

Date: 09/04/19

Verified by: 

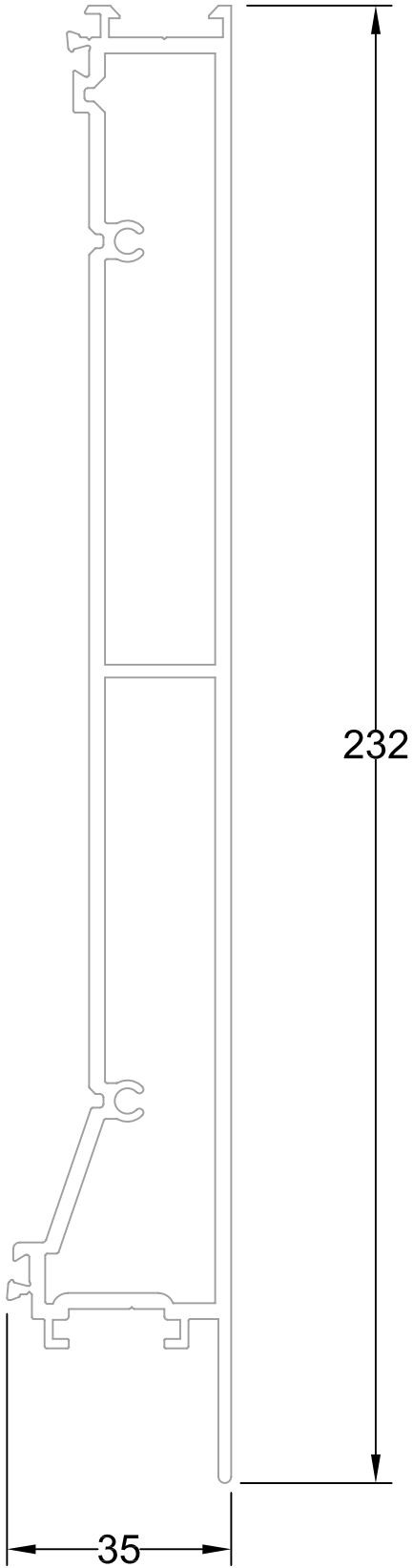

Part #26

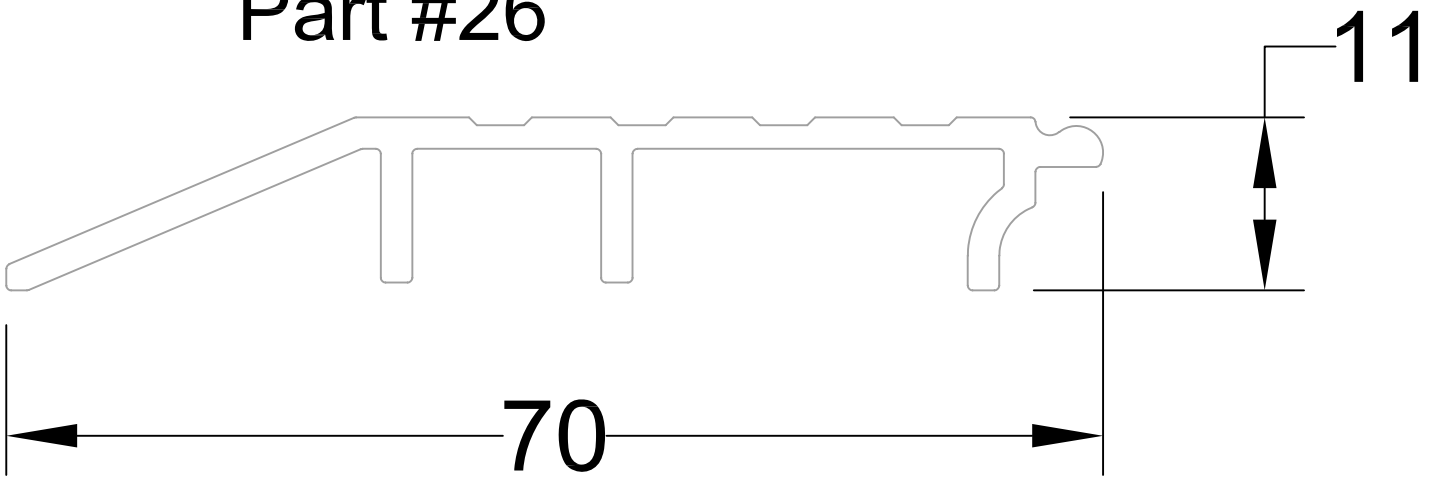

Part #27

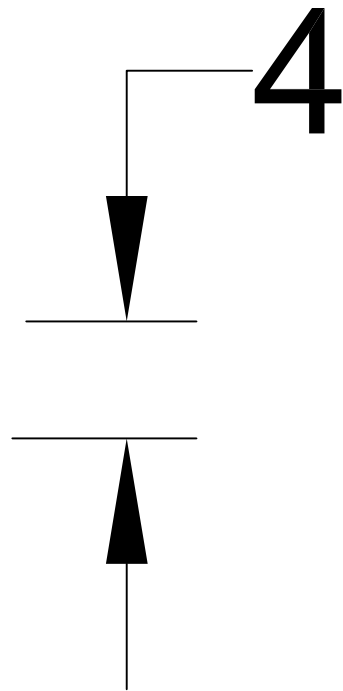
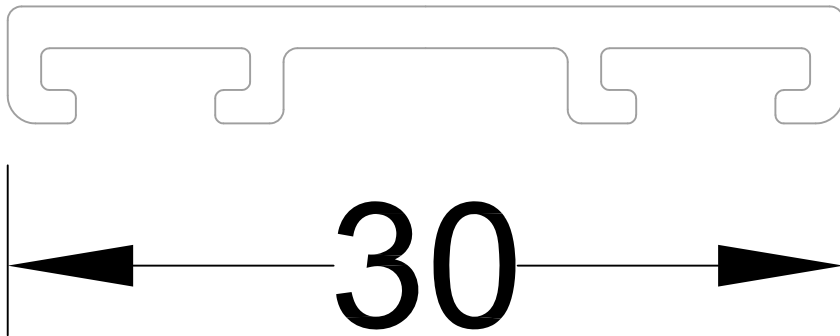

Part #28

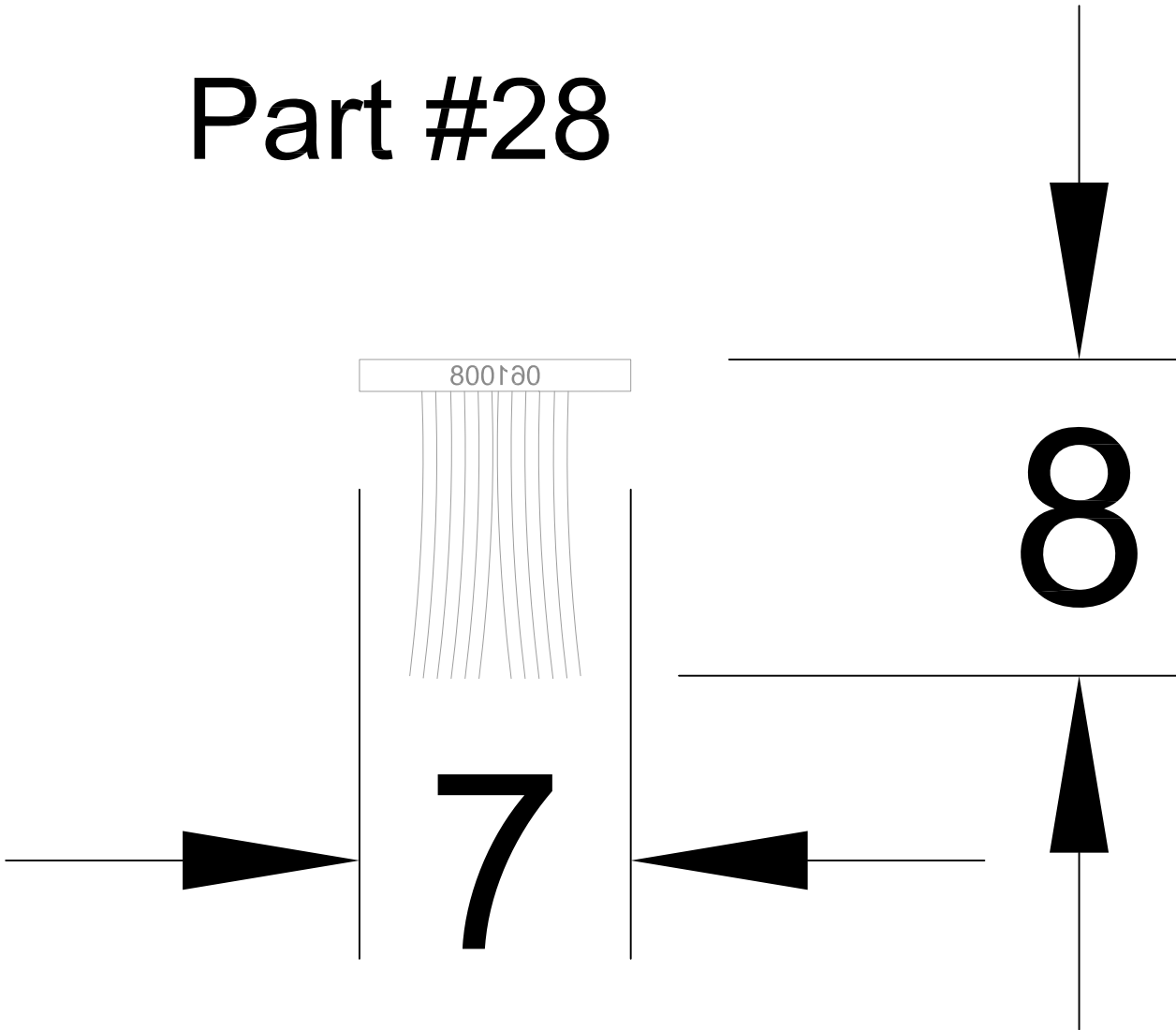

Part #29

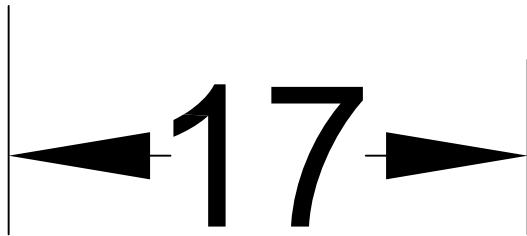
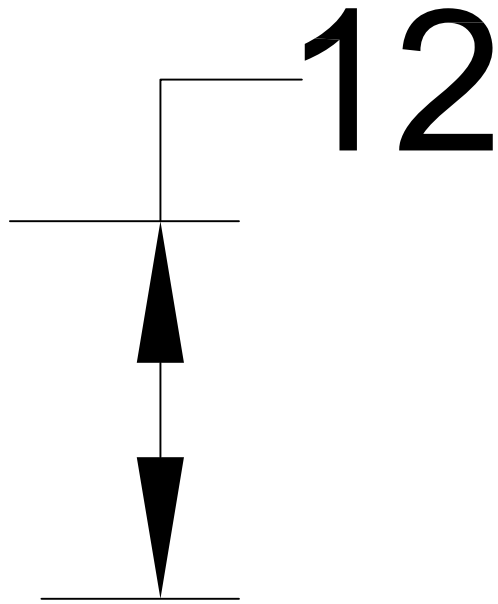
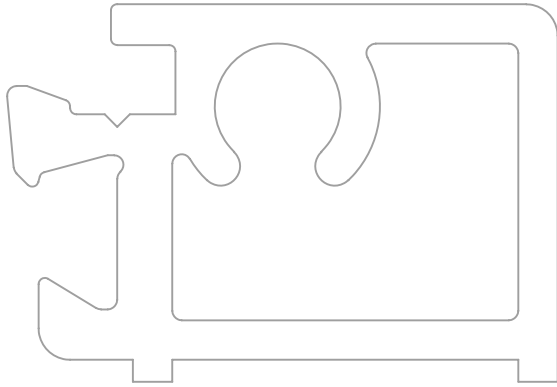

TDL Profile

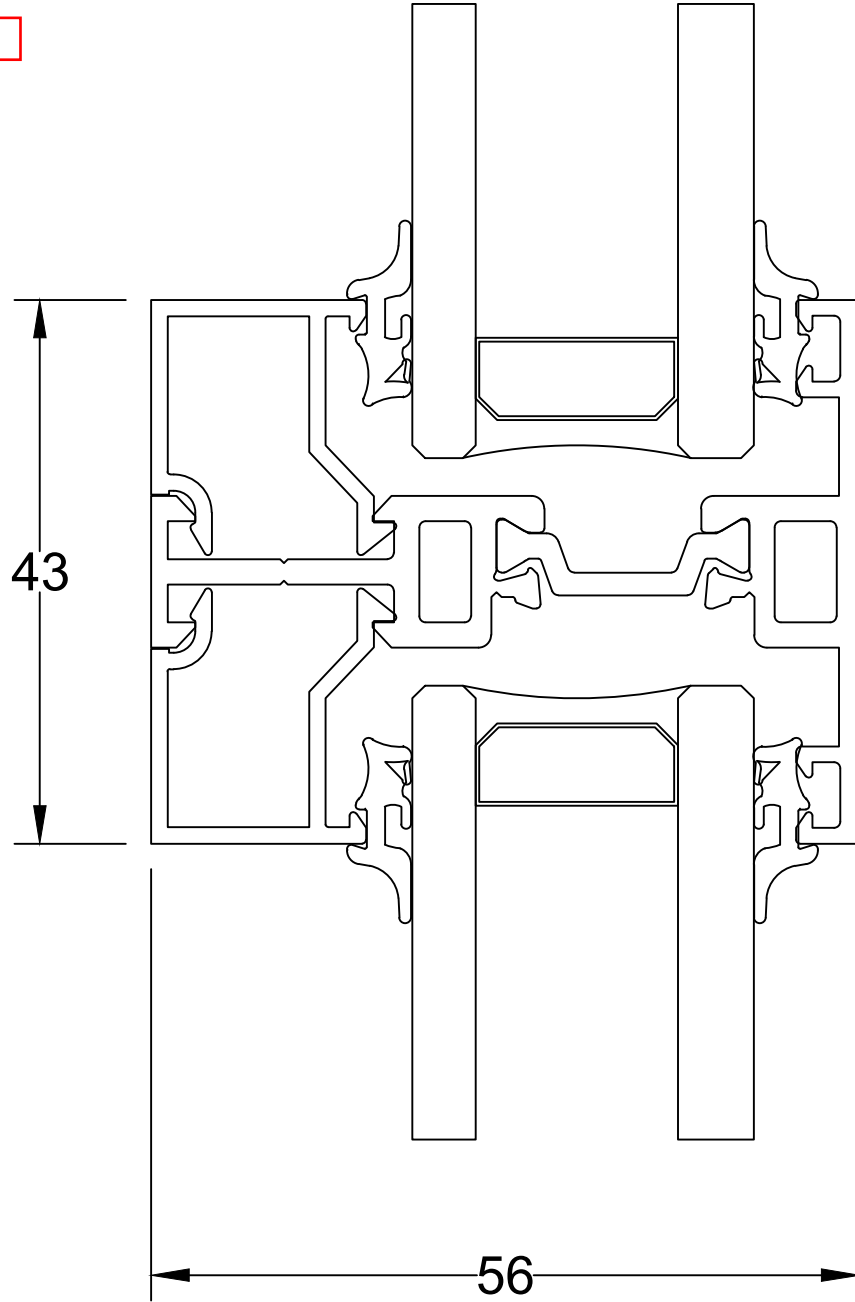

Part #30

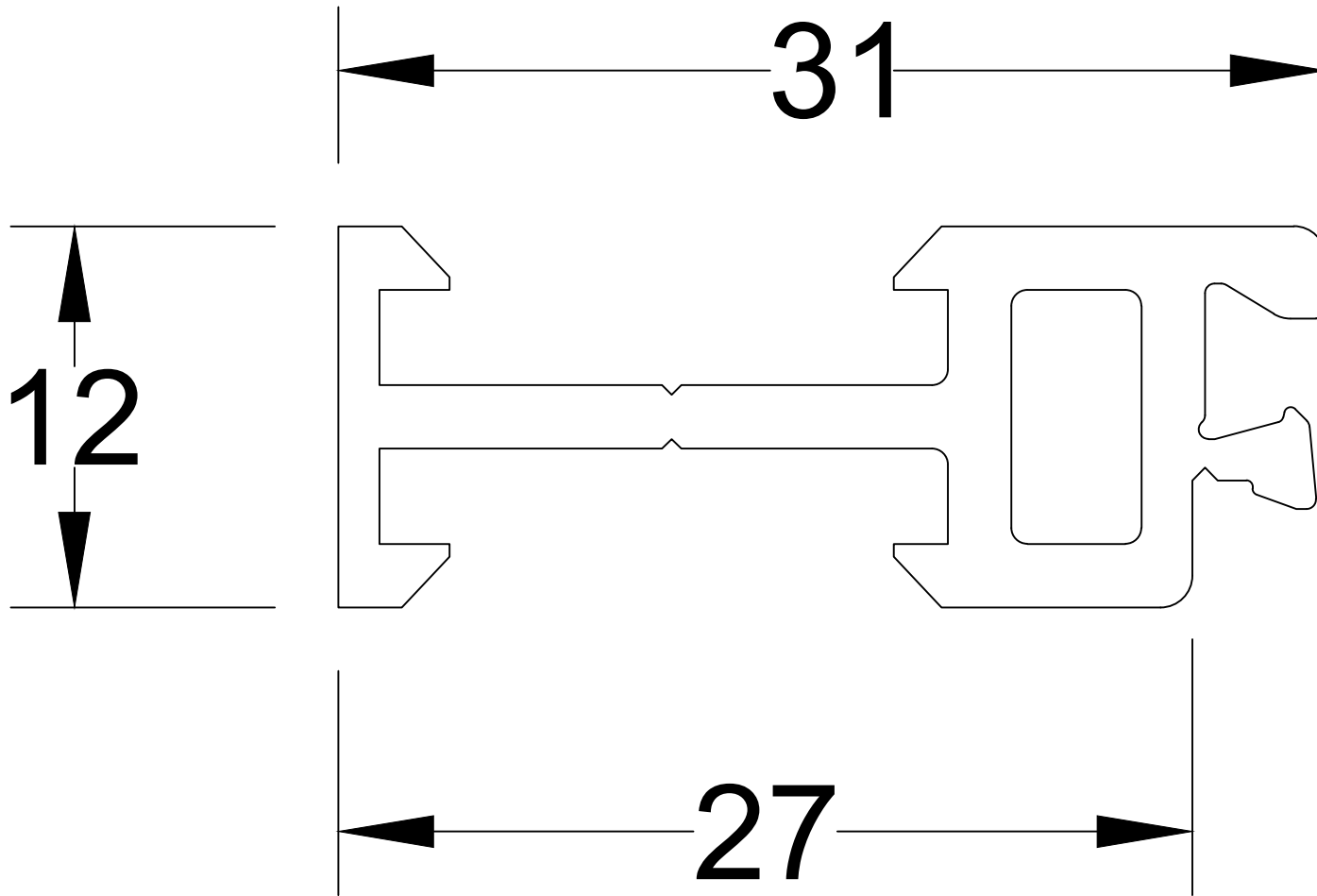

Part #31

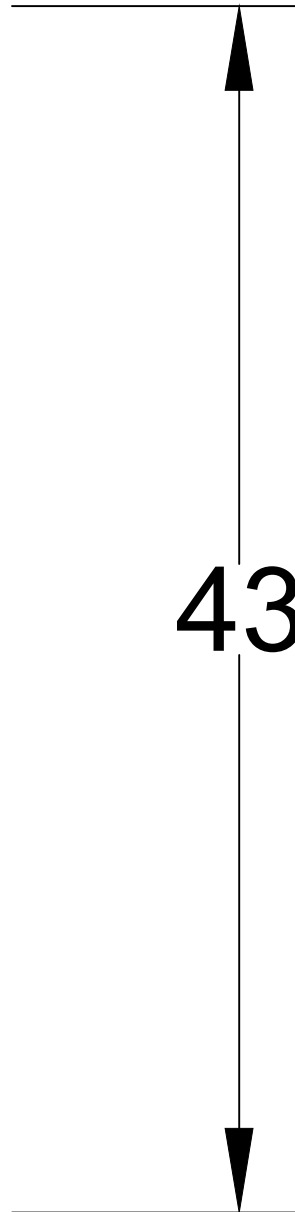
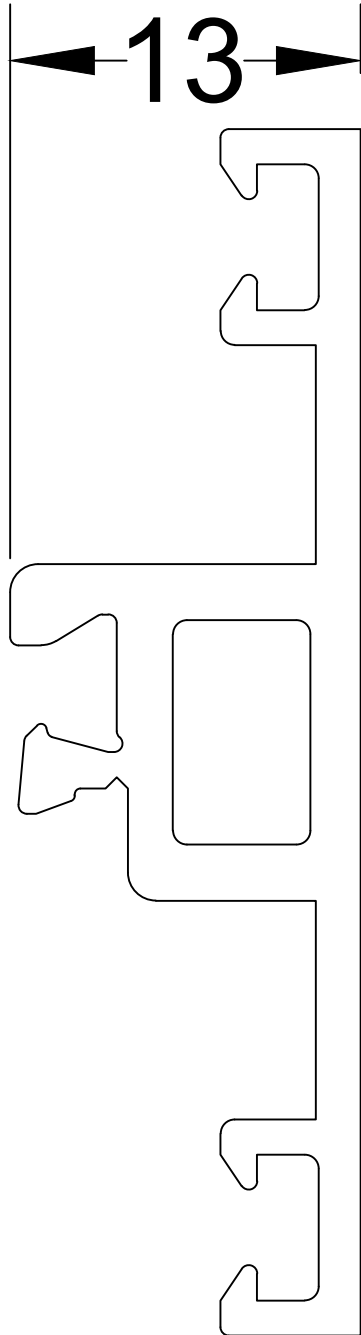

Part #32

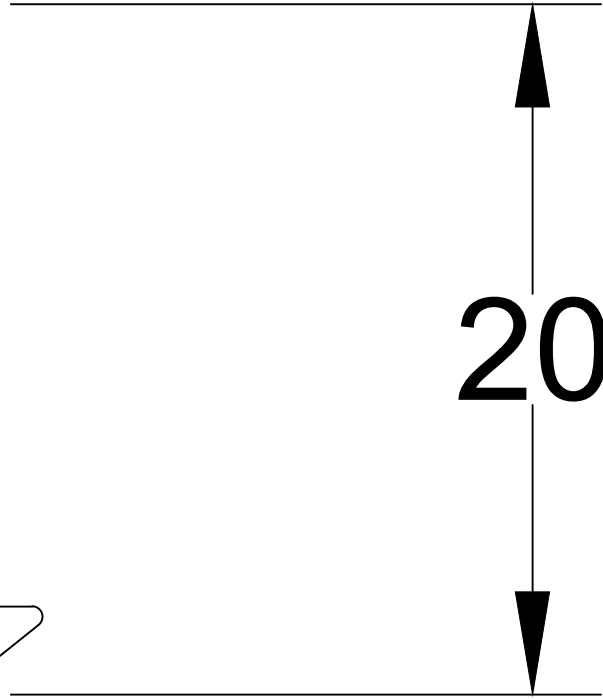
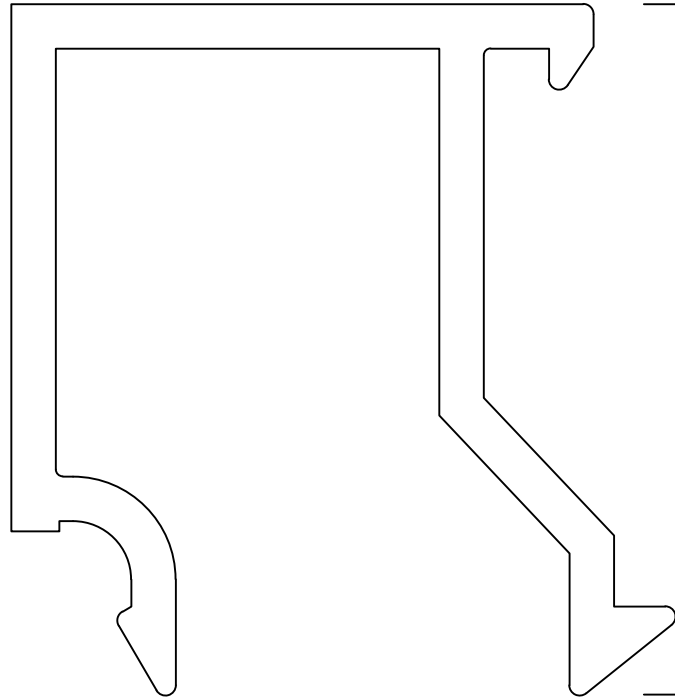
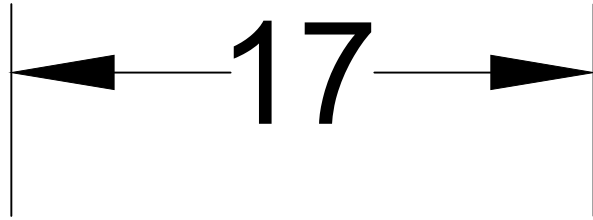

Part #33

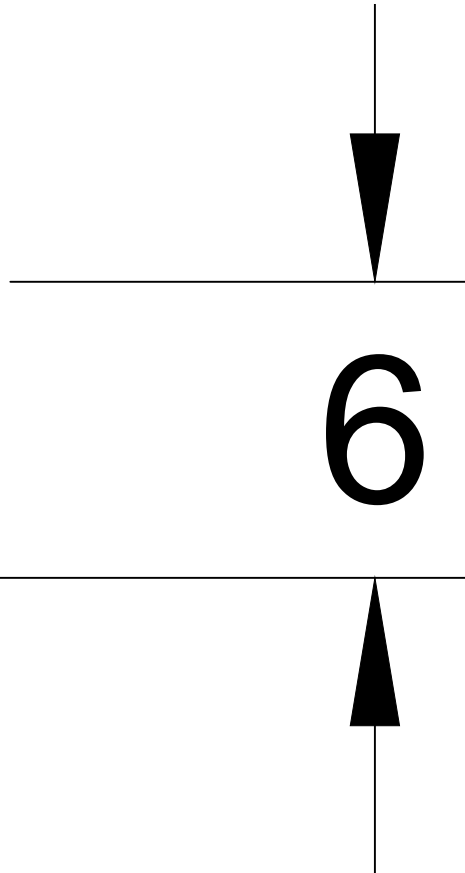
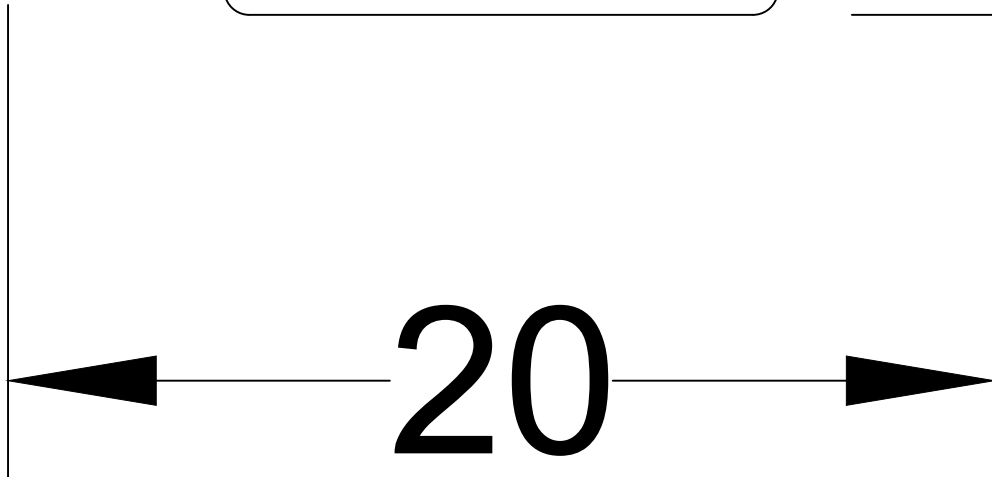
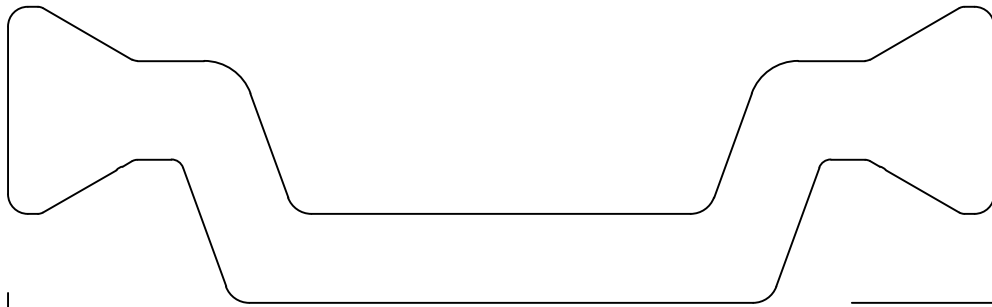

 Total Quality. Assured.	Report #:	K0461.01-301-45
	Date:	09/04/19
	Verified by:	

Part #34

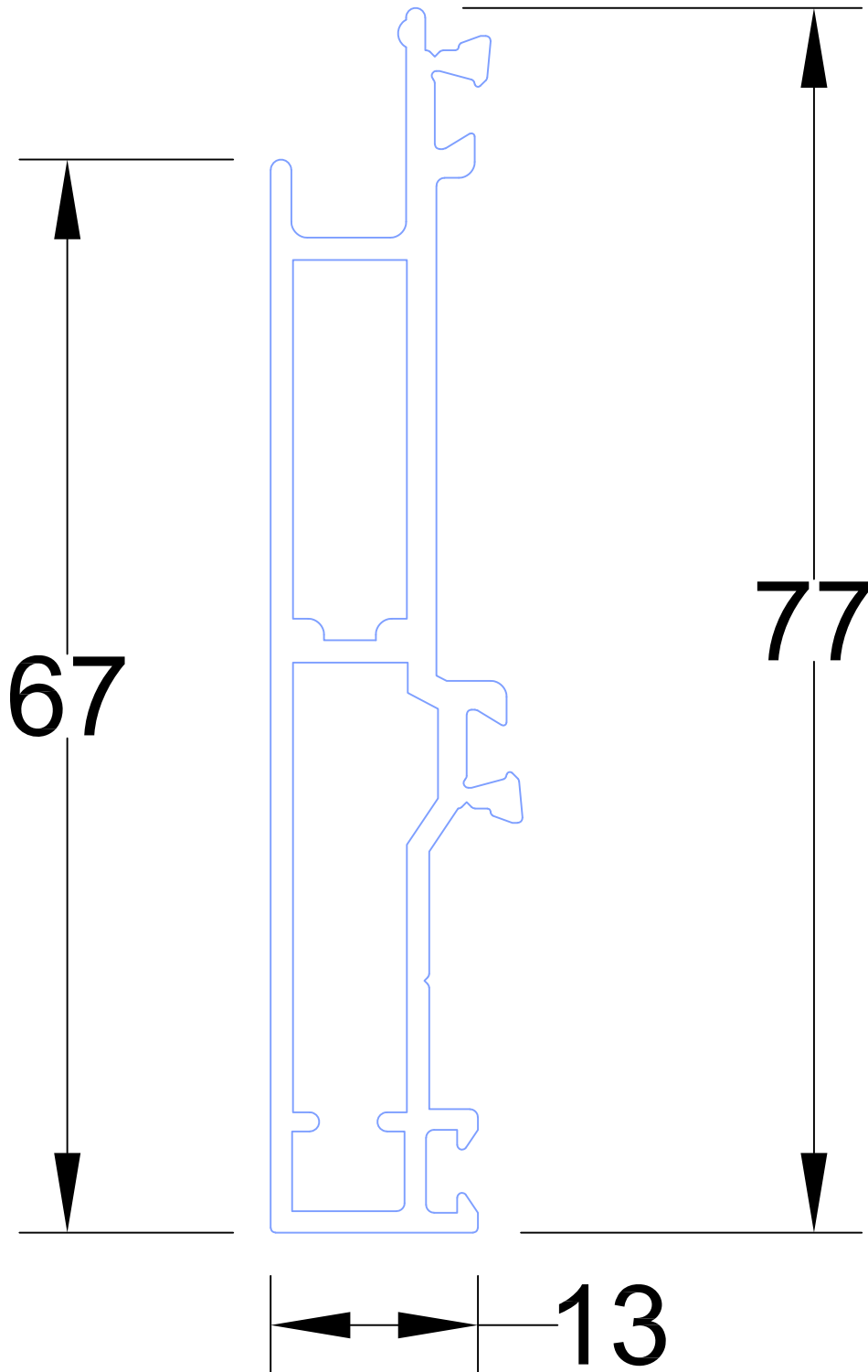

Part #35

intertek
Total Quality. Assured.

Report #:	K0461.01-301-45
Date:	05/20/20
Verified by:	

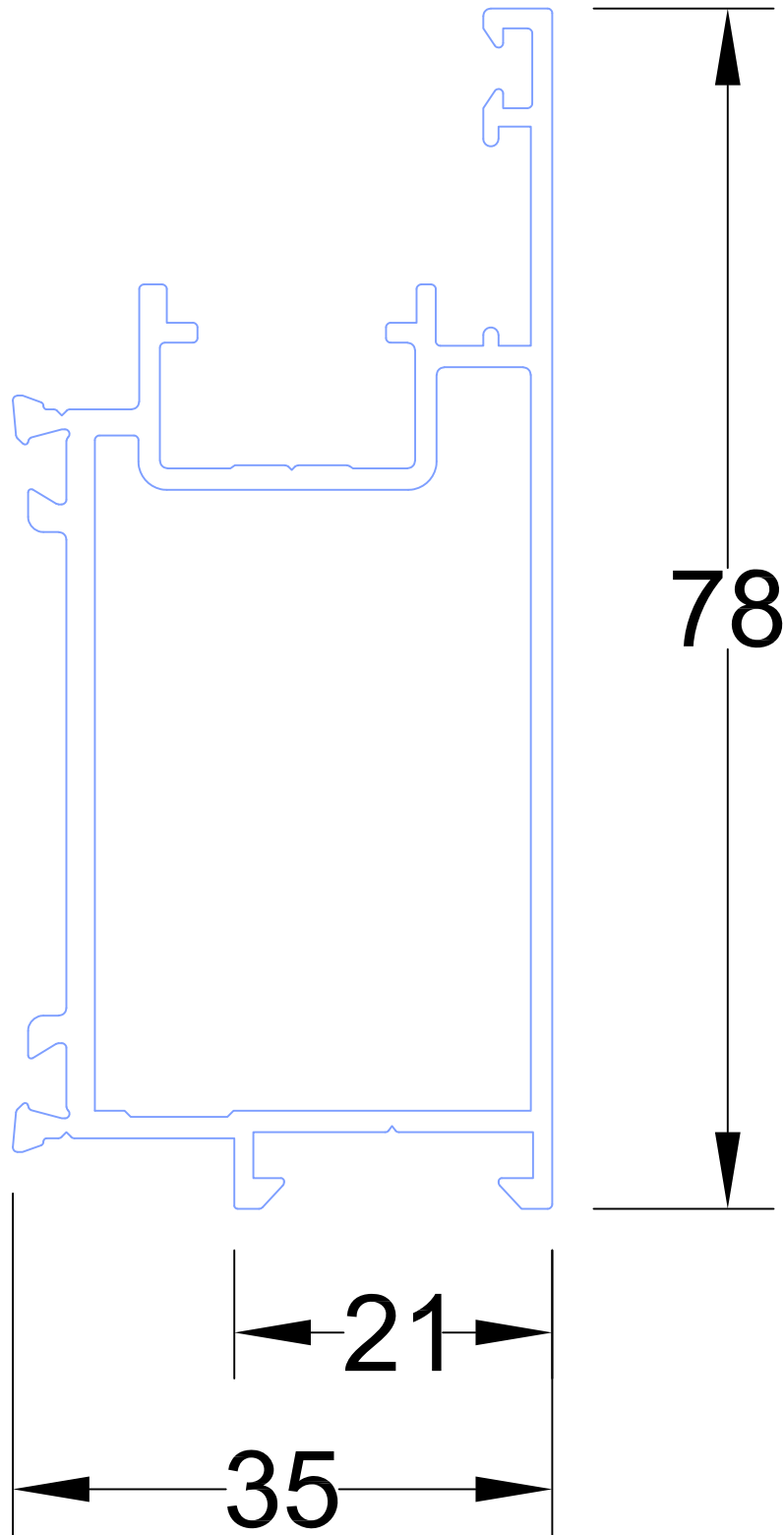

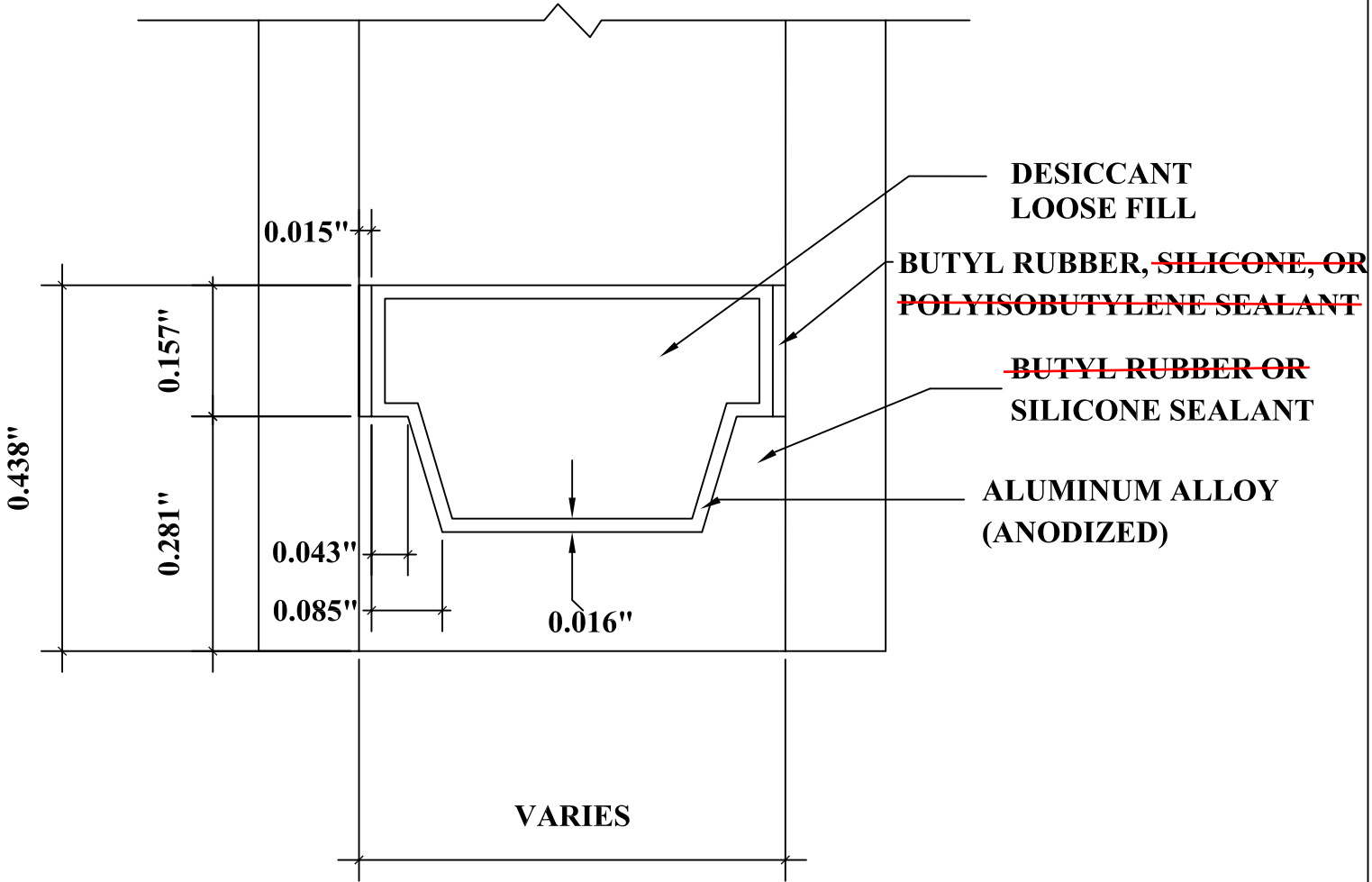

DETAIL FOR THERMAL MODELING OF
ALUMINUM SPACER (A1-D)

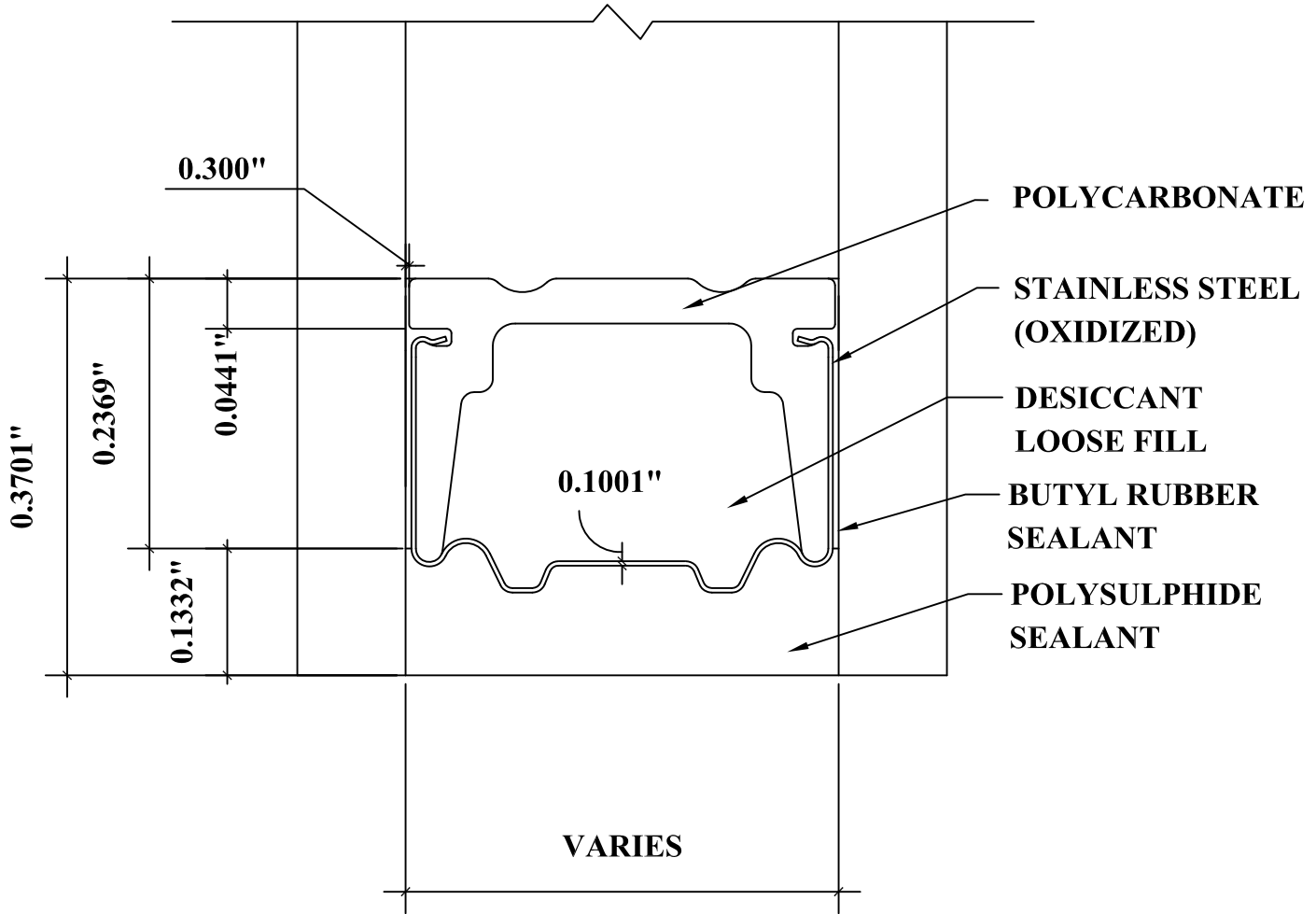

DETAIL FOR THERMAL MODELING OF
ROLLTECH CHROMATECH ULTRA SPACER (TS-D)

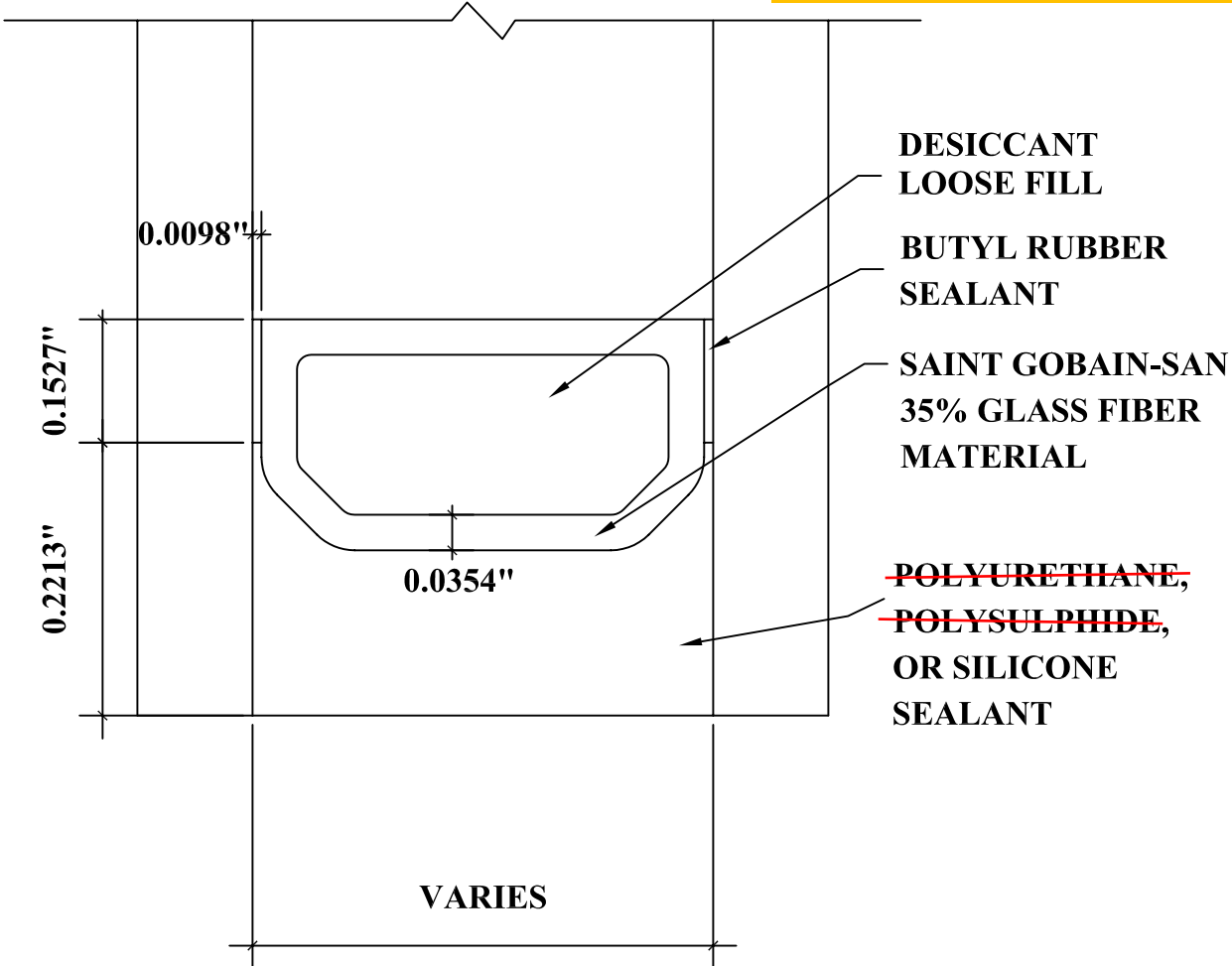

DETAIL FOR THERMAL MODELING OF
SAINT-GOBAIN SWISSPACER (TP-D)

TEST REPORT FOR NEON ENERGY USA INC.

Report No: K0461.02-301-45 R3

Date: 12/18/20

SECTION 8

REVISION LOG

REVISION #	DATE	PAGES	REVISION
.01R0	09/05/19	N/A	Original report issued to customer.
.01R1	09/23/19	N/A	Added options #853-856 to the report. Series/Model name updated.
.01R2	09/26/19	N/A	Added option #857-924 to the report.
.01R3	10/03/19	N/A	Added options #925-960 to the report.
.01R4	05/20/20	N/A	Intermittent component (Part #25) removed from models and drawing packet. Exterior boundary conditions updated. Modeling assumptions and drawing packet updated.
.01R5	05/29/20	N/A	SHGC tables updated.
.02R0	09/16/20	N/A	Option #961-1000 added to report.
.02R1	09/30/20	N/A	Gap updated for option #961-1000.
.02R2	12/18/20	N/A	Inswing top rail and jamb stiles updated. Options 961-1000 updated and recalculated.
.02R3	04/06/21	N/A	Spacer Secondary sealant corrected.