

NEON ENERGY COMPUTER SIMULATION REPORT

SCOPE OF WORK

ULTRA AWNING WINDOW - NFRC 100/200/500

REPORT NUMBER

P2842.01-116-45 R1

TEST DATE

11/23/22

ISSUE DATE

11/23/22

REVISION DATE

02/28/23

PAGES

58

DOCUMENT CONTROL NUMBER

RT-R-AMER-Test-4044 (04/11/22)

©2017 INTERTEK

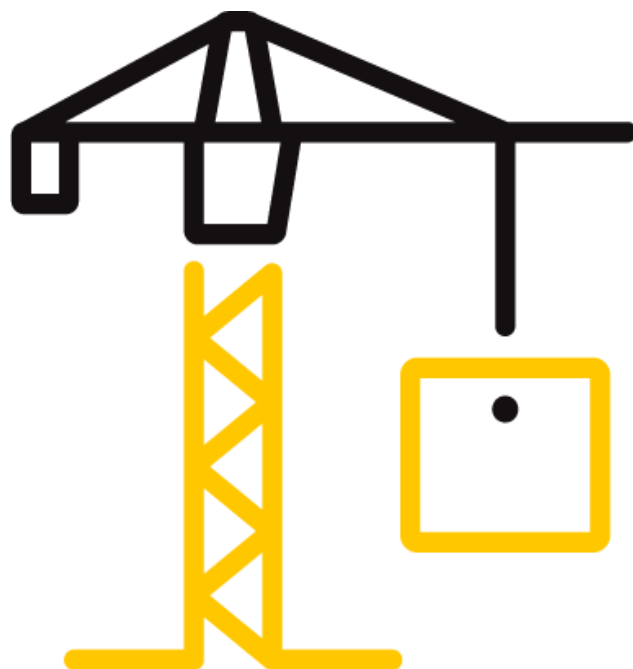

TEST REPORT FOR NEON ENERGY

Report No: P2842.01-116-45 R1

Date: 02/28/23

REPORT ISSUED TO

NEON ENERGY

23 Corporate Plaza

Suite 150

Newport Beach, California 92660

SECTION 1

SUMMARY

SERIES/MODEL: Ultra Awning Window

Architectural Testing, Inc. (an Intertek company) dba Intertek Building & Construction (B&C) was contracted to perform U-Factor, Solar Heat Gain Coefficient, Visible Transmittance and Condensation Resistance simulations in accordance with the National Fenestration Rating Council (NFRC).

This report does not constitute certification of this product nor an opinion or endorsement by this laboratory. Intertek B&C will service this report for the entire test record retention period. The test record retention period ends five years after the test date. Test records, such as detailed drawings, datasheets, representative samples of test specimens, or other pertinent project documentation, will be retained for the entire test record retention period.

FOR INTERTEK B&C:

COMPLETED BY: Megan M. Yingst
TITLE: Simulation Technician
SIGNATURE:
DATE: 02/28/23

REVIEWED BY: Eric S. Leitner
TITLE: Manager - Simulations
and Thermal Testing, SIRC
SIGNATURE:
DATE: 02/28/23

MMY:mmy

This report is for the exclusive use of Intertek's Client and is provided pursuant to the agreement between Intertek and its Client. Intertek's responsibility and liability are limited to the terms and conditions of the agreement. Intertek assumes no liability to any party, other than to the Client in accordance with the agreement, for any loss, expense or damage occasioned by the use of this report. Only the Client is authorized to permit copying or distribution of this report and then only in its entirety. Any use of the Intertek name or one of its marks for the sale or advertisement of the tested material, product or service must first be approved in writing by Intertek. The observations and test results in this report are relevant only to the sample(s) tested. This report by itself does not imply that the material, product, or service is or has ever been under an Intertek certification program.

TEST REPORT FOR NEON ENERGY

Report No: P2842.01-116-45 R1

Date: 02/28/23

SECTION 2

TEST METHODS

The products were evaluated in accordance with the following:

ANSI/NFRC 100-2020, Procedure for Determining Fenestration Product U-Factors

ANSI/NFRC 200-2020, Procedure for Determining Fenestration Product Solar Heat Gain Coefficient and Visible Transmittance at Normal Incidence

NFRC 500-2017, Procedure for Determining Fenestration Product Condensation Resistance Values

**Condensation Resistance results obtained from this procedure are for controlled laboratory conditions and do not include the effects of air movement through the specimen, solar radiation, and the thermal bridging that may occur due to the specific design and construction of the fenestration system opening.*

Ratings values included in this report are for submittals to an NFRC-licensed IA and are not meant to be used directly for labeling purposes. Only those values identified on a valid Certificate of Authorization (CA) by an NFRC accredited Inspection Agency (IA) are to be used for labeling purposes. The ratings values were rounded in accordance with NFRC 601, NFRC Unit and Measurement Policy.

Intertek B&C is an NFRC accredited simulation laboratory and all simulations were conducted in full compliance with NFRC approved procedures and specifications. The values included in this report are not considered in compliance with ANSI/NFRC 100, ANSI/NFRC 200, and/or NFRC 500 unless the associated validation test requirements have been satisfied, as applicable.

TEST REPORT FOR NEON ENERGY

Report No: P2842.01-116-45 R1

Date: 02/28/23

SECTION 3

TEST PROCEDURE

The total product, including specific frame, spacer, and glass details, was modeled using NFRC approved software.

FRAME AND EDGE MODELING	THERM 7.4.4
CENTER-OF-GLASS MODELING	WINDOW 7.4.14
TOTAL PRODUCT CALCULATIONS	WINDOW 7.4.14
SPECTRAL DATA LIBRARY	IGDB 90.0

Modeling Assumptions / Technical Interpretations

Any modeling assumptions and technical interpretations required to model this product are listed below.

- 1) To prevent air infiltration, tape was applied to all interior sash crack locations.
- 2) TVO-921, TVO-922 and TVO-927 frame options were grouped per ANSI/NFRC 100-2020, Section 4.2.1.H.ii. TVO-927 is the group leader.
- 3) TVO-901 and TVO-911 sash options were grouped per ANSI/NFRC 100-2020, Section 4.2.1.I.v. TVO-911 is the group leader.
- 4) The anodized and painted aluminum finishes were grouped per ANSI/NFRC 100-2020, Section 4.2.1.L. The painted finish is the group leader.

SECTION 4

SIMULATION SPECIMEN DESCRIPTION

SERIES/MODEL	Ultra Awning Window
PRODUCT TYPE	Projected (Awning)
FRAME MATERIAL	AT - Aluminum w/ Thermal Breaks - All Members
SASH MATERIAL	AT - Aluminum w/ Thermal Breaks - All Members
STANDARD SIZE	1500mm x 600mm

TEST REPORT FOR NEON ENERGY

Report No: P2842.01-116-45 R1

Date: 02/28/23

SECTION 4 (Continued)

SIMULATION SPECIMEN DESCRIPTION

SPACER OPTIONS			
TYPE	PRIMARY SEAL	SECONDARY SEAL	CODE
Aluminum Spacer	Butyl Rubber	Butyl Rubber	A1-D
Thermix TX.N Plus Spacer	Butyl Rubber	Silicone	TS-D

GRID OPTIONS		
GRID SIZE	GRID TYPE	GRID PATTERN
None	-	-

REINFORCEMENT OPTIONS	
LOCATION	MATERIAL
None	-

GAS FILLING TECHNIQUE	
FILL TYPE	METHOD
90% Argon	Two-probe with concentration sensor

EDGE-OF-GLASS CONSTRUCTION	
INTERIOR CONDITION	EPDM gasket between glass and glazing bead
EXTERIOR CONDITION	EPDM gasket between glass and aluminum frame

WEATHERSTRIPPING		
TYPE	QUANTITY	LOCATION
EPDM Gasket	1 row	Frame Perimeter
EPDM Gasket	1 row	Sash Perimeter

FRAME/SASH MATERIALS FINISH	
INTERIOR	Aluminum - Painted or Anodized
EXTERIOR	Aluminum - Painted or Anodized

VALIDATION MATRIX*	
PRODUCT LINE	REPORT NUMBER
Ultra Outswing Casement Window	P2841.01-116-45
Ultra Awning Window	P2842.01-116-45
Ultra Bi-Fold / Outswing Door	P2839.01-116-45

*These products are part of a validation matrix. Only one is required for validation testing.

TEST REPORT FOR NEON ENERGY

Report No: P2842.01-116-45 R1

Date: 02/28/23

SECTION 5

SPECIALTY PRODUCTS TABLE

The specialty products method allows the manufacturer to determine the overall product SHGC and VT for any glazing option. The center of glass SHGC and/or VT must be determined using WINDOW 7.4.14. The method calculates overall product SHGC and VT indexed on center of glass properties. All values used in the calculations are truncated to six decimal place precision.

	No Dividers	Dividers < 1	Dividers > 1
SHGC0	0.010488	0.012445	0.014296
SHGC1	0.582026	0.524563	0.470219
VT0	0.000000	0.000000	0.000000
VT1	0.571538	0.512118	0.455923

$$SHGC = SHGC0 + SHGCc (SHGC1 - SHGC0)$$

$$VT = VT0 + VTc (VT1 - VT0)$$

TEST REPORT FOR NEON ENERGY

Report No: P2842.01-116-45 R1

Date: 02/28/23

SECTION 6

SIMULATION RESULTS

TOTAL PRODUCT CALCULATIONS (Ultra Awning Window)												
Option Number	Pane Thickness 1 (in)	Gap Width 1 (in)	Pane Thickness 2 (in)	Gap Width 2 (in)	Pane Thickness 3 (in)	Gap Width 3 (in)	Pane Thickness 4 (in)	Gap Fill	Low-e (Surface #)	Tint	Spacer	Grid Type
	U-Factor (Btu/Hr-Ft2-F)			Solar Heat Gain Coefficient (SHGC) Grids (None / <1 / >=1)				Visible Transmittance (VT) Grids (None / <1 / >=1)		Condensation Resistance (CR)		
1	SNX50/ARG90/CLR (6MM/5MM) - 27MM IG											
	0.230	0.630	0.191					ARG90	0.027(#2)	CL	A1-D	N
	U-Factor 0.41			SHGC(N) 0.14				VT(N) 0.28		CR 49		
2	SNX60/ARG90/CLR (6MM/5MM) - 27MM IG											
	0.230	0.630	0.191					ARG90	0.026(#2)	CL	A1-D	N
	U-Factor 0.41			SHGC(N) 0.16				VT(N) 0.34		CR 49		
3	SN4023/ARG90/CLR (6MM/5MM) - 27MM IG											
	0.230	0.630	0.191					ARG90	0.026(#2)	CL	A1-D	N
	U-Factor 0.41			SHGC(N) 0.13				VT(N) 0.23		CR 49		
4	SN7037/ARG90/CLR (6MM/6MM) - 28MM IG											
	0.230	0.630	0.230					ARG90	0.022(#2)	CL	A1-D	N
	U-Factor 0.41			SHGC(N) 0.21				VT(N) 0.40		CR 48		
5	SN7037/ARG90/CLR (6MM/5MM) - 27MM IG											
	0.230	0.630	0.191					ARG90	0.022(#2)	CL	A1-D	N
	U-Factor 0.41			SHGC(N) 0.21				VT(N) 0.40		CR 49		
6	SNX50/ARG90/CG-Dry (6MM/5MM) - 27MM IG											
	0.230	0.630	0.191					ARG90	0.027(#2) / 0.200(#4)	CL	TS-D	N
	U-Factor 0.37			SHGC(N) 0.13				VT(N) 0.27		CR 49		
7	SNX50/ARG90/CG-Premium2T (6MM/6MM) - 28MM IG											
	0.230	0.630	0.230					ARG90	0.027(#2) / 0.041(#3)	CL	TS-D	N
	U-Factor 0.39			SHGC(N) 0.14				VT(N) 0.28		CR 51		
8	SNX60/ARG90/CG-Dry (6MM/5MM) - 27MM IG											
	0.230	0.630	0.191					ARG90	0.026(#2) / 0.200(#4)	CL	TS-D	N
	U-Factor 0.37			SHGC(N) 0.16				VT(N) 0.33		CR 49		
9	SNX60/ARG90/CG-Premium2T (6MM/6MM) - 28MM IG											
	0.230	0.630	0.230					ARG90	0.026(#2) / 0.041(#3)	CL	TS-D	N
	U-Factor 0.39			SHGC(N) 0.16				VT(N) 0.33		CR 51		
10	SN4023/ARG90/CG-Dry (6MM/5MM) - 27MM IG											
	0.230	0.630	0.191					ARG90	0.026(#2) / 0.200(#4)	CL	TS-D	N
	U-Factor 0.37			SHGC(N) 0.13				VT(N) 0.22		CR 49		

TEST REPORT FOR NEON ENERGY

Report No: P2842.01-116-45 R1

Date: 02/28/23

SECTION 6 (Continued)

SIMULATION RESULTS

TOTAL PRODUCT CALCULATIONS (Ultra Awning Window)												
Option Number	Pane Thickness 1 (in)	Gap Width 1 (in)	Pane Thickness 2 (in)	Gap Width 2 (in)	Pane Thickness 3 (in)	Gap Width 3 (in)	Pane Thickness 4 (in)	Gap Fill	Low-e (Surface #)	Tint	Spacer	Grid Type
	U-Factor (Btu/Hr-Ft2-F)			Solar Heat Gain Coefficient (SHGC) Grids (None / <1 / >=1)				Visible Transmittance (VT) Grids (None / <1 / >=1)		Condensation Resistance (CR)		
11	SN4023/ARG90/CG-Premium2T (6MM/6MM) - 28MM IG											
	0.230	0.630	0.230					ARG90	0.026(#2) / 0.041(#3)	CL	TS-D	N
	U-Factor 0.39			SHGC(N) 0.13				VT(N) 0.22		CR 51		
12	SN51/ARG90/CG-Dry (6MM/5MM) - 27MM IG											
	0.230	0.630	0.191					ARG90	0.026(#2) / 0.200(#4)	CL	TS-D	N
	U-Factor 0.37			SHGC(N) 0.15				VT(N) 0.28		CR 49		
13	SN51/ARG90/CG-Premium2T (6MM/6MM) - 28MM IG											
	0.230	0.630	0.230					ARG90	0.026(#2) / 0.041(#3)	CL	TS-D	N
	U-Factor 0.39			SHGC(N) 0.15				VT(N) 0.28		CR 51		
14	SN7037/ARG90/CG-Dry (6MM/6MM) - 28MM IG											
	0.230	0.630	0.230					ARG90	0.022(#2) / 0.200(#4)	CL	TS-D	N
	U-Factor 0.37			SHGC(N) 0.20				VT(N) 0.39		CR 49		
15	SN7037/ARG90/CG-Premium2T (6MM/6MM) - 28MM IG											
	0.230	0.630	0.230					ARG90	0.022(#2) / 0.041(#3)	CL	TS-D	N
	U-Factor 0.39			SHGC(N) 0.21				VT(N) 0.39		CR 51		
16	SN7037/ARG90/CG-Dry (6MM/5MM) - 27MM IG											
	0.230	0.630	0.191					ARG90	0.022(#2) / 0.200(#4)	CL	TS-D	N
	U-Factor 0.37			SHGC(N) 0.20				VT(N) 0.39		CR 49		
17	SN7037/ARG90/CG-Premium2T (6MM/4MM) - 26MM IG											
	0.230	0.630	0.151					ARG90	0.022(#2) / 0.041(#3)	CL	TS-D	N
	U-Factor 0.39			SHGC(N) 0.21				VT(N) 0.39		CR 51		
18	SN7037/ARG90/CLR/ARG90/CGPremium2T (6MM/5MM/6MM) - 39MM IG											
	0.230	0.394	0.191	0.472	0.230			ARG90	0.022(#2) / 0.041(#5)	CL	TS-D	N
	U-Factor 0.32			SHGC(N) 0.19				VT(N) 0.36		CR 51		
19	SNX60/ARG90/CLR/ARG90/CGPremium2T (6MM/5MM/6MM) - 39MM IG											
	0.230	0.394	0.191	0.472	0.230			ARG90	0.026(#2) / 0.041(#5)	CL	TS-D	N
	U-Factor 0.32			SHGC(N) 0.15				VT(N) 0.30		CR 51		
20	SNX60/ARG90/CLR/ARG90/CGPremium2T (6MM/4MM/4MM) - 36MM IG											
	0.230	0.394	0.151	0.472	0.151			ARG90	0.026(#2) / 0.041(#5)	CL	TS-D	N
	U-Factor 0.32			SHGC(N) 0.15				VT(N) 0.31		CR 50		

TEST REPORT FOR NEON ENERGY

Report No: P2842.01-116-45 R1

Date: 02/28/23

SECTION 6 (Continued)

SIMULATION RESULTS

TOTAL PRODUCT CALCULATIONS (Ultra Awning Window)																	
Option Number	Pane Thickness 1 (in)	Gap Width 1 (in)	Pane Thickness 2 (in)	Gap Width 2 (in)	Pane Thickness 3 (in)	Gap Width 3 (in)	Pane Thickness 4 (in)	Gap Fill	Low-e (Surface #)	Tint	Spacer	Grid Type					
	U-Factor (Btu/Hr-Ft ² -F)		Solar Heat Gain Coefficient (SHGC) Grids (None / <1 / >=1)				Visible Transmittance (VT) Grids (None / <1 / >=1)		Condensation Resistance (CR)								
21	SN7037/ARG90/CLR-LAMI (6MM/5MM 0,38PVB 5MM) - 32MM IG																
	0.230	0.630	0.379					ARG90	0.022(#2)	CL	TS-D	N					
	U-Factor		0.40		SHGC(N)			0.20		VT(N)		0.39		CR		50	



Total Quality. Assured.

130 Derry Court
York, Pennsylvania 17406

Telephone: 717-764-7700
Facsimile: 717-764-4129
www.intertek.com/building

TEST REPORT FOR NEON ENERGY

Report No: P2842.01-116-45 R1

Date: 02/28/23

SECTION 7

DRAWINGS / BILL OF MATERIALS

The drawings which follow have been reviewed by Intertek B&C and are representative of the simulation results reported herein. Any deviations are documented herein or on the drawings.

Awning Window

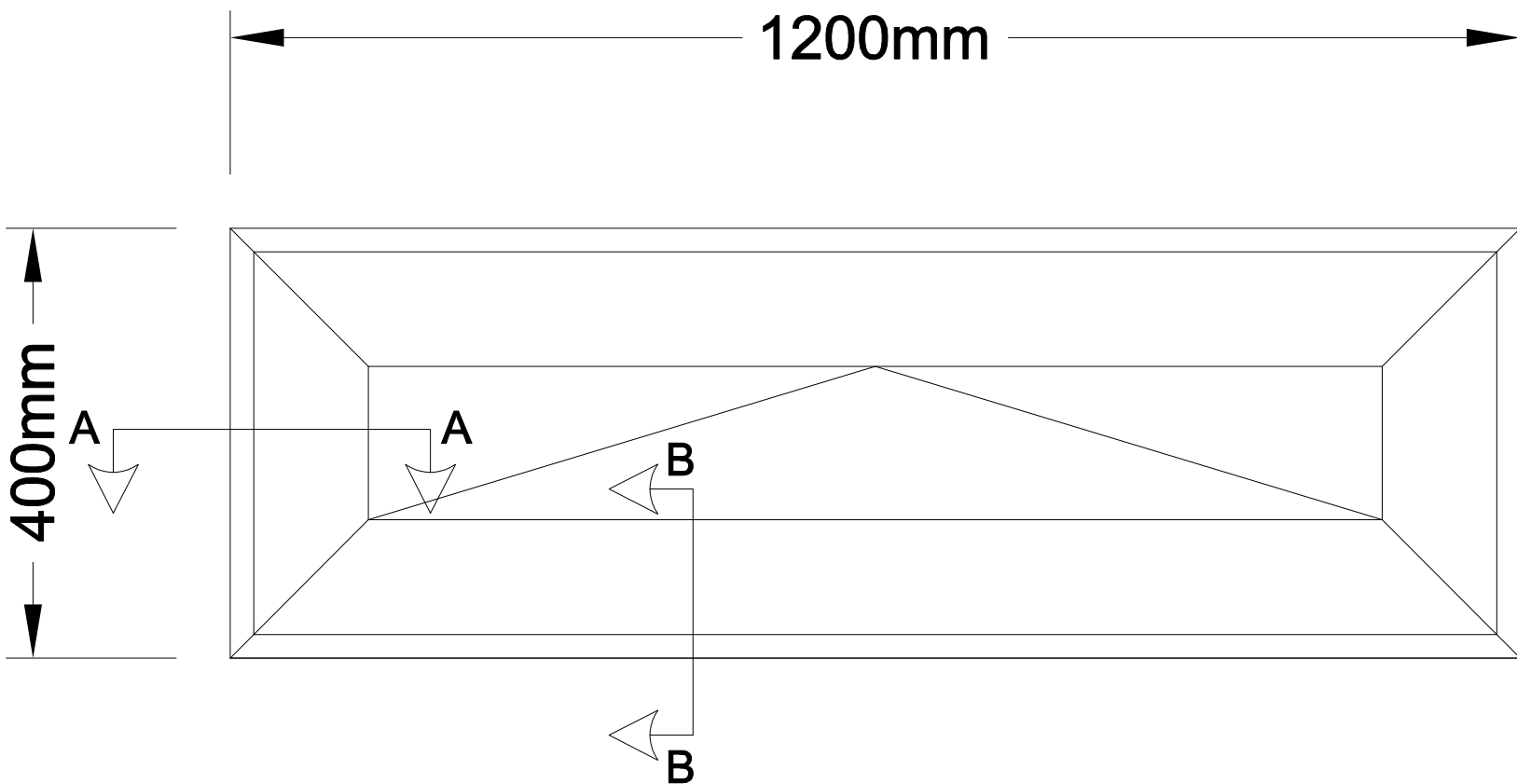

Section A-A, B-B Frame TVO-921 Sash TVO-901



Report #: P2842-116-45

Date: 11/23/2022

Verified by: *Megan M. Young*

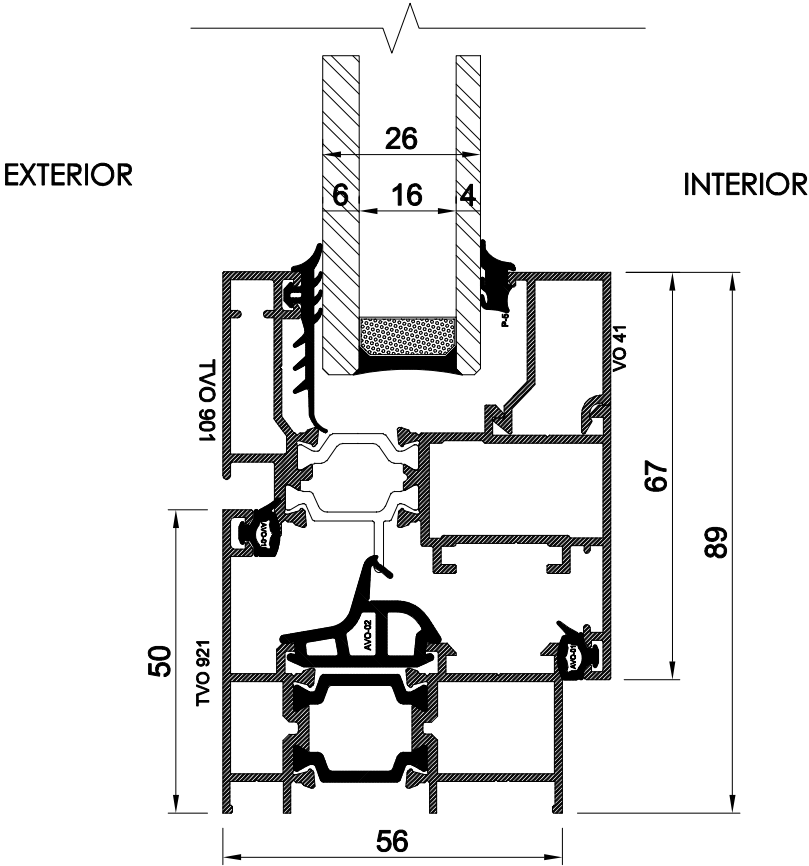

Section A-A, B-B Frame TVO-921 Sash TVO-901



Report #: P2842-116-45

Date: 11/23/2022

Verified by: *Megan M. Young*

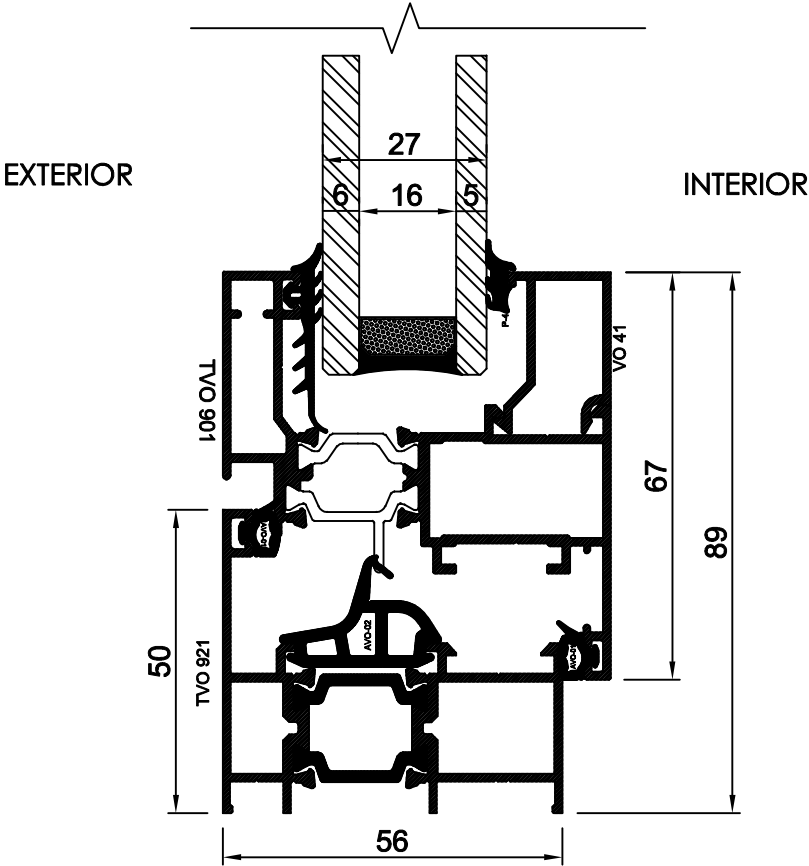

Section A-A, B-B Frame TVO-921 Sash TVO-901



Report #: P2842-116-45

Date: 11/23/2022

Verified by: *Megan M. Young*

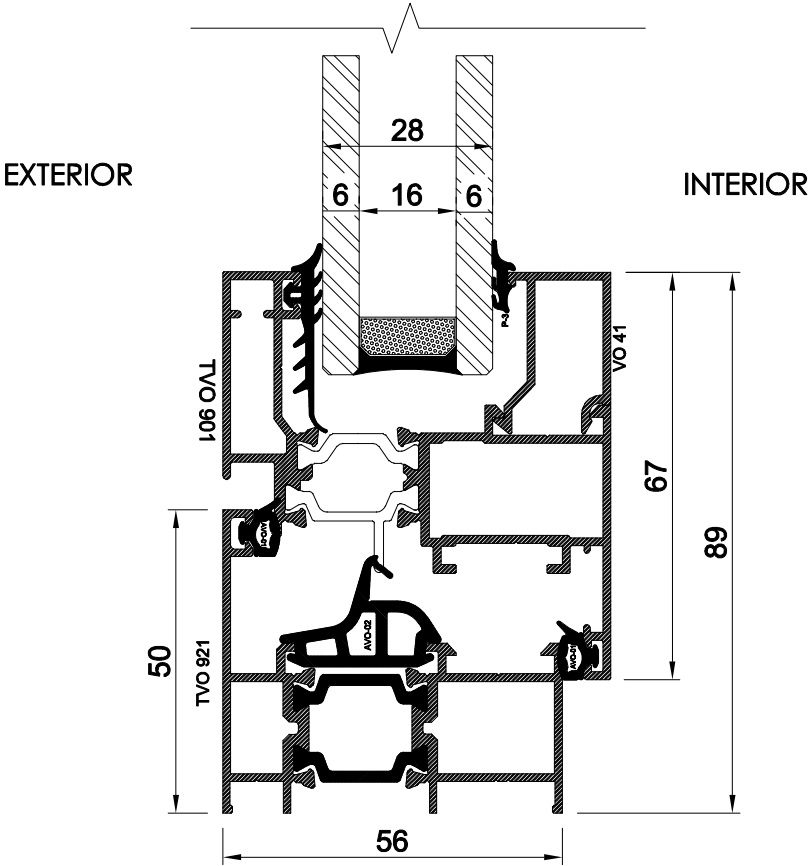

Section A-A, B-B Frame TVO-921 Sash TVO-901



Report #: P2842-116-45

Date: 11/23/2022

Verified by: *Megan M. Young*

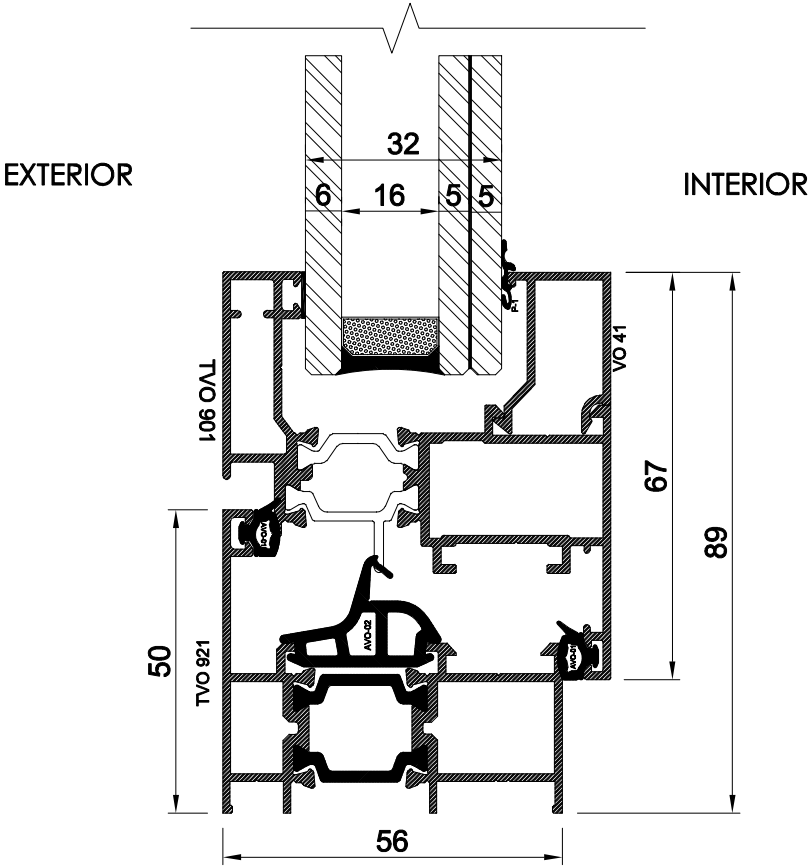

Section A-A, B-B Frame TVO-921 Sash TVO-901



Report #: P2842-116-45

Date: 11/23/2022

Verified by: *Megan M. Young*

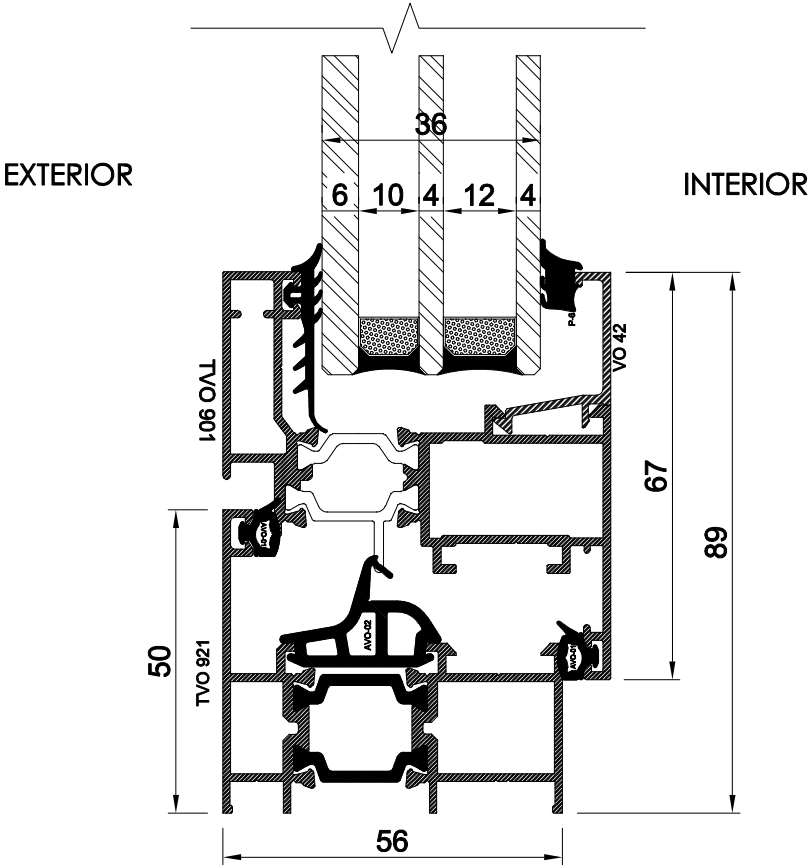

Section A-A, B-B Frame TVO-921 Sash TVO-901



Report #: P2842-116-45

Date: 11/23/2022

Verified by: *Megan M. Young*

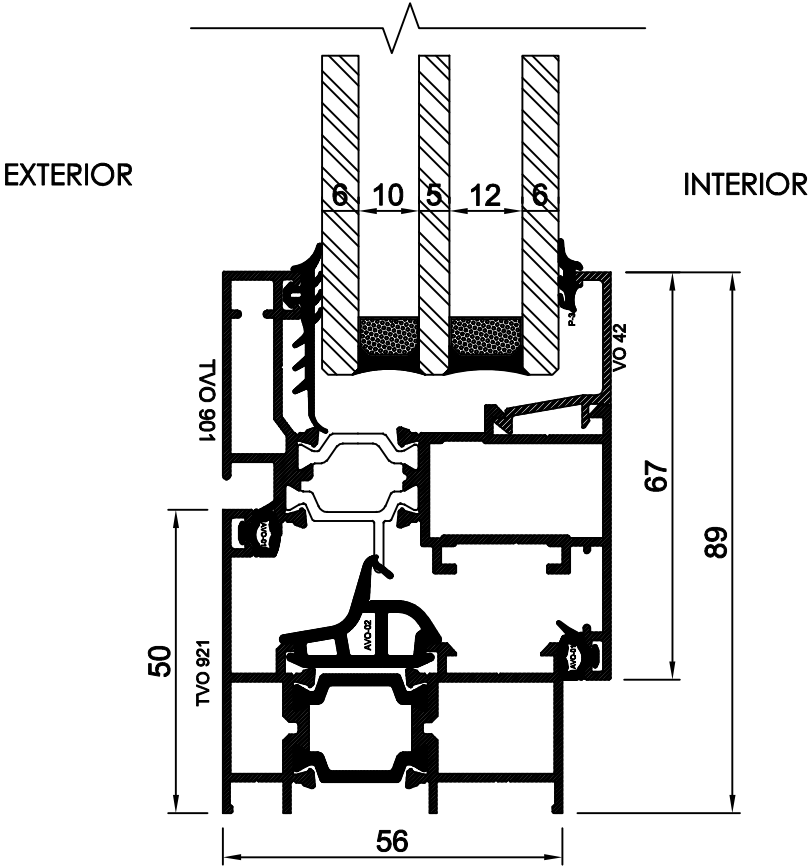

Section A-A, B-B Frame TVO-921 Sash TVO-911



Report #: P2842-116-45

Date: 11/23/2022

Verified by: *Megan M. Young*

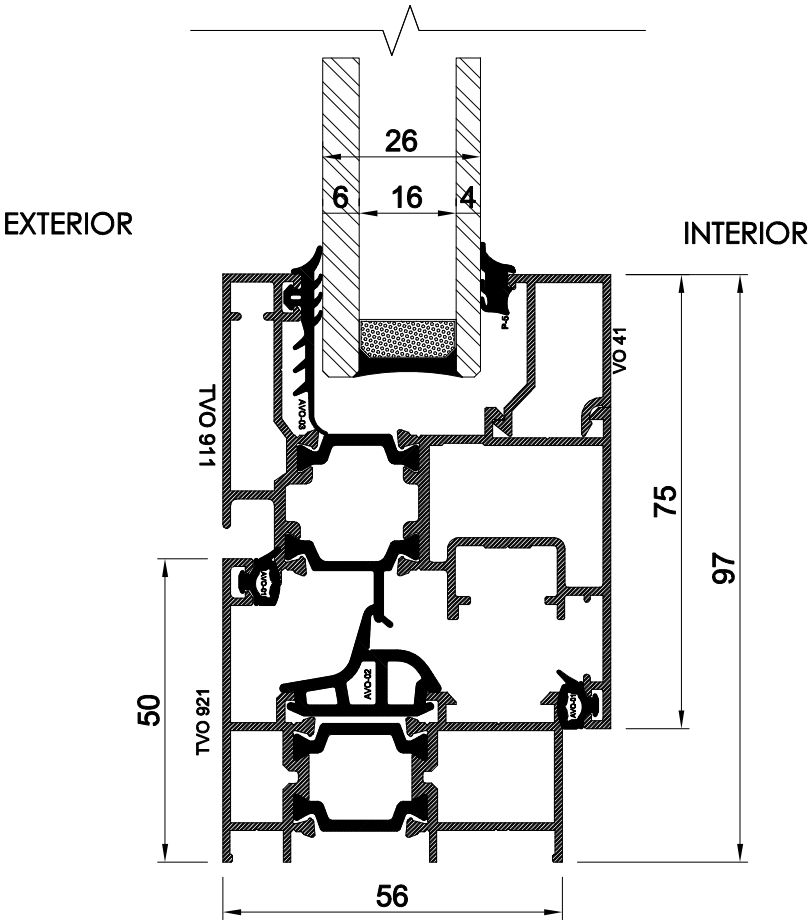

Section A-A, B-B Frame TVO-921 Sash TVO-911



Report #: P2842-116-45

Date: 11/23/2022

Verified by: *Megan M. Young*

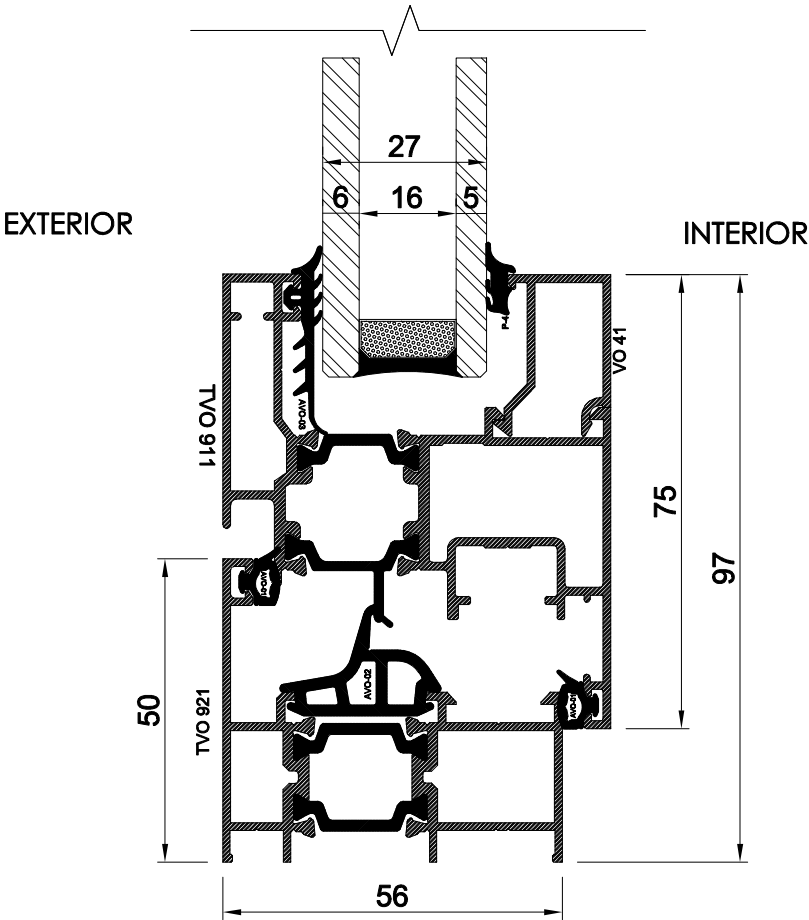

Section A-A, B-B Frame TVO-921 Sash TVO-911



Report #: P2842-116-45

Date: 11/23/2022

Verified by: *Megan M. Young*

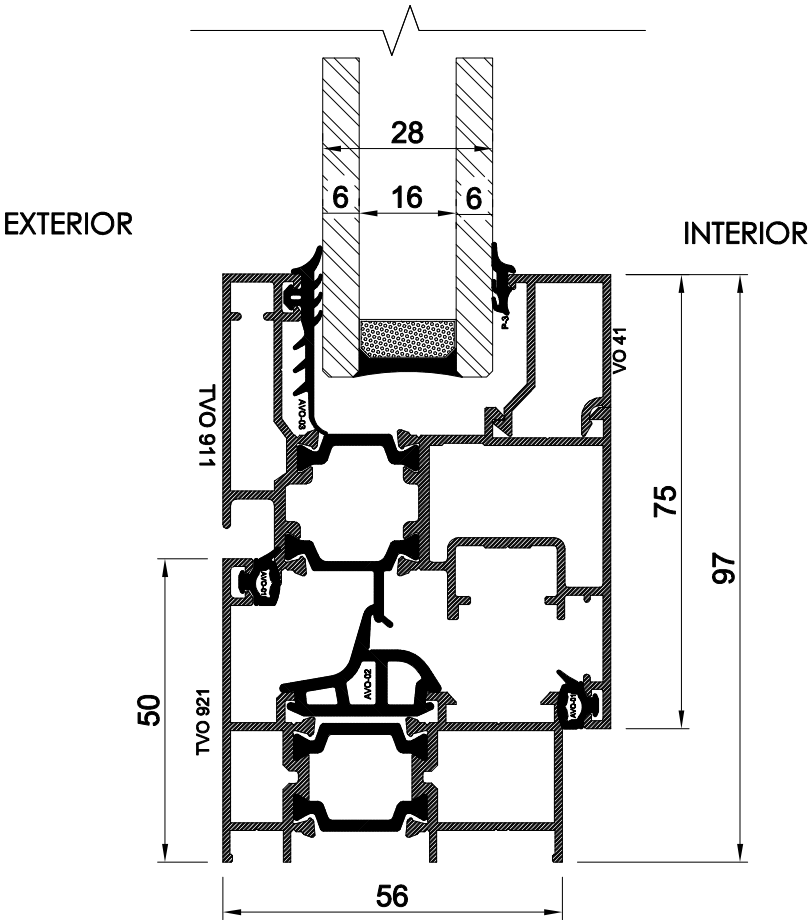

Section A-A, B-B Frame TVO-921 Sash TVO-911



Report #: P2842-116-45

Date: 11/23/2022

Verified by: *Megan M. Young*

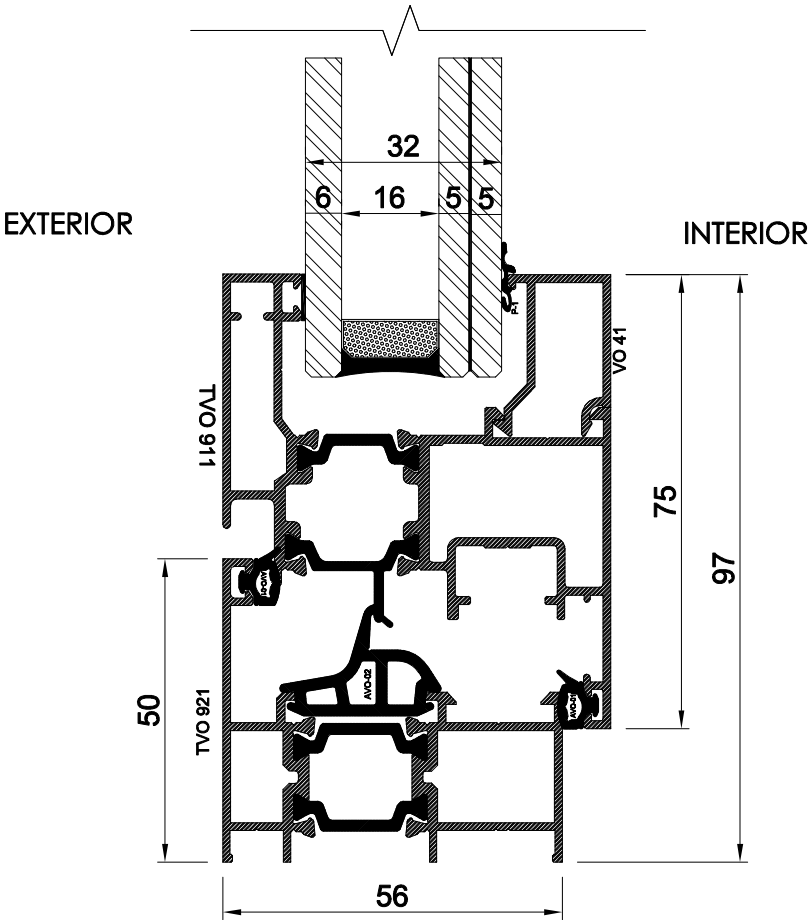

Section A-A, B-B Frame TVO-921 Sash TVO-911



Report #: P2842-116-45

Date: 11/23/2022

Verified by: *Megan M. Young*

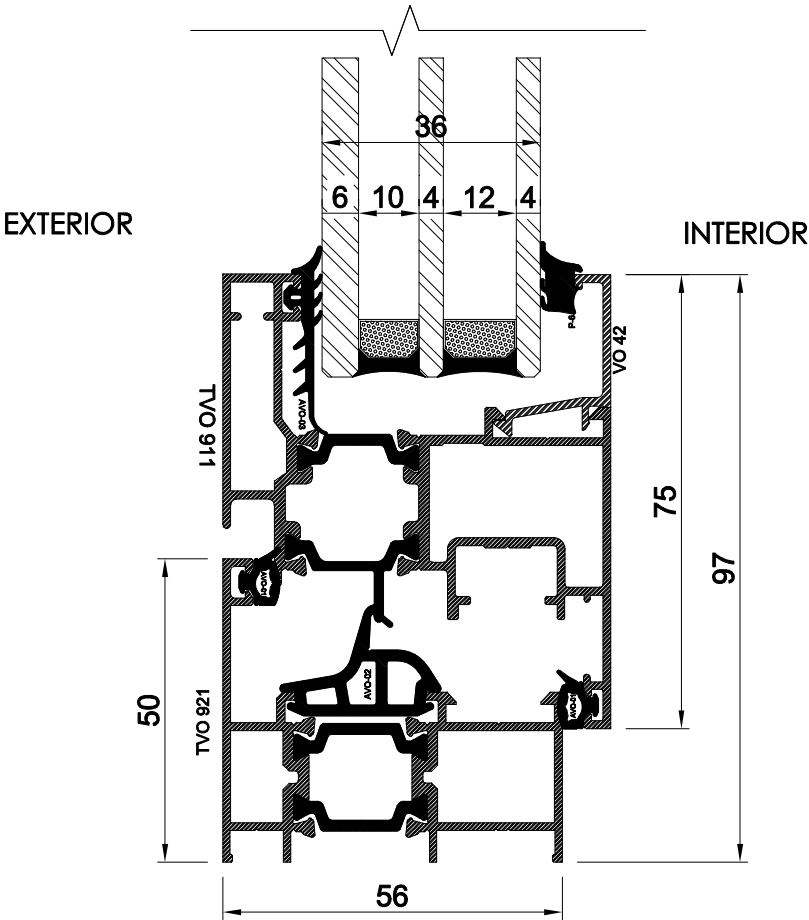

Section A-A, B-B
Frame TVO-921
Sash TVO-911

Specimen

	Report #: P2842-116-45
	Date: 11/23/2022
	Verified by: <i>Megan M. Young</i>

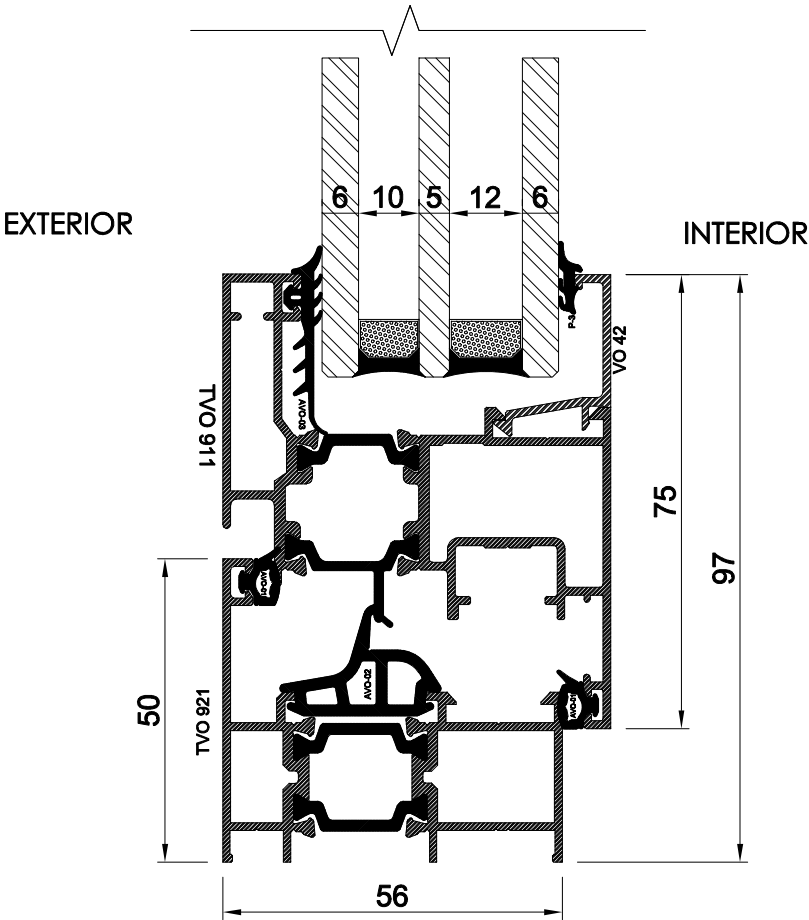

Section A-A, B-B Frame TVO-922 Sash TVO-901



Report #: P2842-116-45

Date: 11/23/2022

Verified by: *Megan M. Young*

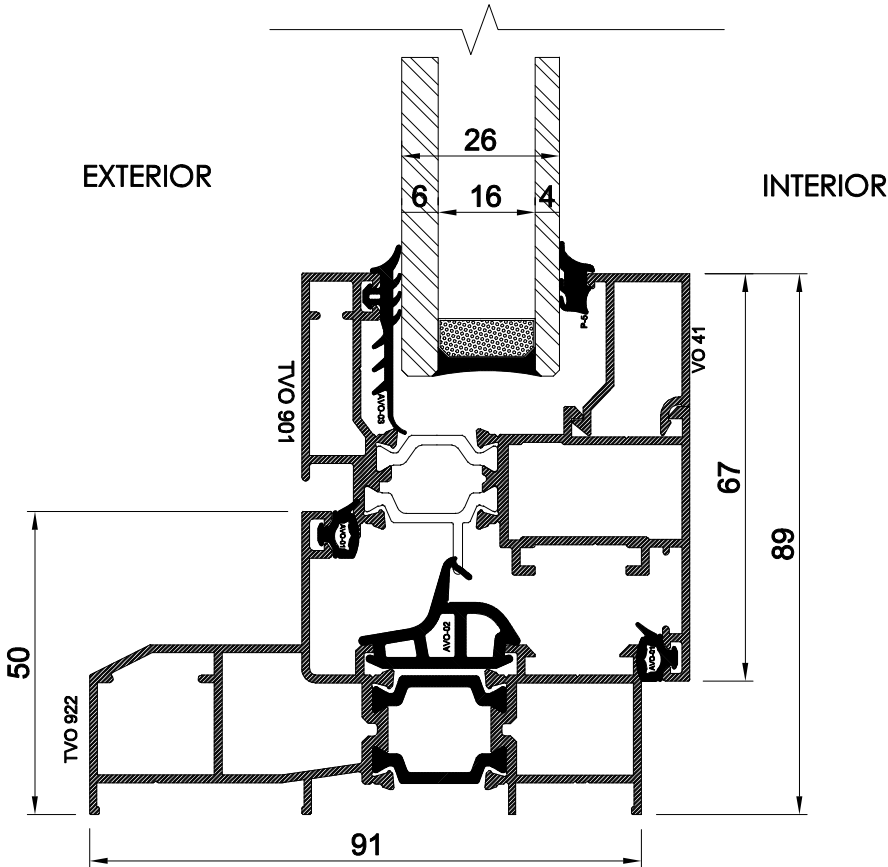

Section A-A, B-B Frame TVO-922 Sash TVO-901



Report #: P2842-116-45

Date: 11/23/2022

Verified by: *Megan M. Young*

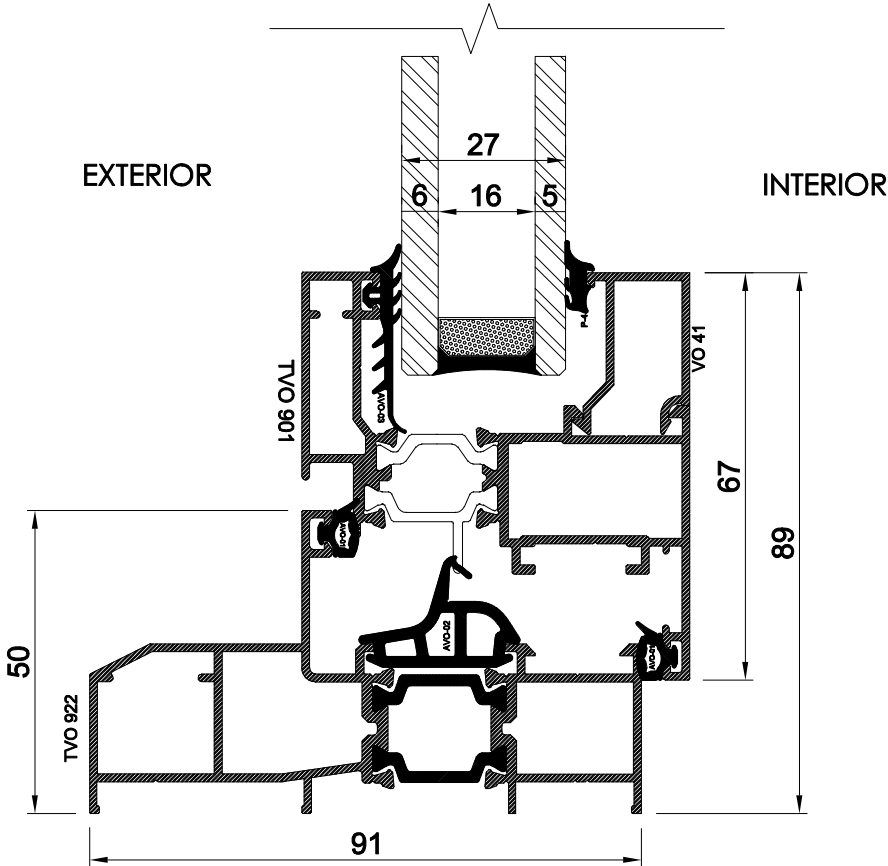

Section A-A, B-B Frame TVO-922 Sash TVO-901



Report #: P2842-116-45

Date: 11/23/2022

Verified by: *Megan M. Young*

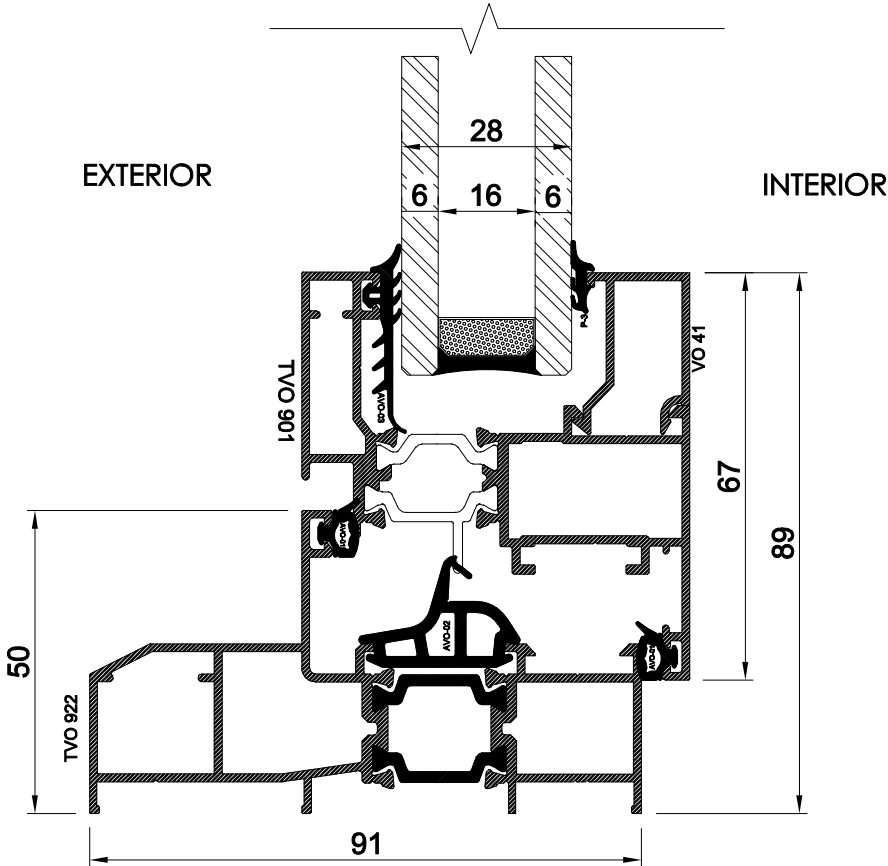

Section A-A, B-B Frame TVO-922 Sash TVO-901



Report #: P2842-116-45

Date: 11/23/2022

Verified by: *Megan M. Young*

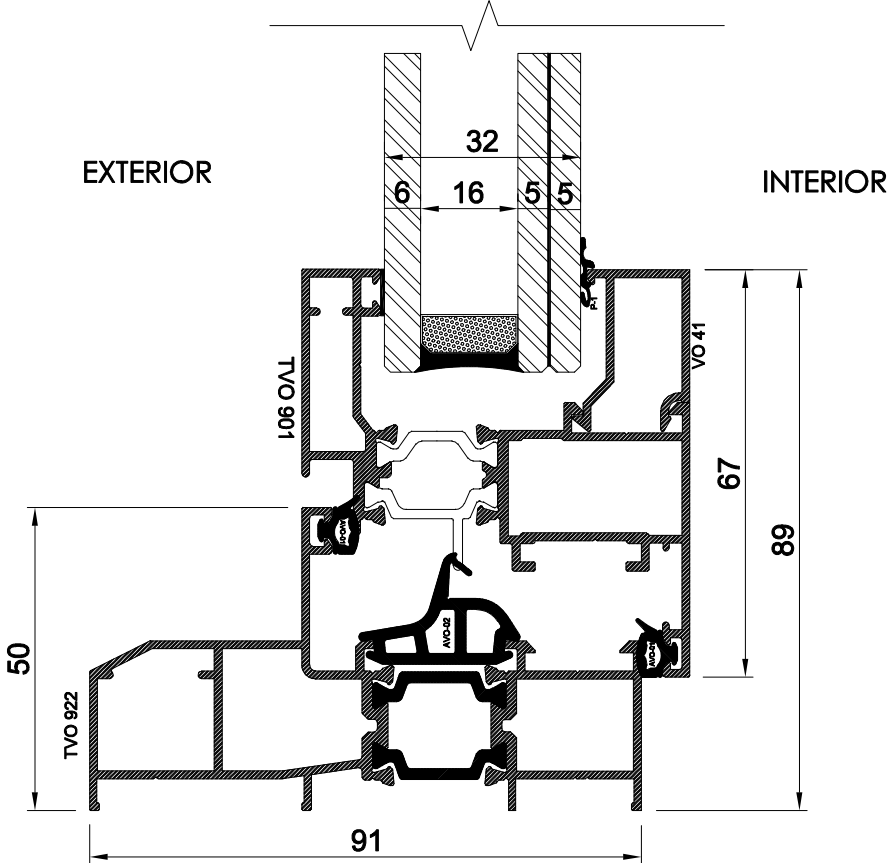

Section A-A, B-B Frame TVO-922 Sash TVO-901



Report #: P2842-116-45

Date: 11/23/2022

Verified by: *Megan M. Young*

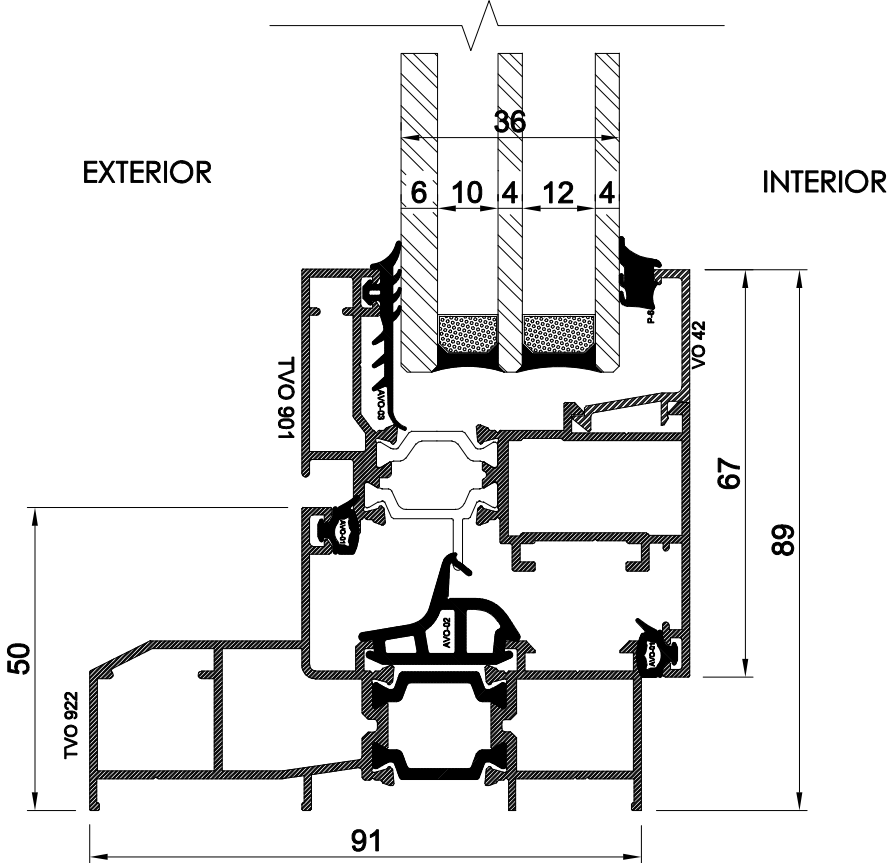

Section A-A, B-B Frame TVO-922 Sash TVO-901



Report #: P2842-116-45

Date: 11/23/2022

Verified by: *Megan M. Young*

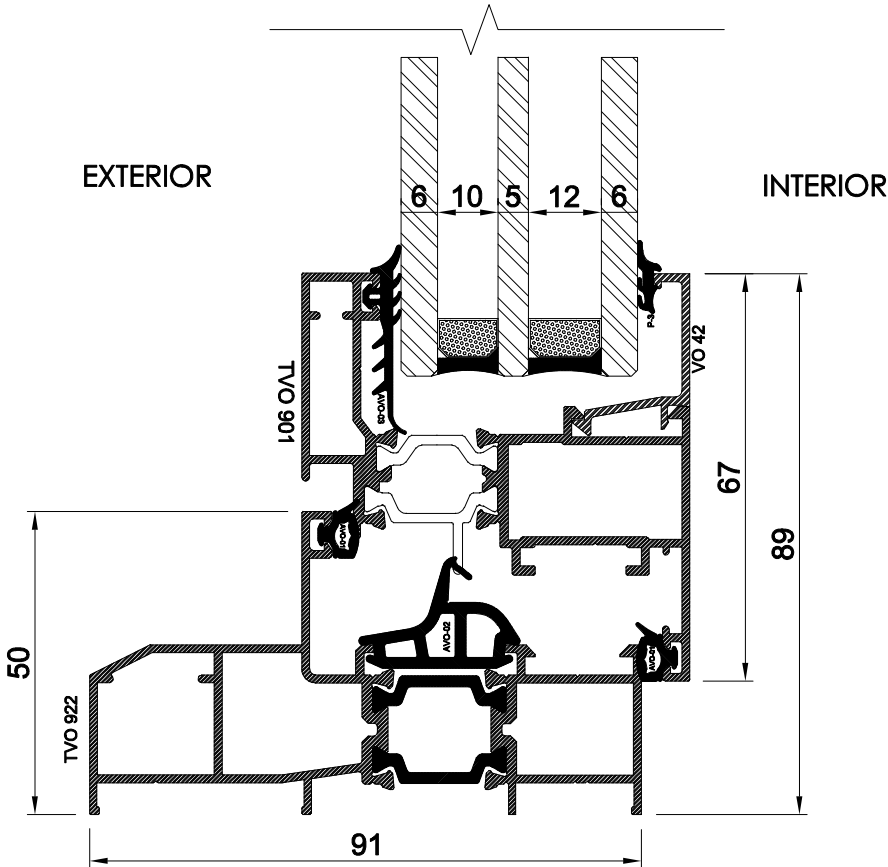

Section A-A, B-B Frame TVO-922 Sash TVO-911



Report #: P2842-116-45

Date: 11/23/2022

Verified by: *Megan M. Young*

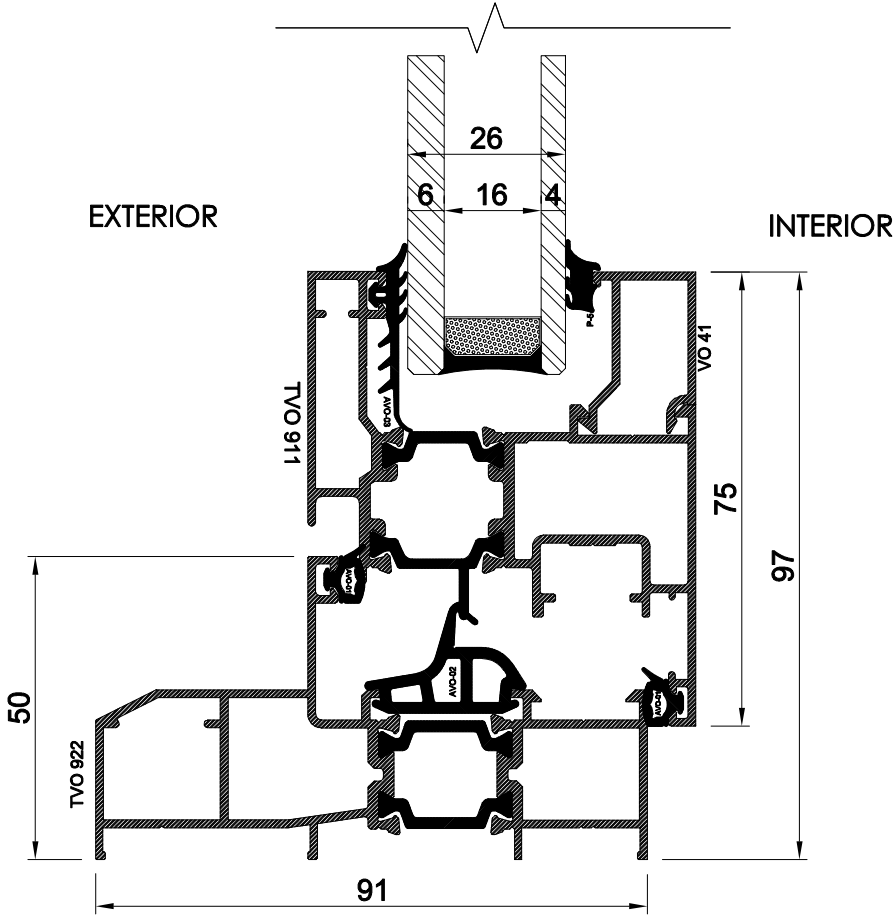

Section A-A, B-B Frame TVO-922 Sash TVO-911



Report #: P2842-116-45

Date: 11/23/2022

Verified by: *Megan M. Young*

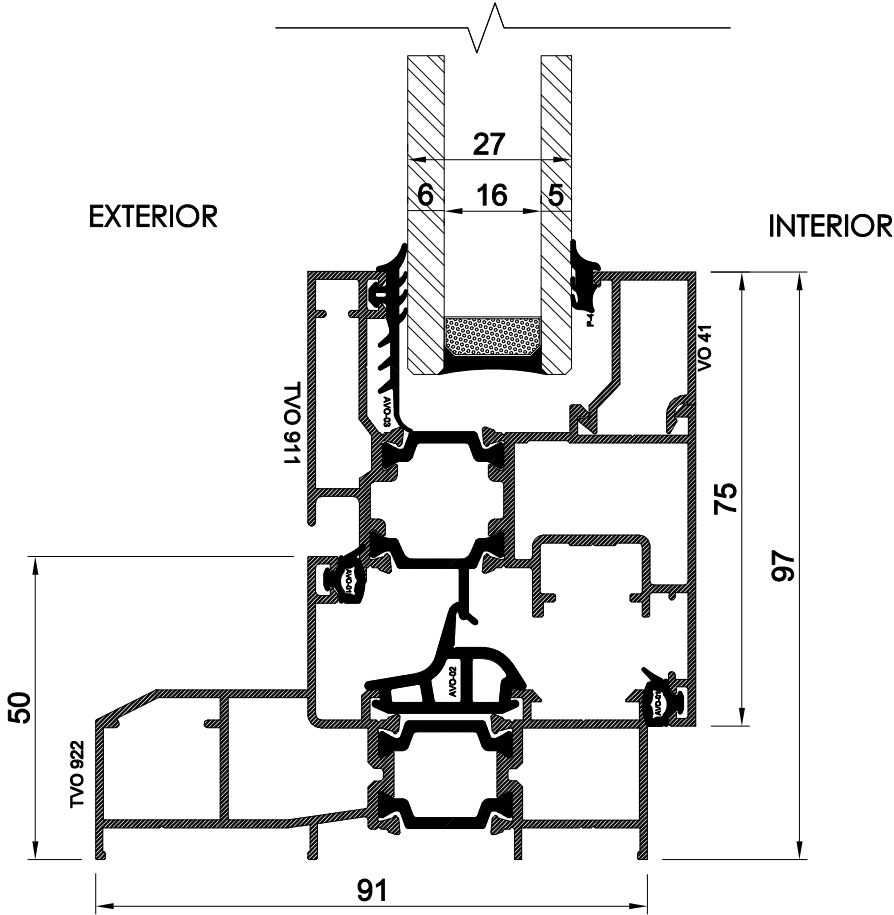

Section A-A, B-B Frame TVO-922 Sash TVO-911



Report #: P2842-116-45

Date: 11/23/2022

Verified by: *Megan M. Young*

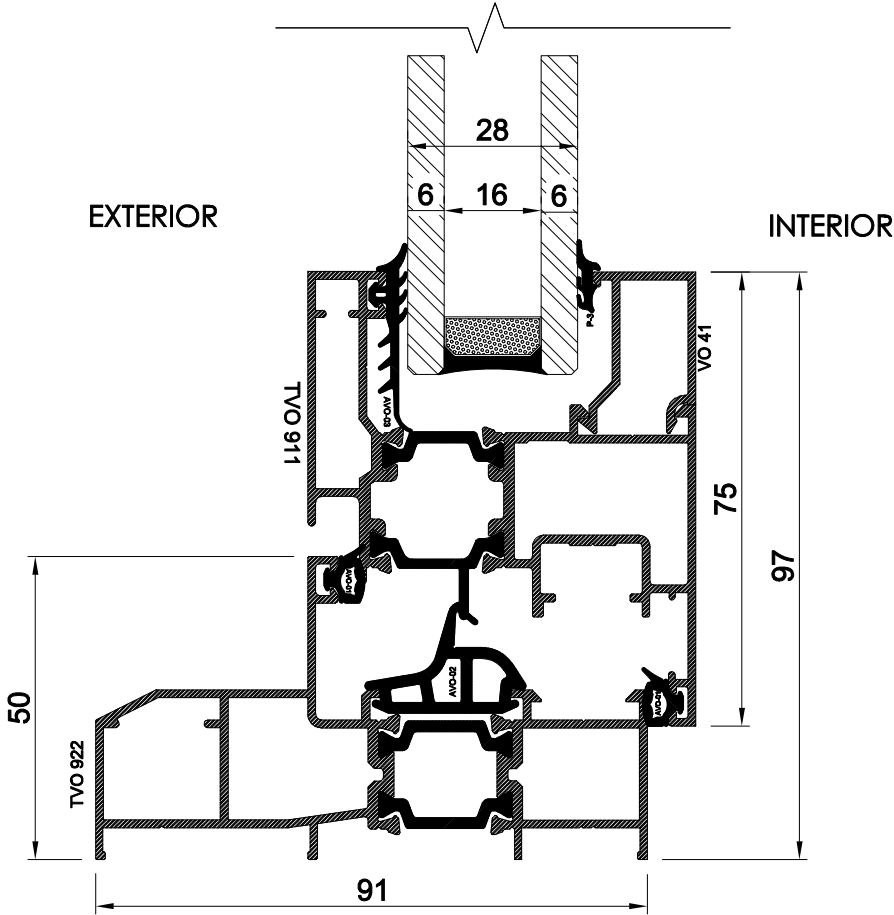

Section A-A, B-B Frame TVO-922 Sash TVO-911



Report #: P2842-116-45

Date: 11/23/2022

Verified by: *Megan M. Young*

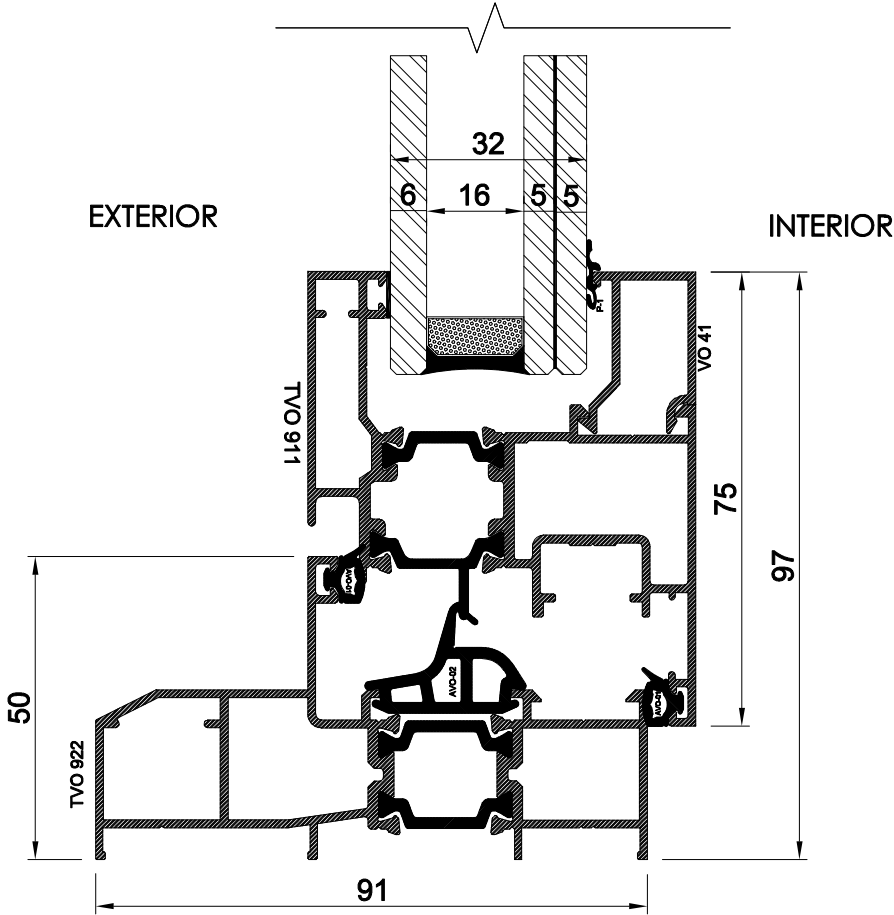

Section A-A, B-B Frame TVO-922 Sash TVO-911



Report #: P2842-116-45

Date: 11/23/2022

Verified by: *Megan M. Young*

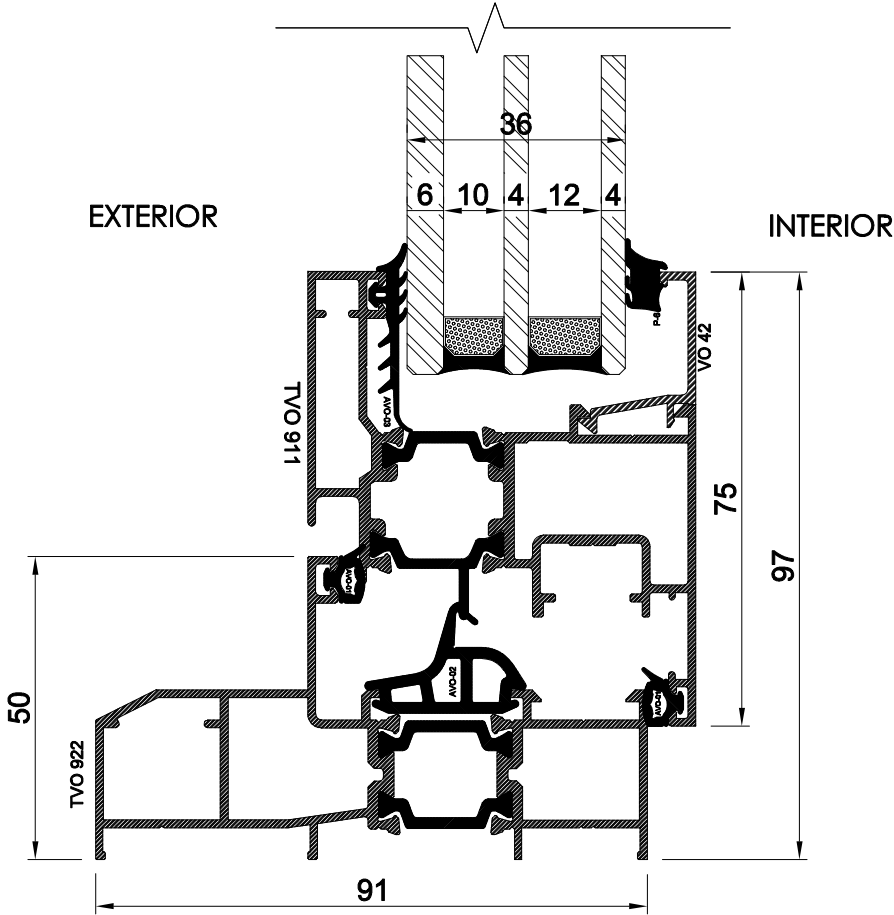

Section A-A, B-B Frame TVO-922 Sash TVO-911



Report #: P2842-116-45

Date: 11/23/2022

Verified by: *Megan M. Young*

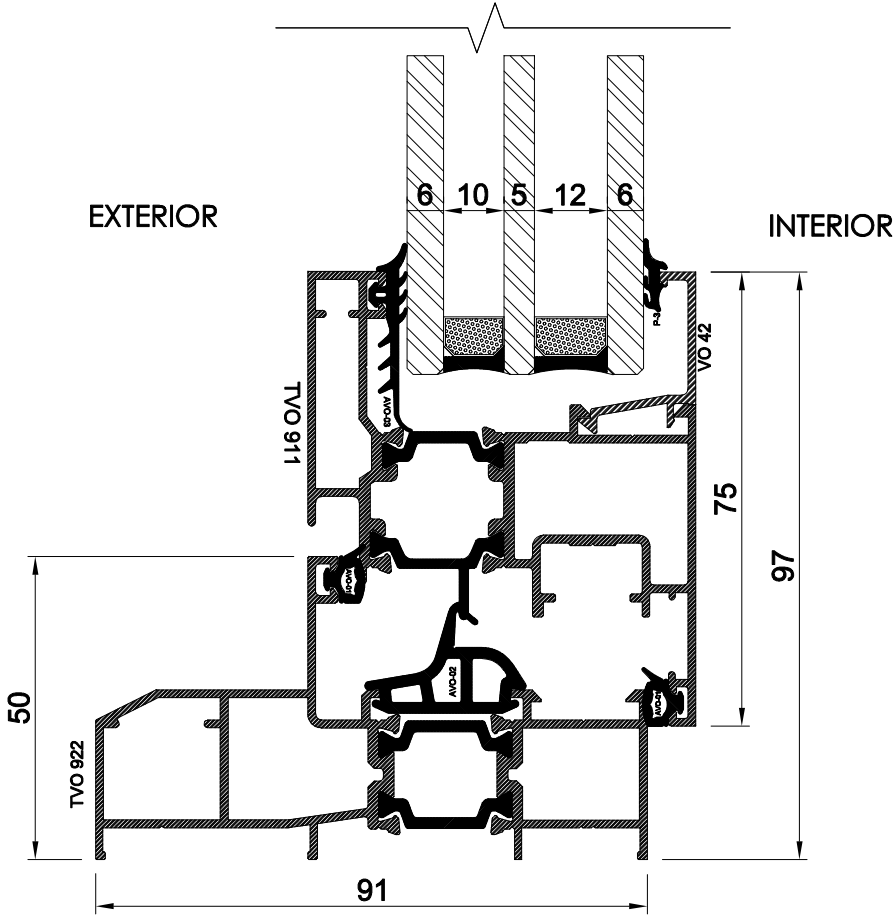

Section A-A, B-B Frame TVO-927 Sash TVO-901



Report #: P2842-116-45

Date: 11/23/2022

Verified by: *Megan M. Young*

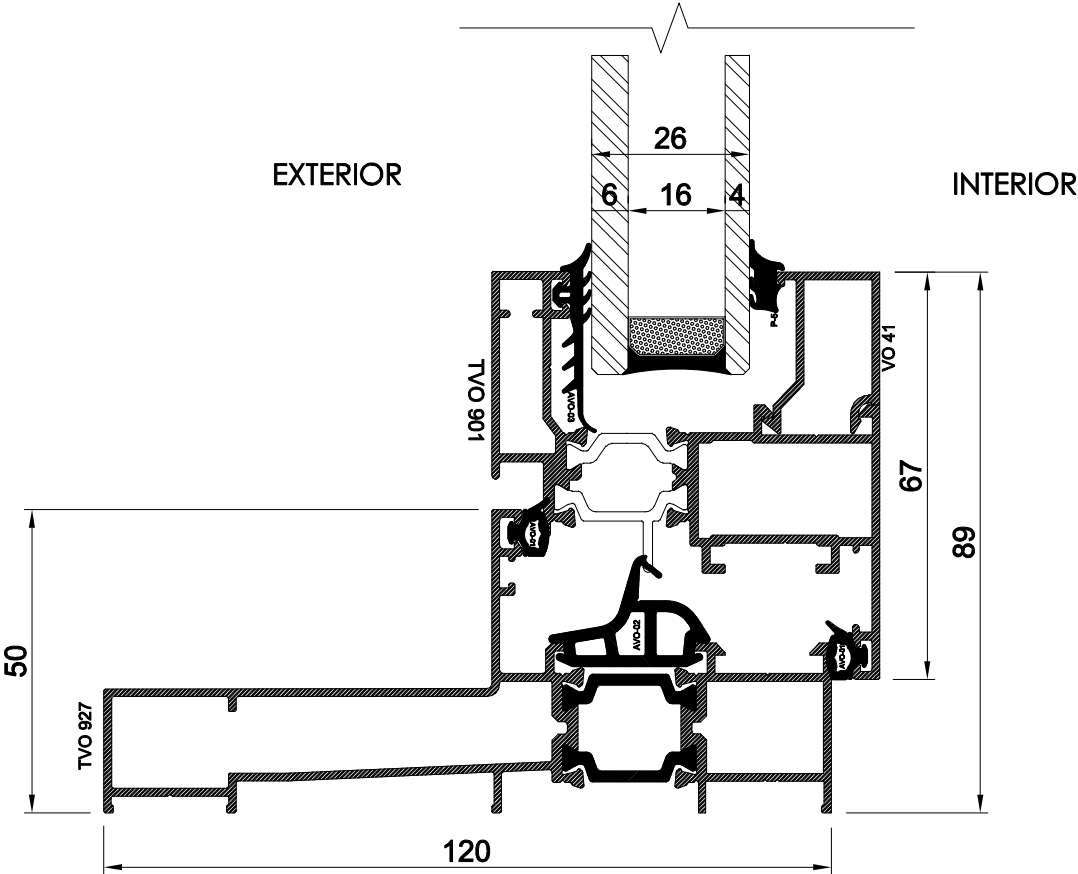

Section A-A, B-B Frame TVO-927 Sash TVO-901



Report #: P2842-116-45

Date: 11/23/2022

Verified by: *Megan M. Young*

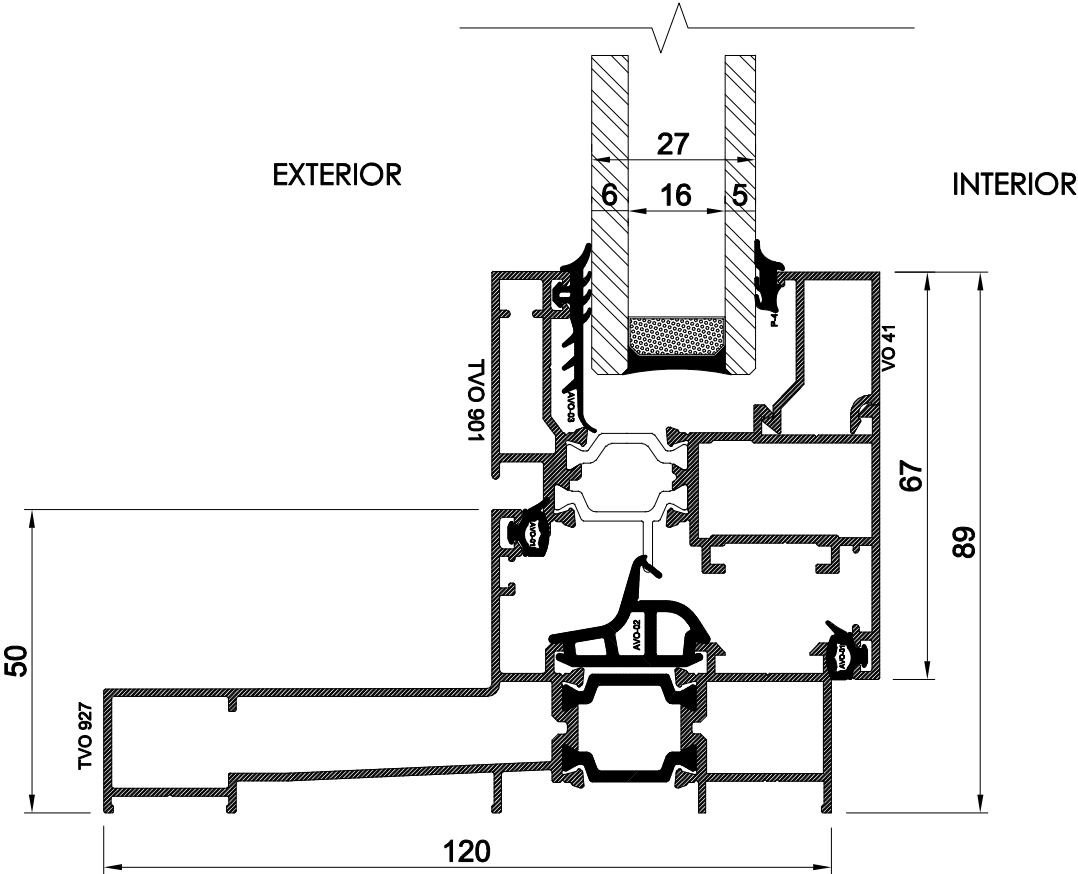

Section A-A, B-B Frame TVO-927 Sash TVO-901



Report #: P2842-116-45

Date: 11/23/2022

Verified by: *Megan M. Young*

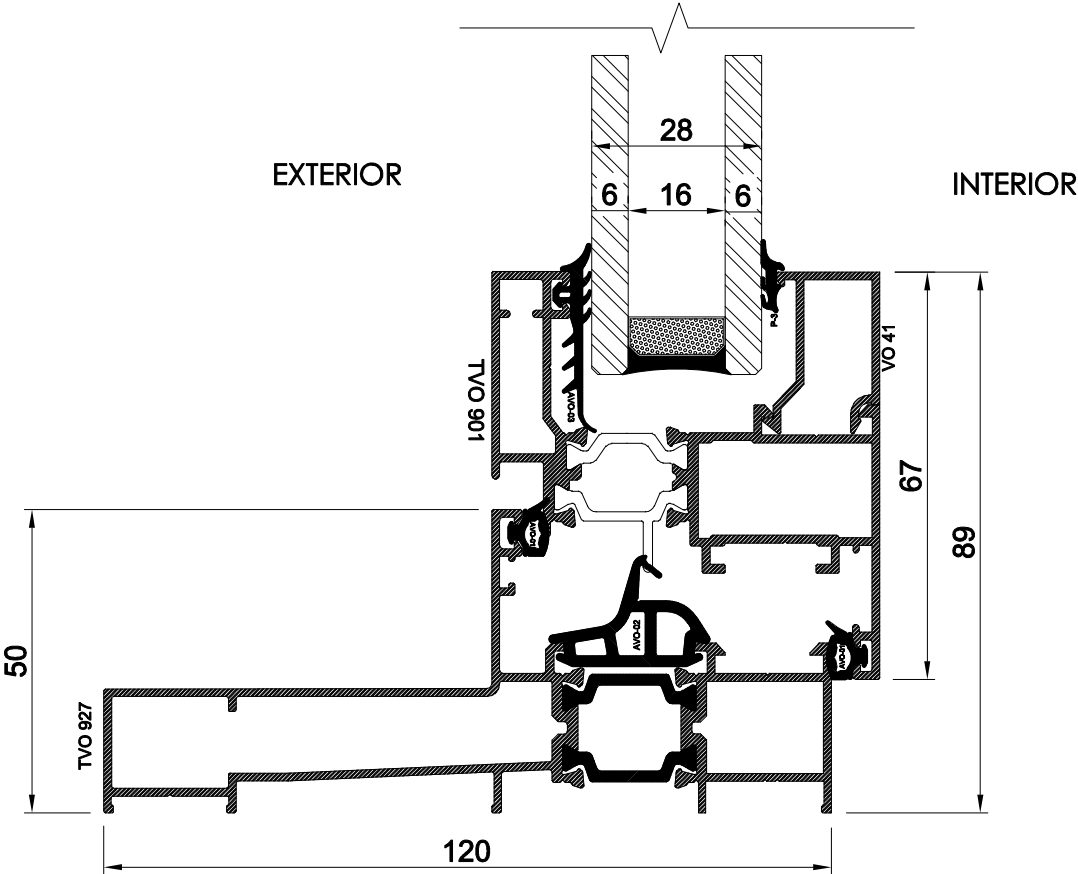

Section A-A, B-B Frame TVO-927 Sash TVO-901



Report #: P2842-116-45

Date: 11/23/2022

Verified by: *Megan M. Young*

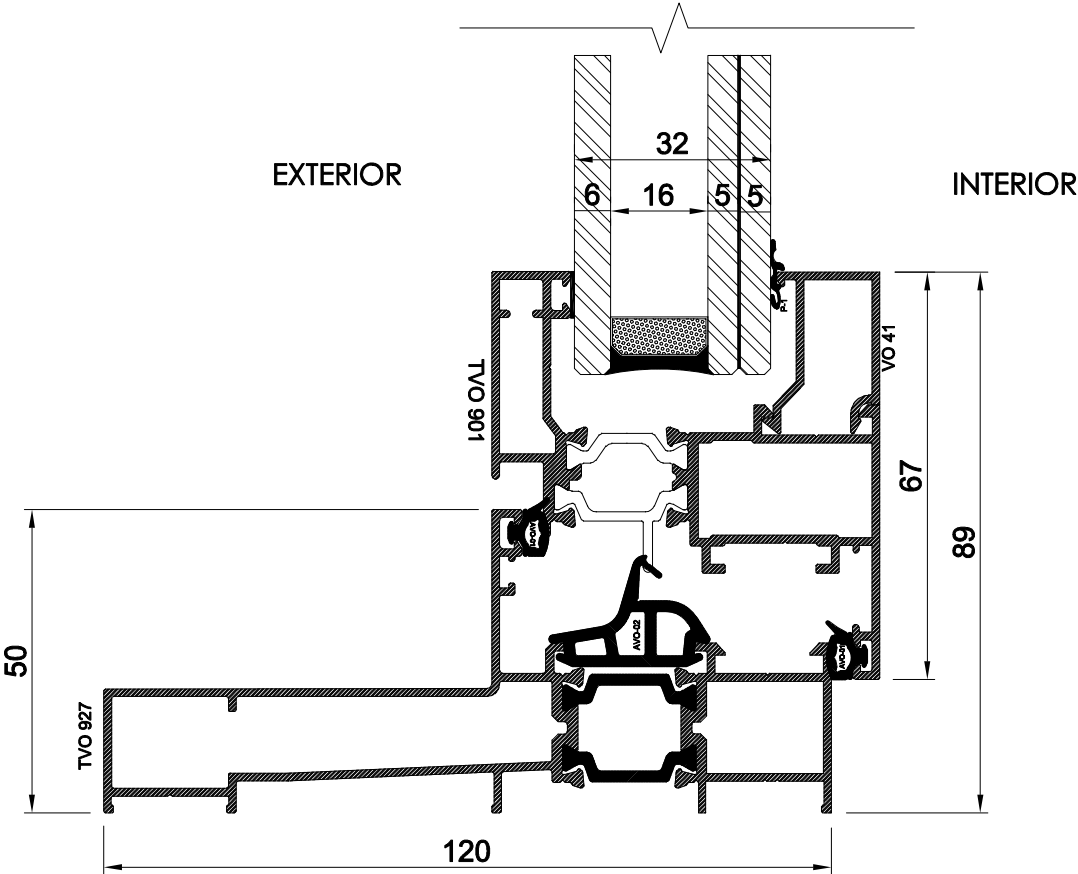

Section A-A, B-B Frame TVO-927 Sash TVO-901



Report #: P2842-116-45

Date: 11/23/2022

Verified by: *Megan M. Young*

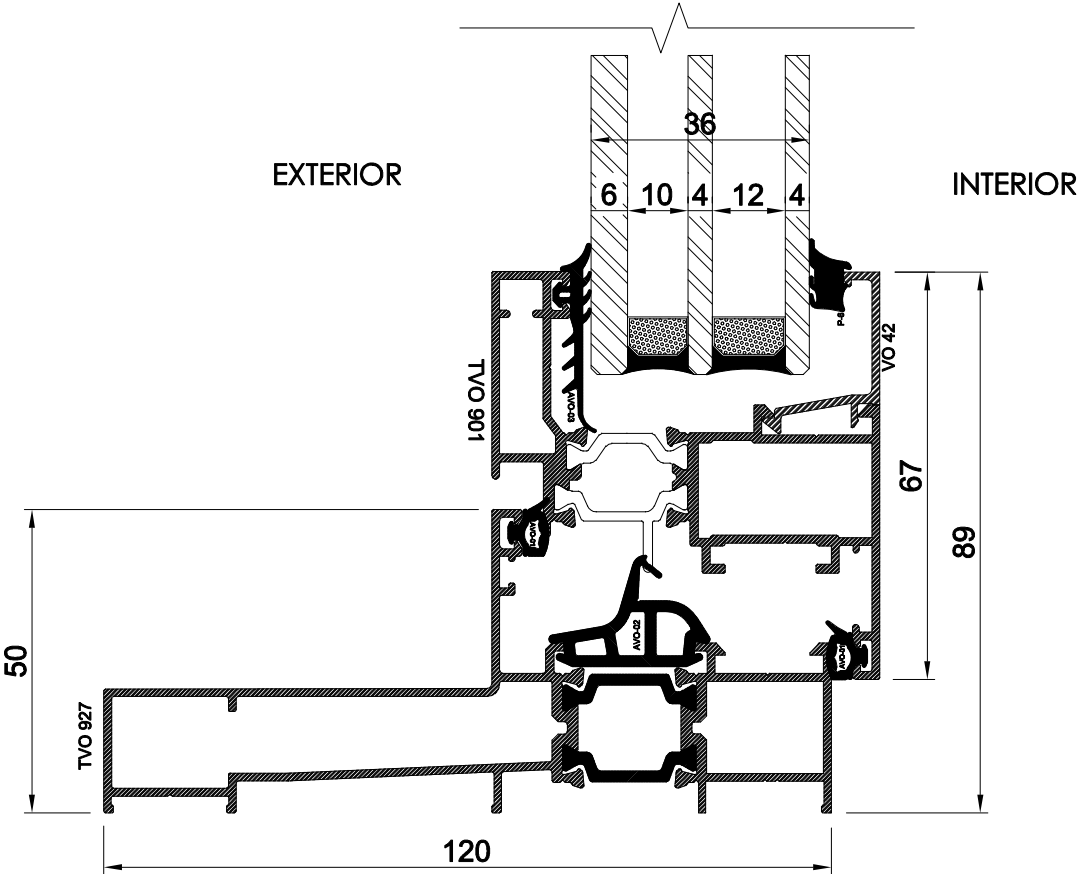

Section A-A, B-B Frame TVO-927 Sash TVO-901



Report #: P2842-116-45

Date: 11/23/2022

Verified by: *Megan M. Young*

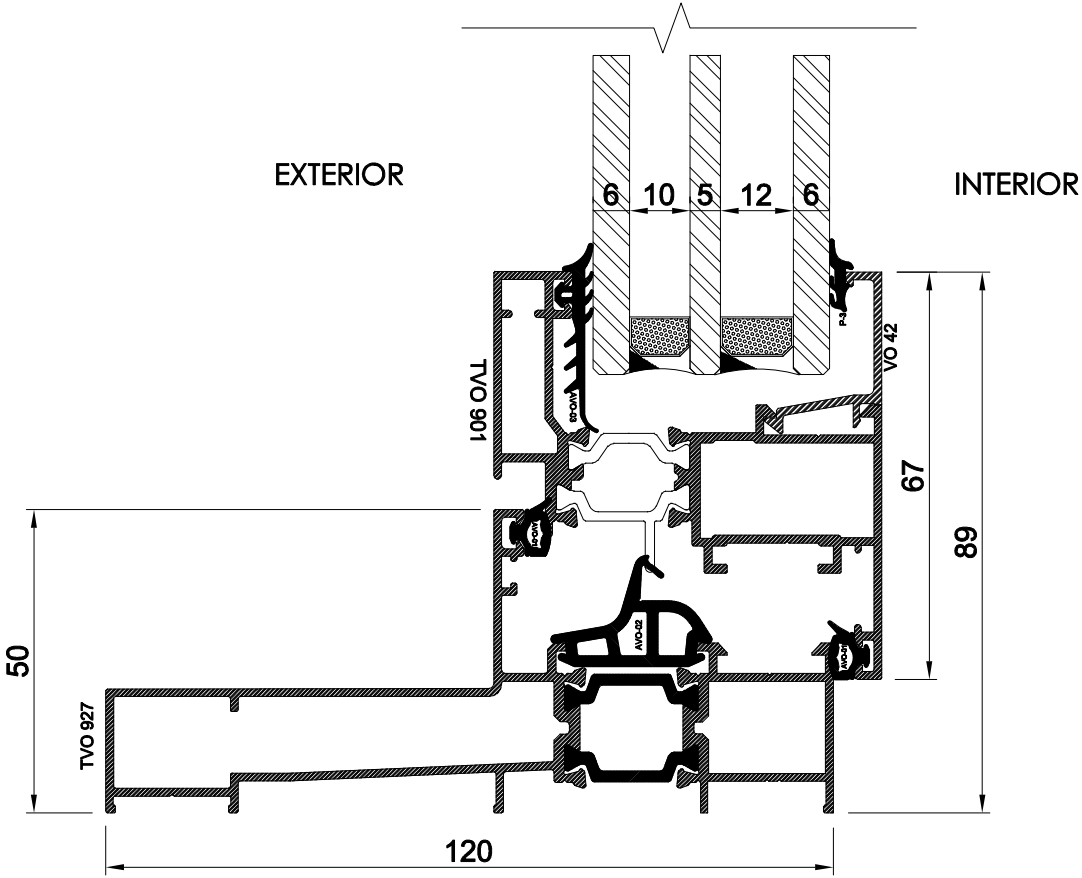

Section A-A, B-B Frame TVO-927 Sash TVO-911



Report #: P2842-116-45

Date: 11/23/2022

Verified by: *Megan M. Young*

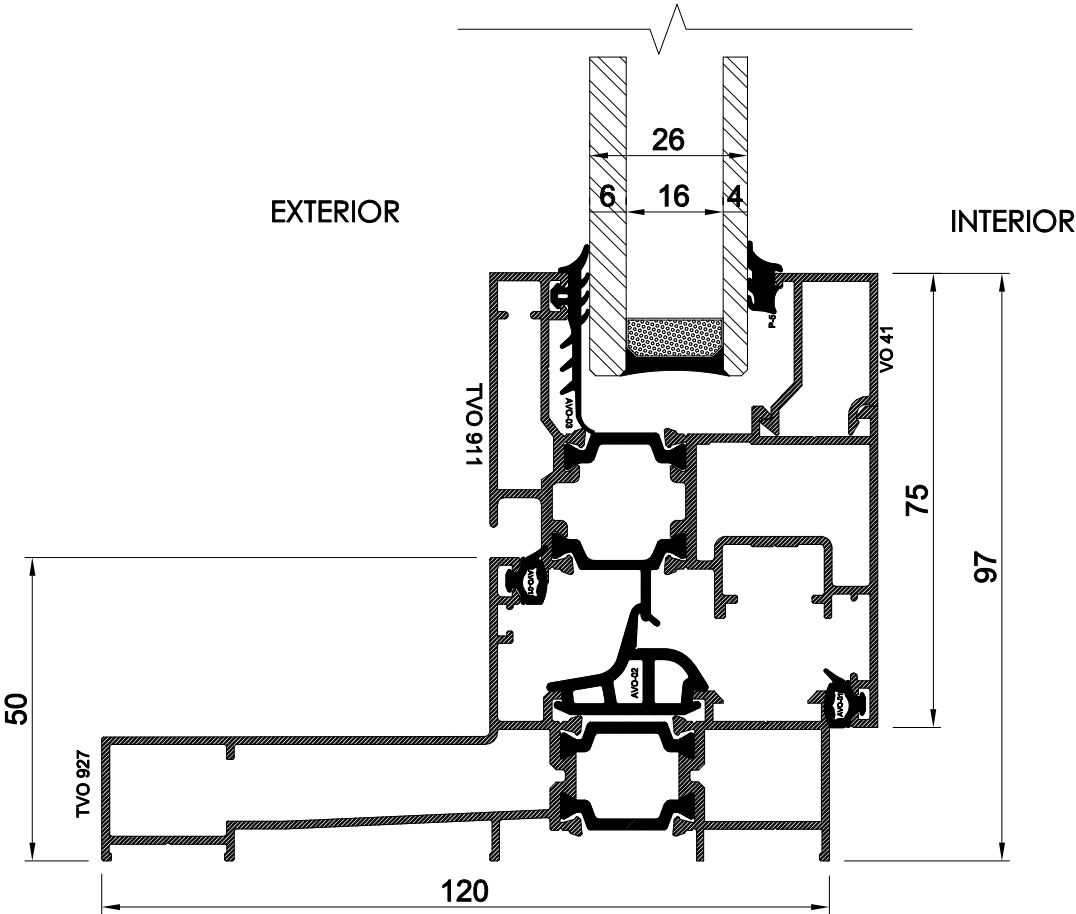

Section A-A, B-B Frame TVO-927 Sash TVO-911



Report #: P2842-116-45

Date: 11/23/2022

Verified by: *Megan M. Young*

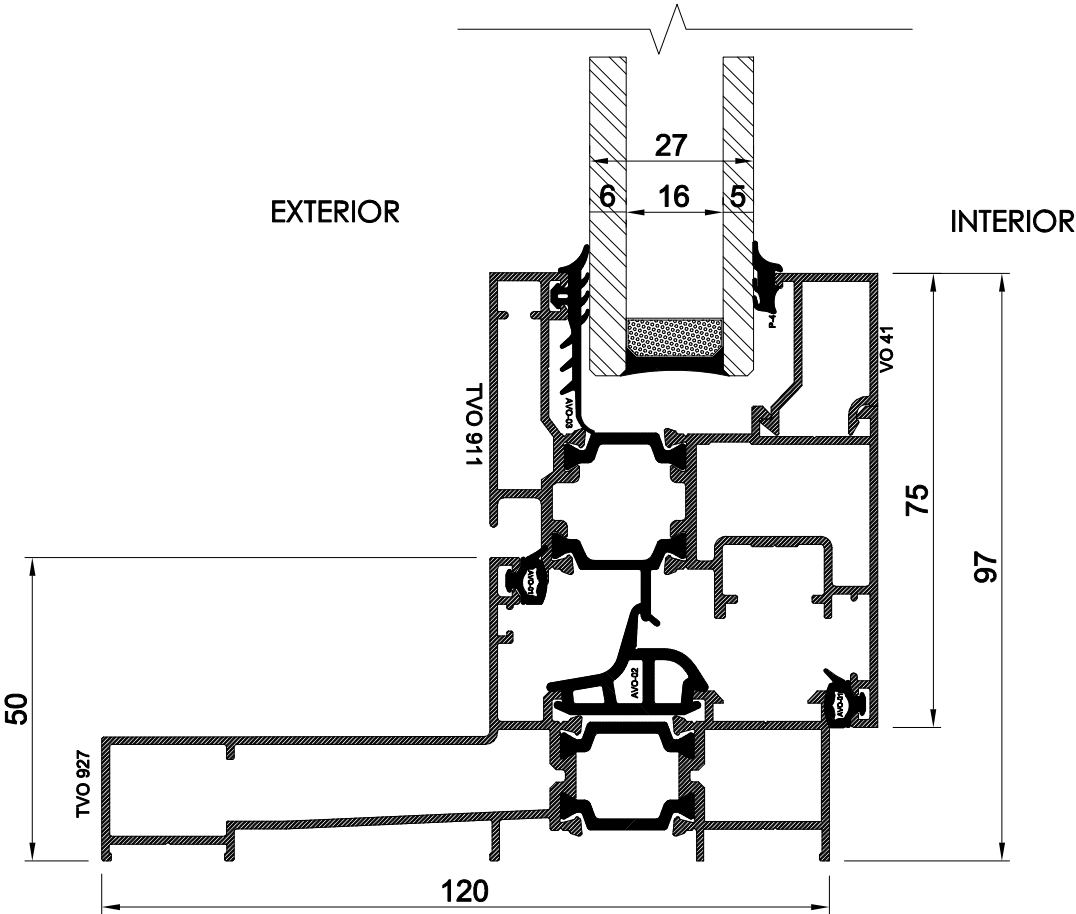

Section A-A, B-B Frame TVO-927 Sash TVO-911



Report #: P2842-116-45

Date: 11/23/2022

Verified by: *Megan M. Young*

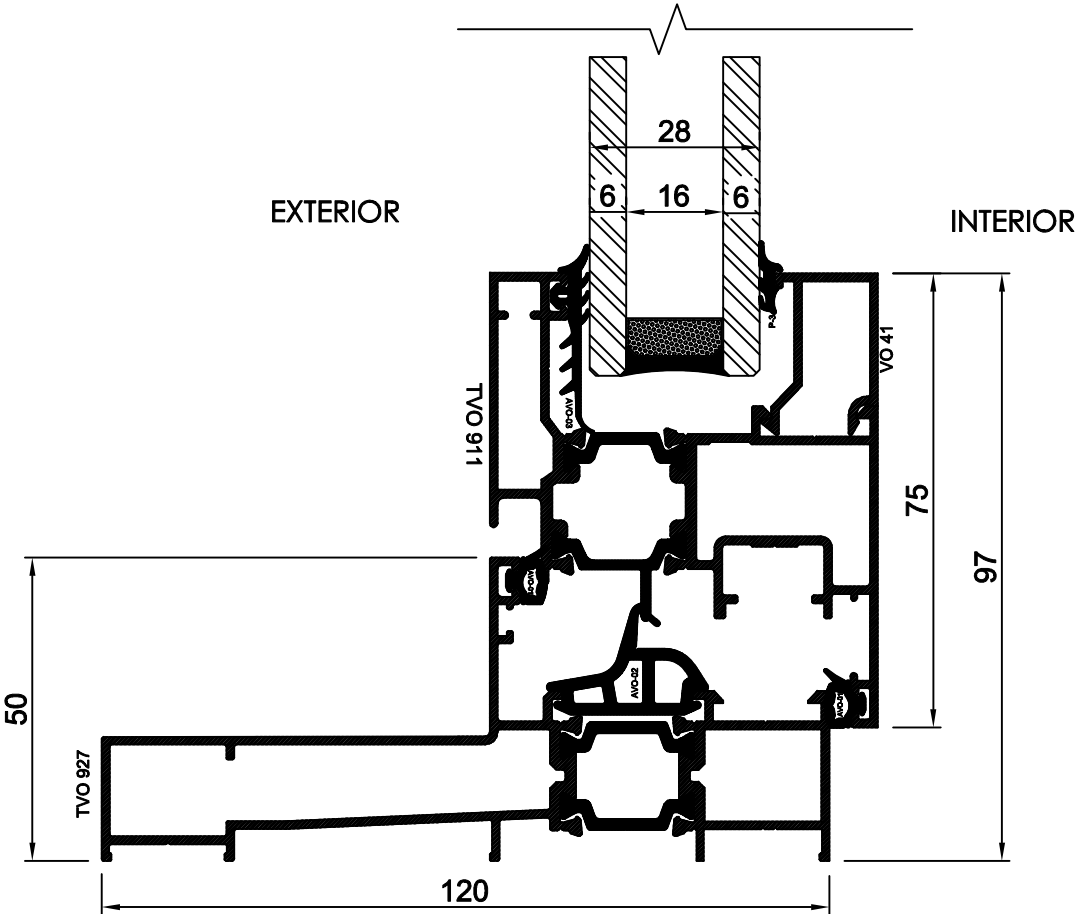

Section A-A, B-B Frame TVO-927 Sash TVO-911



Report #: P2842-116-45

Date: 11/23/2022

Verified by: *Megan M. Young*

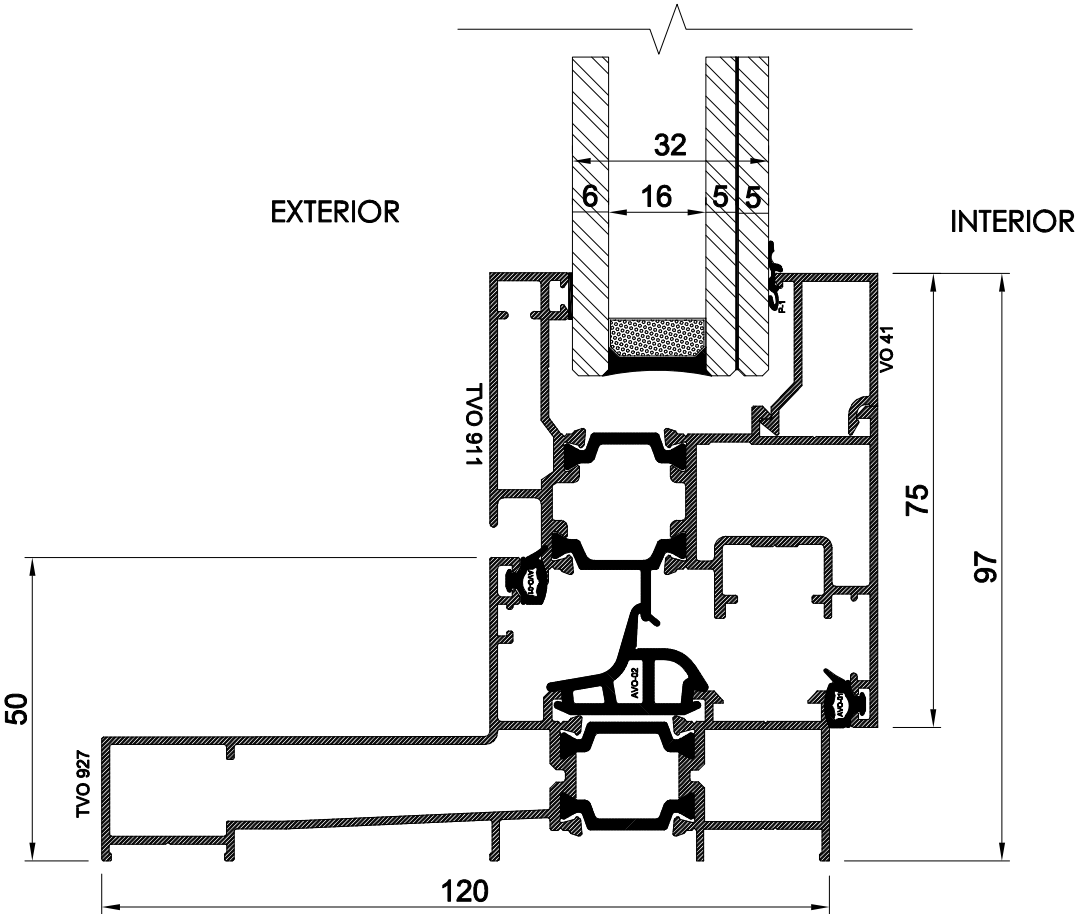

Section A-A, B-B Frame TVO-927 Sash TVO-911



Report #: P2842-116-45

Date: 11/23/2022

Verified by: *Megan M. Young*

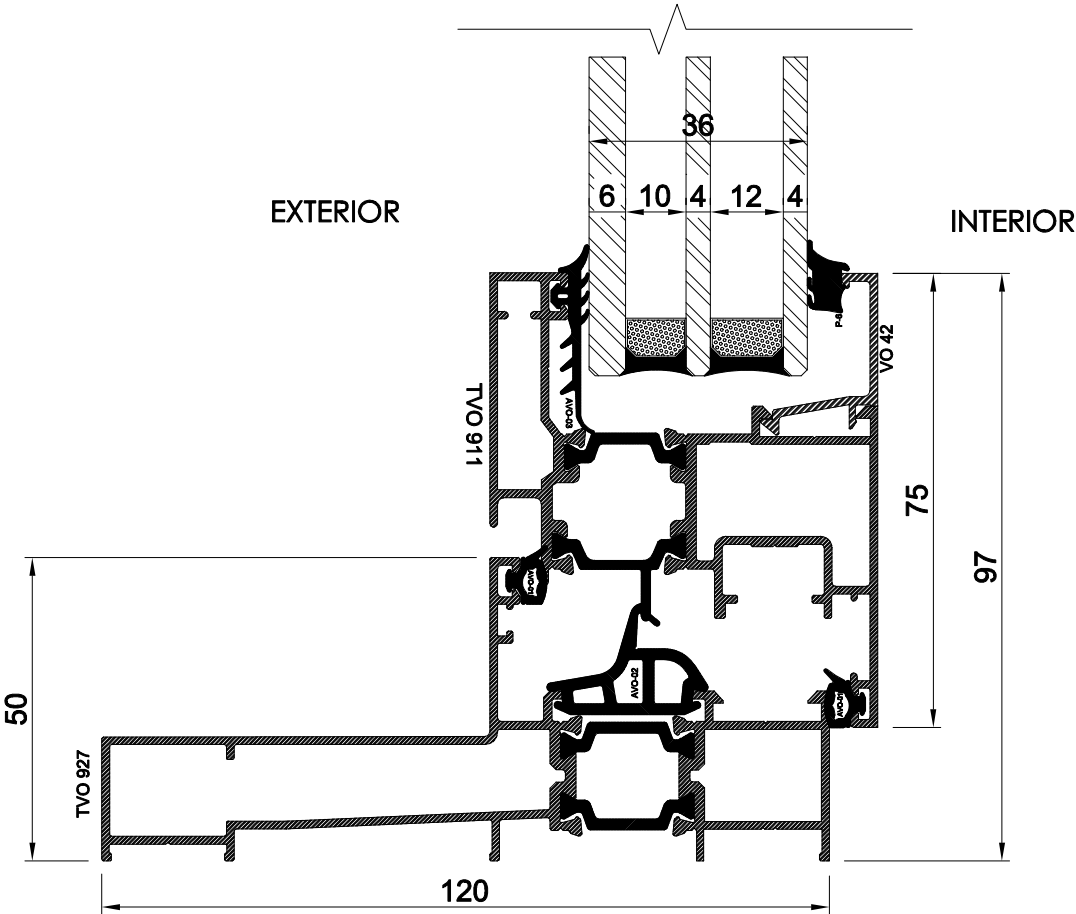

Section A-A, B-B Frame TVO-927 Sash TVO-911



Report #: P2842-116-45

Date: 11/23/2022

Verified by: *Megan M. Young*

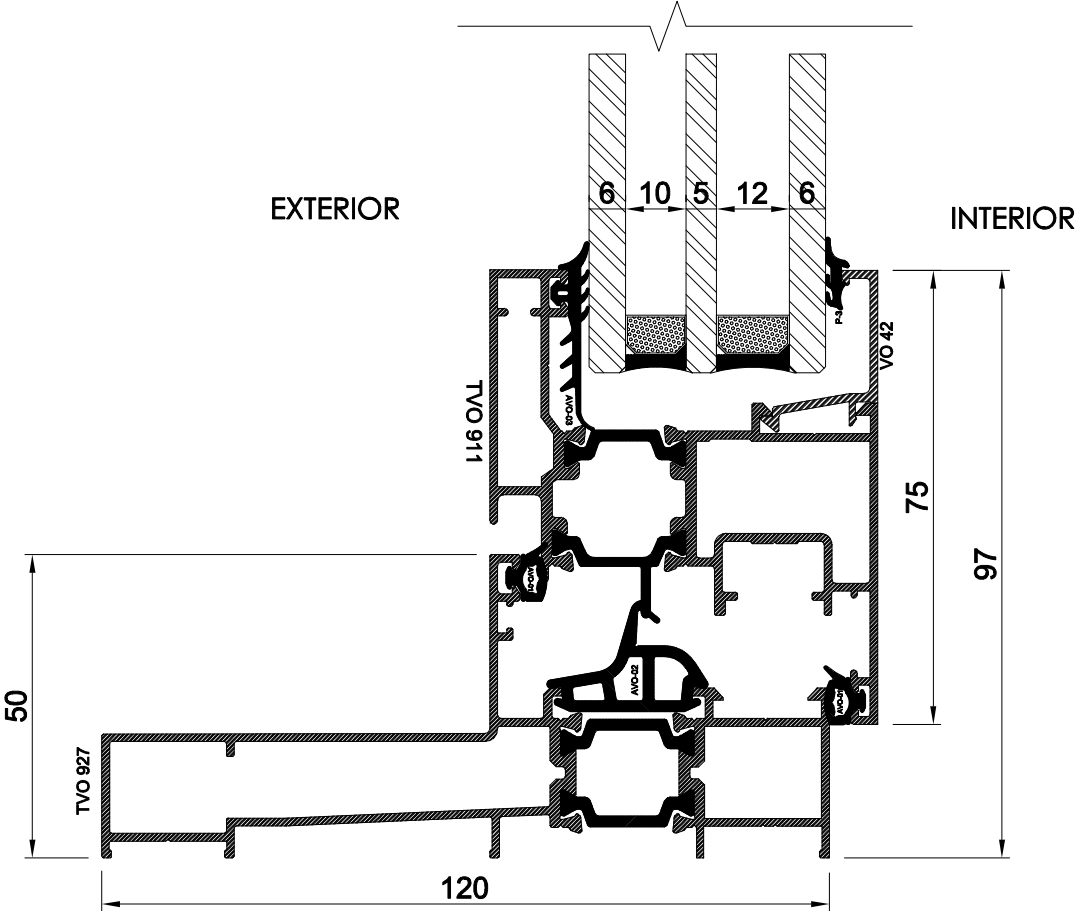

Frame TVO-921

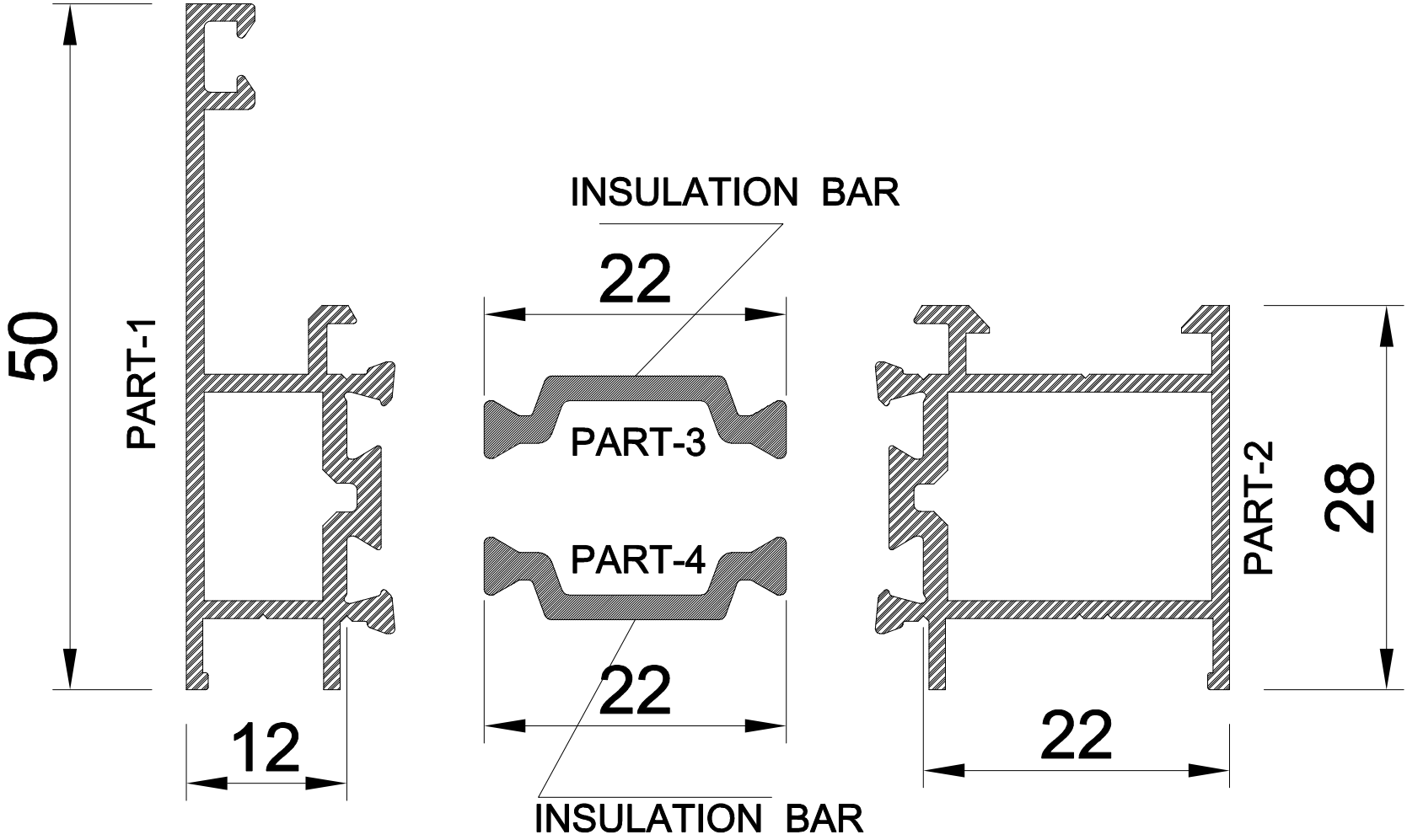

Parts 1&2 = Painted or Anodized Aluminum
Parts 3&4 = Polyamide

Frame TVO-922

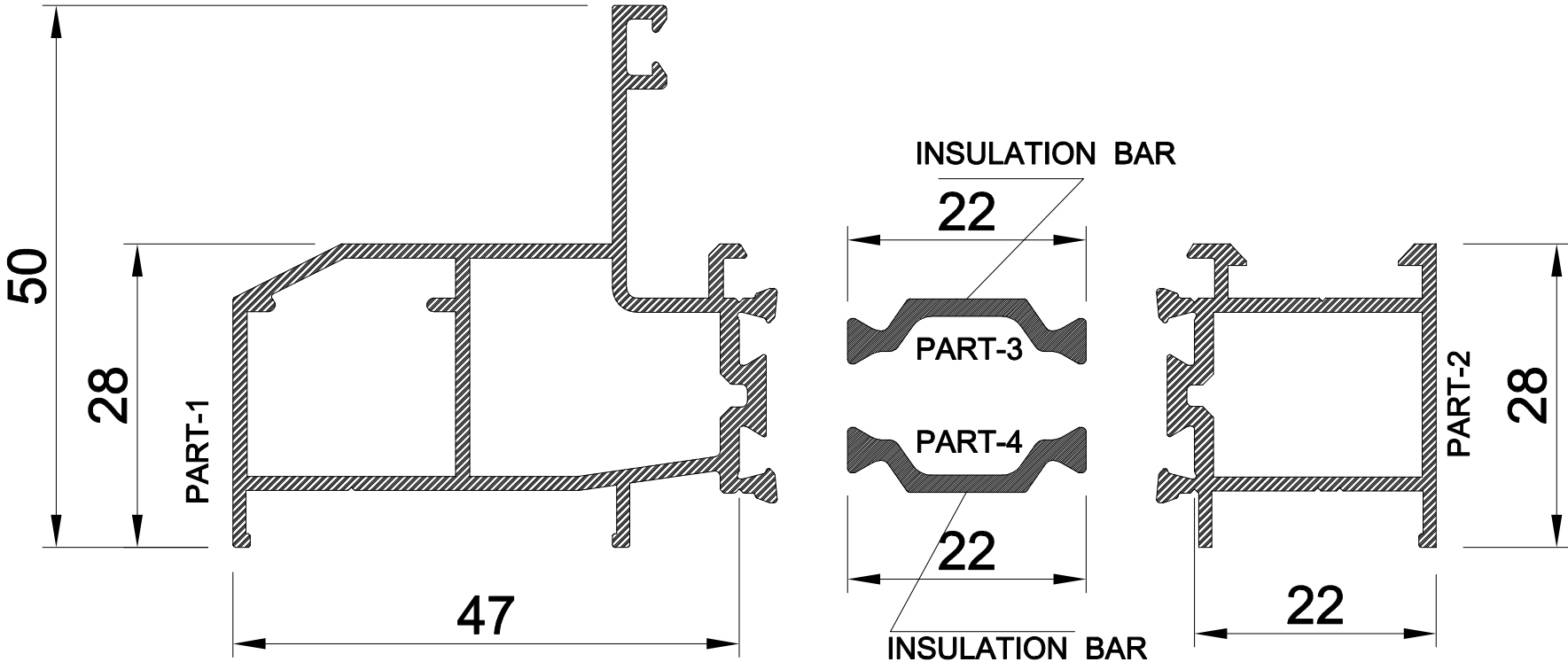

Parts 1&2 = Painted or Anodized Aluminum
Parts 3&4 = Polyamide

Frame TVO-927

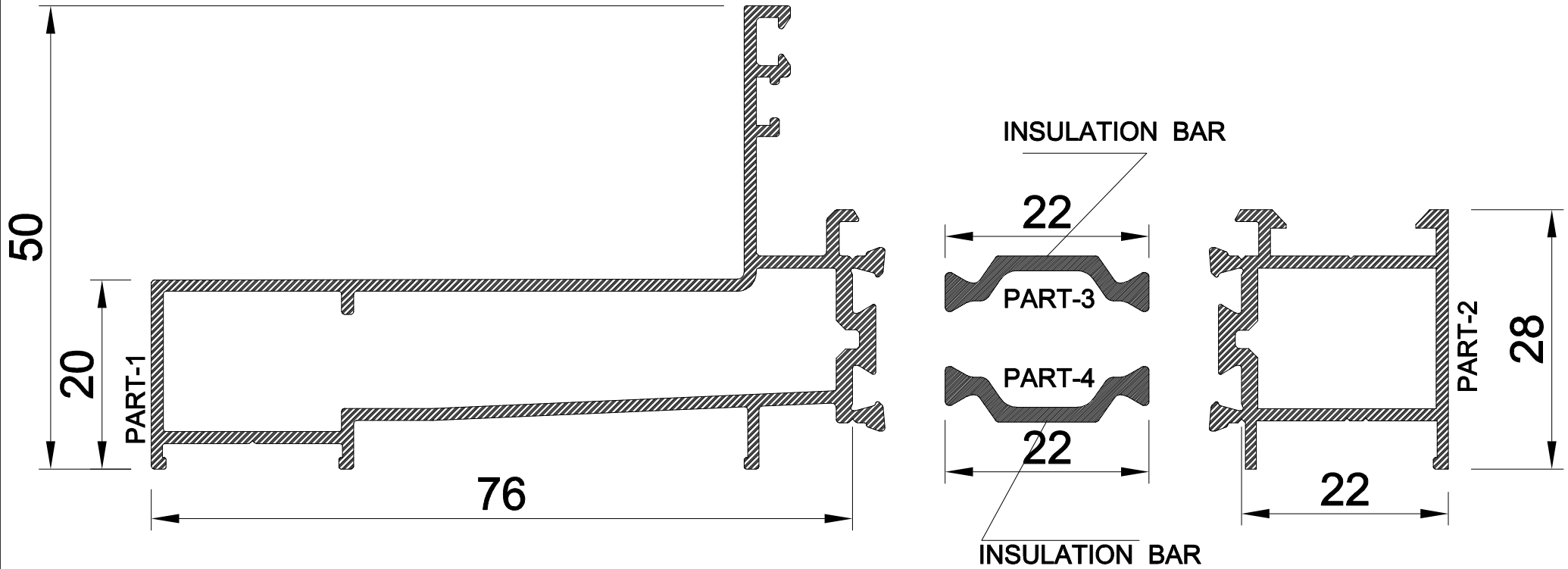

Parts 1&2 = Painted or Anodized Aluminum
Parts 3&4 = Polyamide

GASKETS (EPDM)

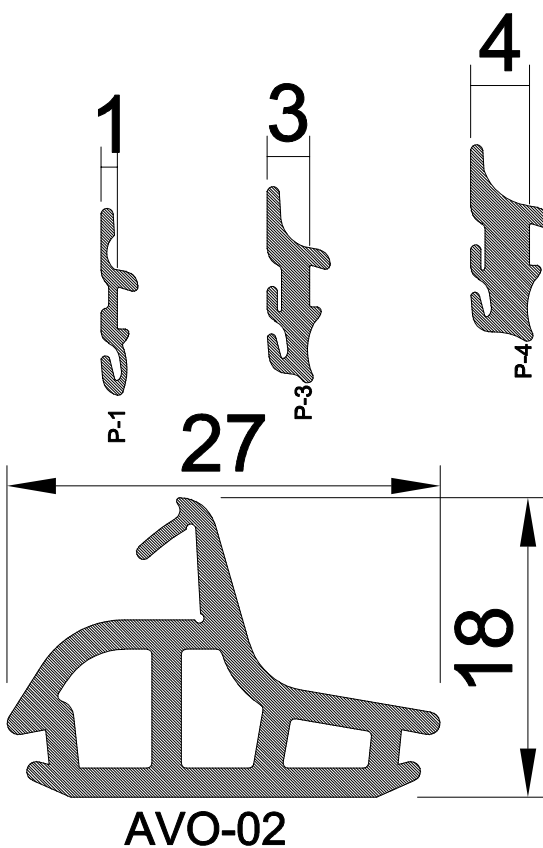
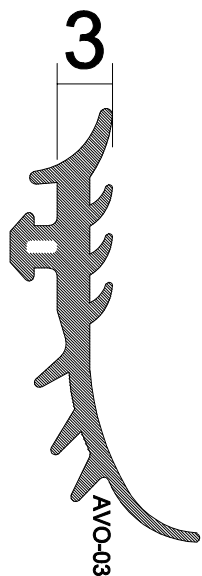

GLAZING BEAD VO-41

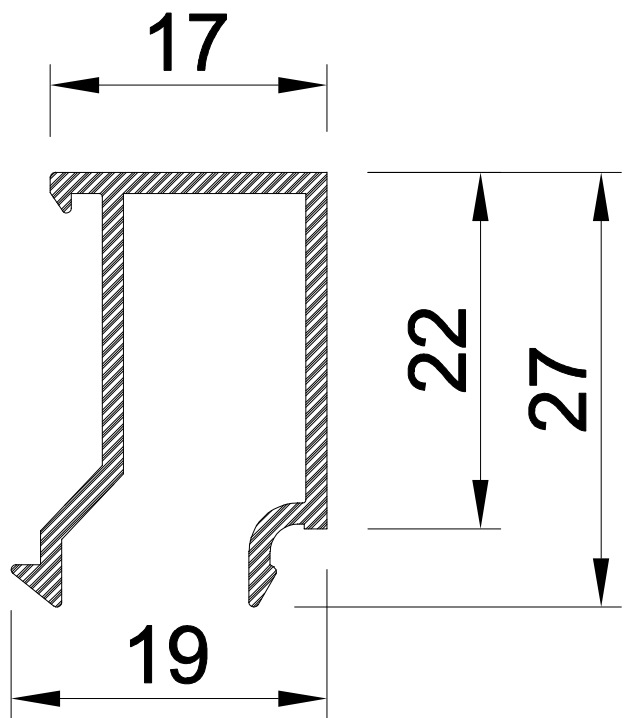

Material = Painted or Anodized Aluminum

GLAZING BEAD VO-42

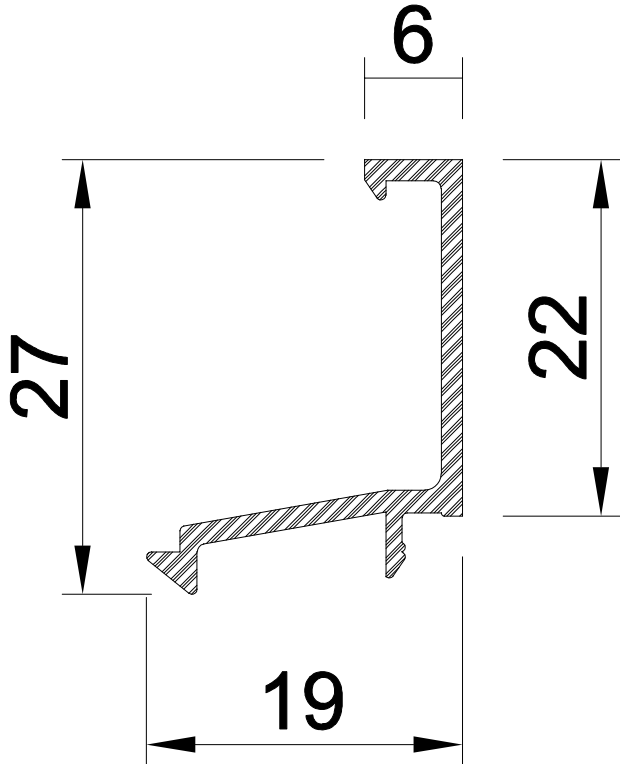

Material = Painted or Anodized Aluminum

Sash TVO-901

intertek	Report #: P2842-116-45
	Date: 11/23/2022
	Verified by: <i>Megan M. Young</i>

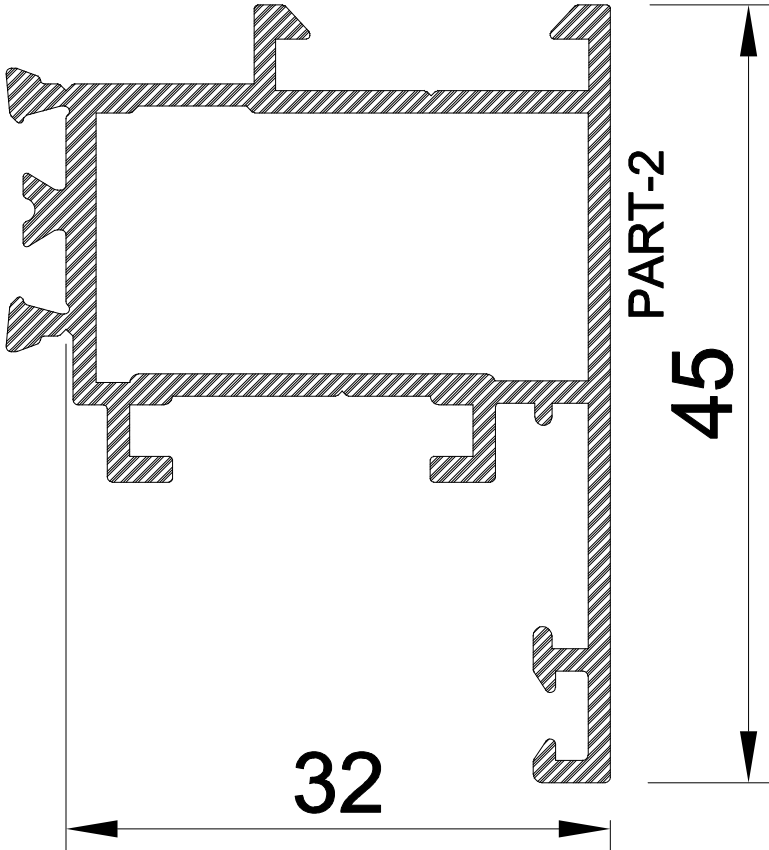
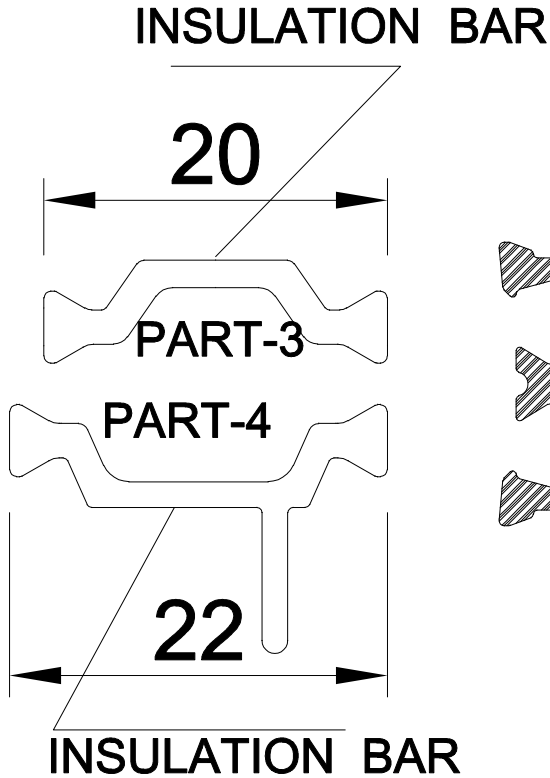
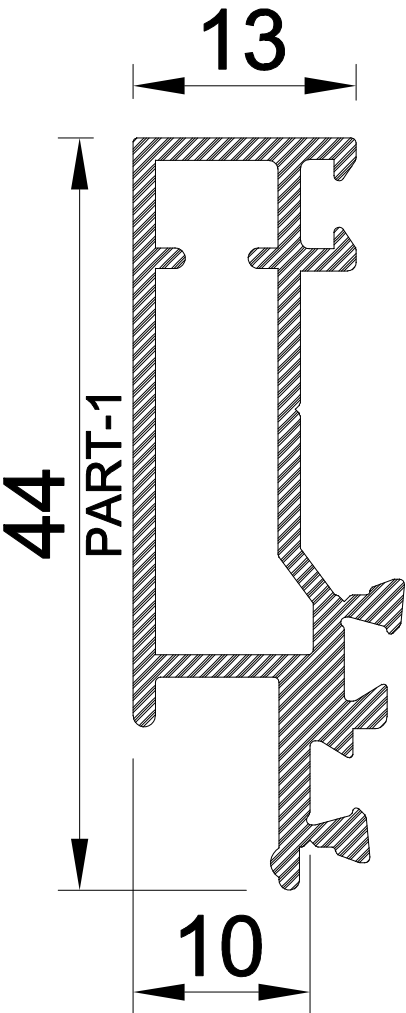

Parts 1&2 = Painted or Anodized Aluminum
Parts 3&4 = Polyamide

Sash TVO-911

	Report #: P2842-116-45
	Date: 11/23/2022
	Verified by: <i>Megan M. Young</i>

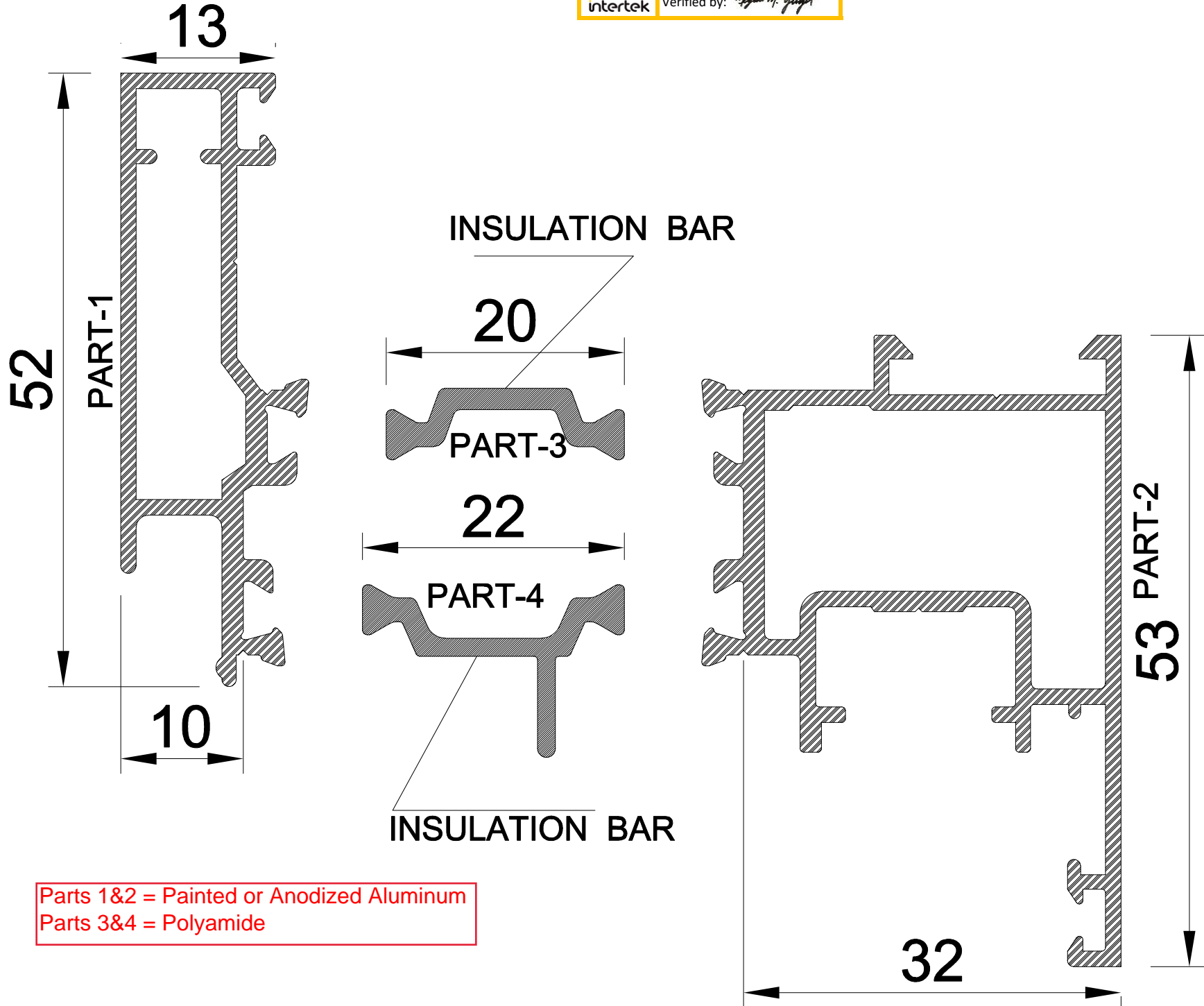

Parts 1&2 = Painted or Anodized Aluminum
Parts 3&4 = Polyamide



Report #: P2842-116-45

Date: 11/23/2022

Verified by: *Megan M. Young*

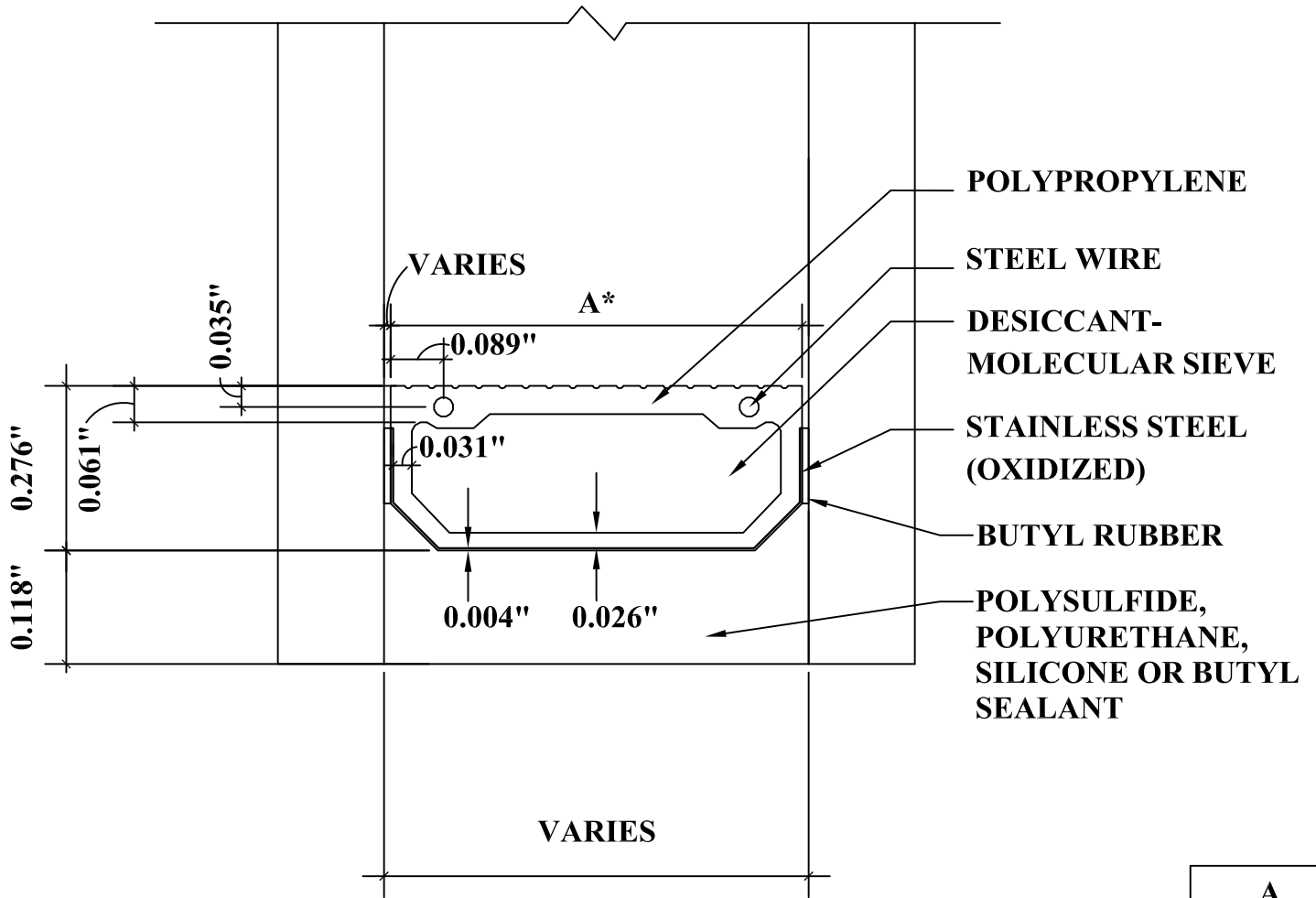

DETAIL FOR THERMAL MODELING OF ENSINGER THERMIX TX.N PLUS SPACER (TS-D)

***SPACER AVAILABLE IN 10 SIZES.**

A
0.945"
0.866"
0.787"
0.709"
0.630"
0.591"
0.551"
0.472"
0.394"
0.315"



Report #: P2842-116-45
Date: 11/23/2022
Verified by: *Megan M. Yung*

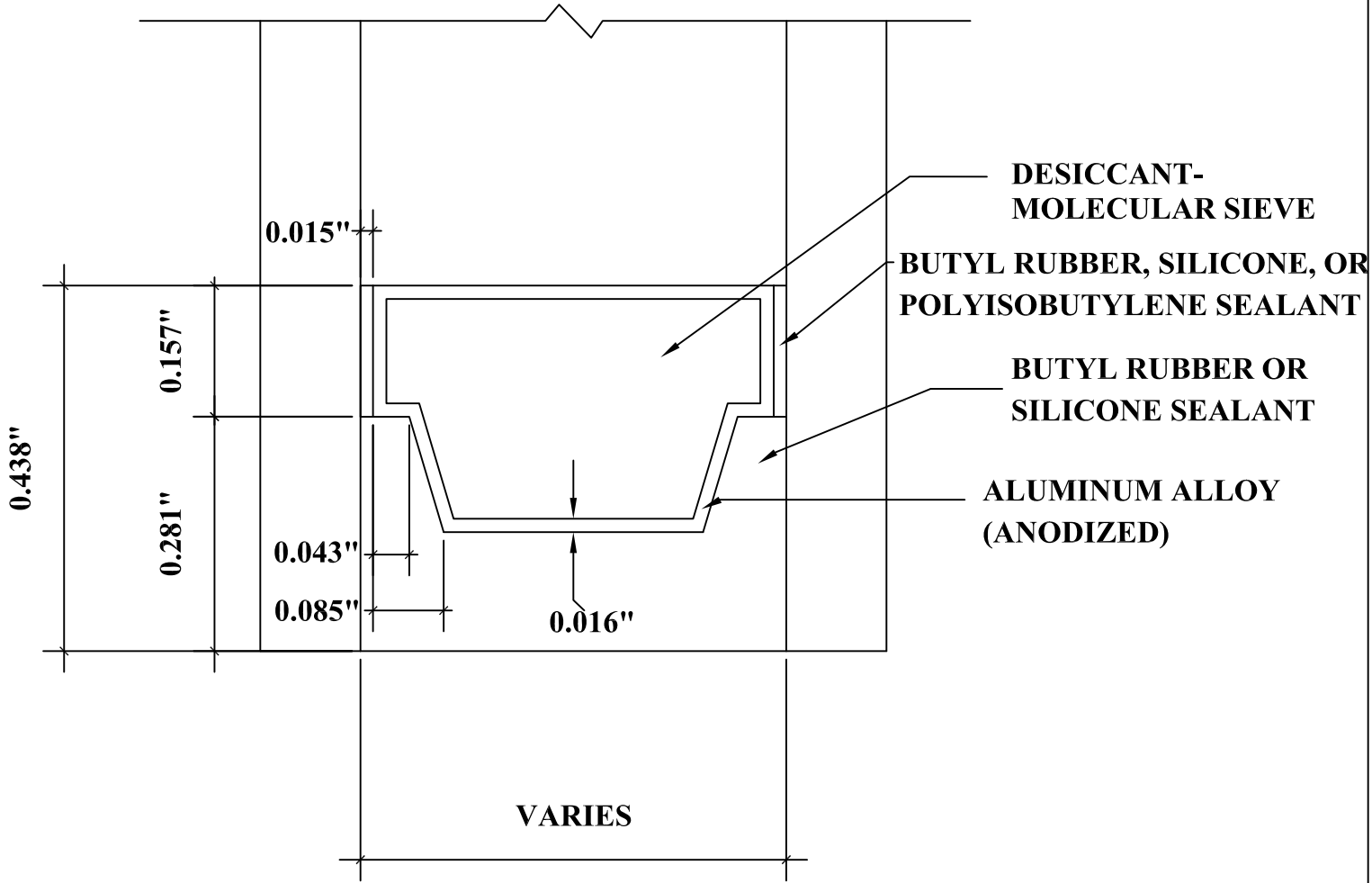

DETAIL FOR THERMAL MODELING OF ALUMINUM SPACER (A1-D)

TEST REPORT FOR NEON ENERGY

Report No: P2842.01-116-45 R1

Date: 02/28/23

SECTION 8

REVISION LOG

REVISION #	DATE	PAGES	REVISION
.01R0	11/23/22	All	Original report issued to Neon Energy.
.01R1	02/28/23	All	Fixed glass emissivities on some models and updated results.